



- IT | Istruzioni Di Montaggio
- GB | Assembly Instructions
- FR | Instructions de montage
- DE | Montageanleitung
- ES | Instrucciones de montaje

 <p>Min 0,5 Max 5</p>	 <p>Max 70°</p>
--	--

Non incluso | Not included | Non Inclus | Nicht enthalten | No incluido



1

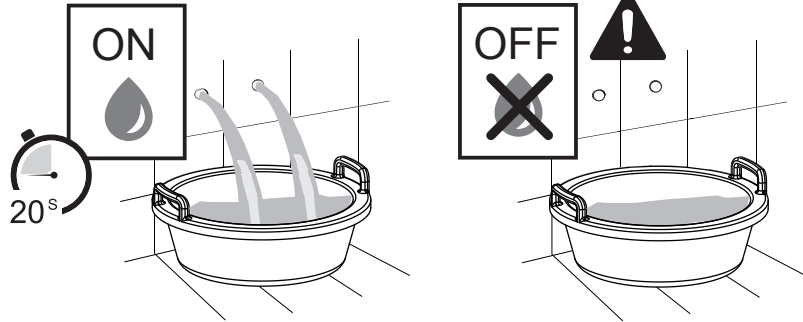

2

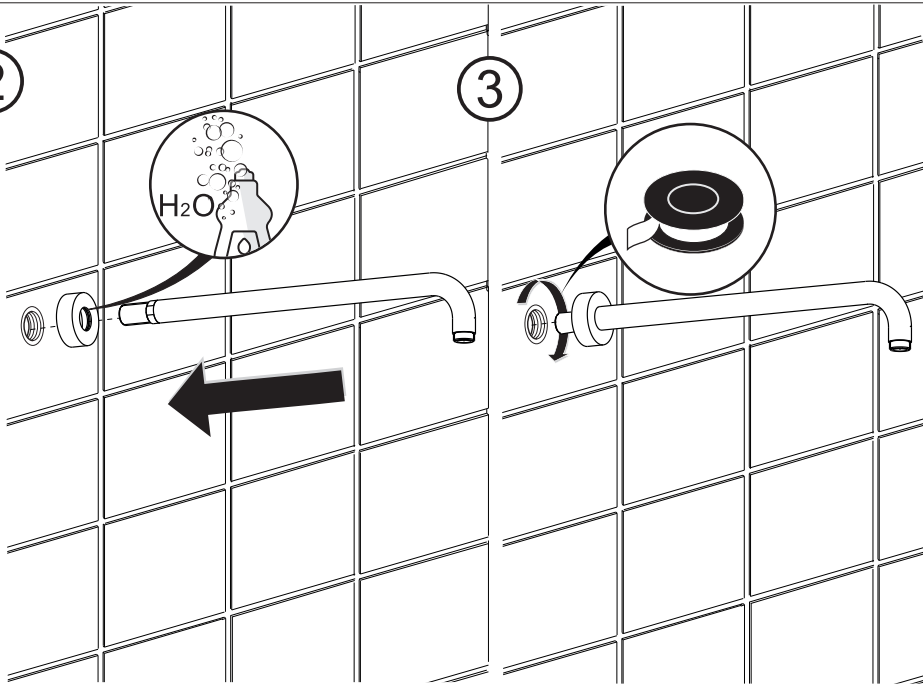

3

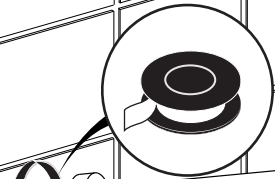

4

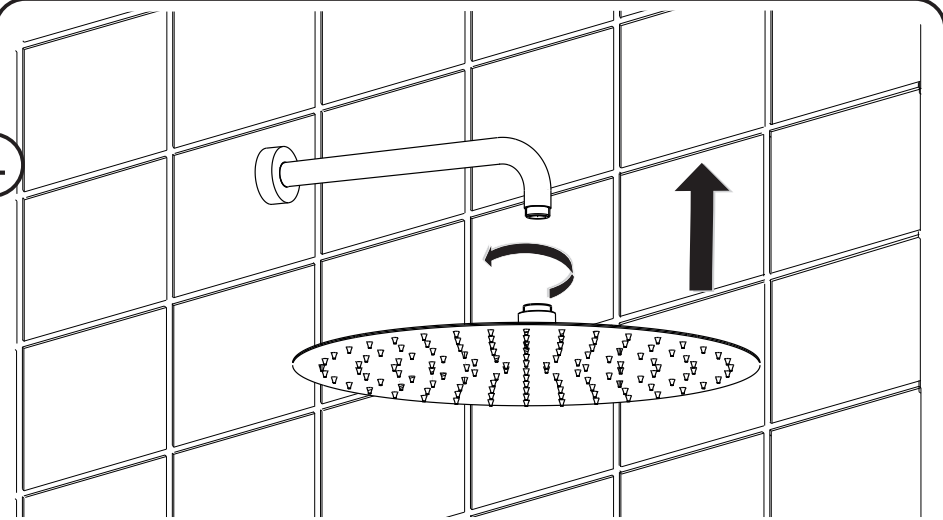

A

Pulizia degli ugelli/ How to clean the nozzles /Comment nettoyer les buses/ Reinigung der Noppen /Como limpiar las boquillas

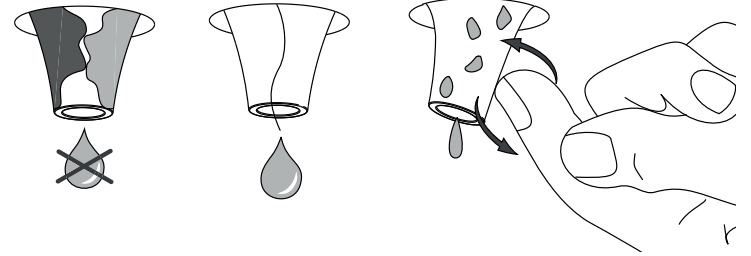

B

