





Model Code: BS2CO

Included Accessories

		
ICP8	6020/OFLOW3-CO	WKC-CO

Optional Accessories

Dimensions

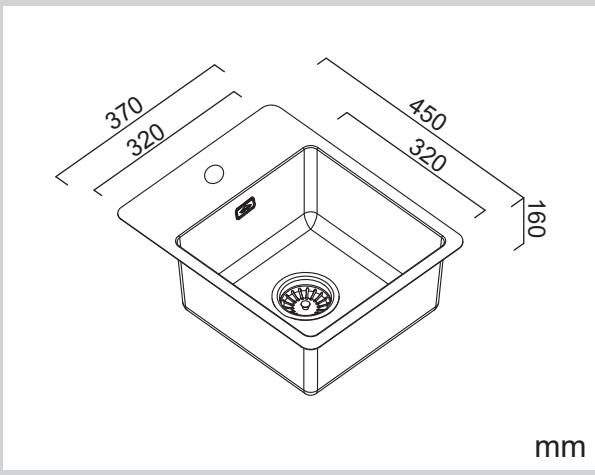

Specifications

Description	Single bowl, Inset Sink
Overall Sink Size	370mm x 450mm x 160mm deep
Bowl Dimensions	320mm x 320mm x 160mm deep
Drainer Length	N/A
Technic	Press
Material	Stainless steel SUS304

Installation

Fixings	Inset clips supplied
Template	N/A
Min Cabinet Size	450mm
Waste Holes	1 x 90mm square Compatible with waste disposal
Sealing Strip	N/A

Plumbing

Waste Fittings	1 x (90mm x 2") basket waste included
Overflow	Rectangular Overflow

Packaging

Carton Type	EPS protection & Carton
Gross Weight	3.27Kg
Carton Size	440mm x 263mm x 513mm
Pack QTY	1

SURFACE FINISH



WASTE KIT

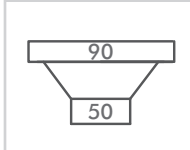

MATERIAL



INSTALLATION OPTIONS

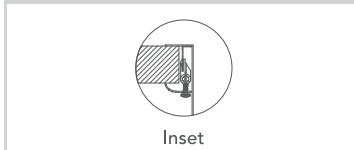

PROFILE

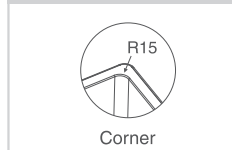

Abey are Australia's leaders in sinkware, designing and manufacturing to the world's highest quality specifications as well as sourcing and bringing you Europe's very best, leading edge designs – practical, affordable, inspirational, stylish, timeless or cutting edge. When you buy an Abey stainless steel sink you receive the highest quality and 25 year warranty. Abey and the manufacturer are continually seeking ways to improve the design specifications, aesthetic and production techniques of the products. As a result, alterations to the specifications and dimensions of the products and designs occur continually.