

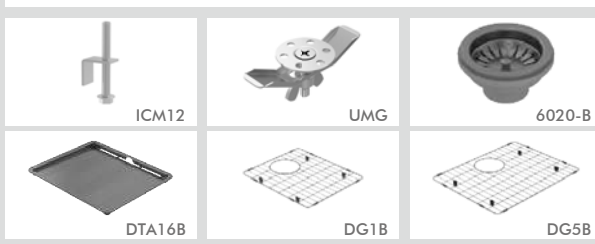

Model Code: CR500DB

Included Accessories



Optional Accessories



Dimensions

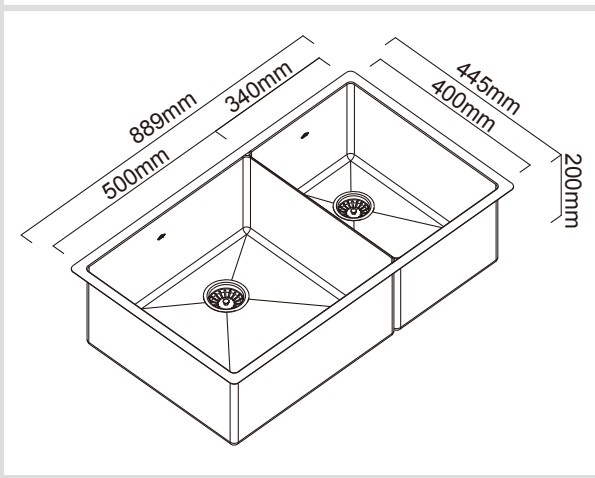

Specifications

Description	Double Bowl, Inset/Undermount Sink
Overall Sink Size	889mm x 445mm x 200mm deep
Bowl Dimensions	500mm x 400mm x 200mm deep 340mm x 400mm x 200mm deep
Drainer Length	N/A
Technic	Fabrication
Material	Stainless steel SUS304

Installation

Fixings	Inset & Undermount clips supplied
Template	N/A
Min Cabinet Size	900mm
Waste Holes	2 x 90mm round Compatible with waste disposal

Plumbing

Waste Fittings	2 x (90mm x 2") basket wastes included
Overflow	Available, conditions apply

Packaging

Carton Type	EPS protection & individual carton
Gross Weight	14.5Kg
Carton Size	965mm x 286mm x 513mm
Pack QTY	1

SURFACE FINISH



WASTE KIT

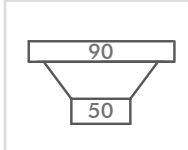

MATERIAL



INSTALLATION OPTIONS

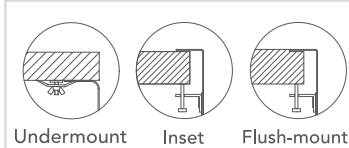

PROFILE



Abey are Australia's leaders in sinkware, designing and manufacturing to the world's highest quality specifications as well as sourcing and bringing you Europe's very best, leading edge designs – practical, affordable, inspirational, stylish, timeless or cutting edge. When you buy an Abey stainless steel sink you receive the highest quality and 25 year warranty. Abey and the manufacturer are continually seeking ways to improve the design specifications, aesthetic and production techniques of the products. As a result, alterations to the specifications and dimensions of the products and designs occur continually.