





Model Code: EC200L

Included

		
ICP12	6020	

Optional Accessories

		
DR006	AQCB	ADT1

Dimensions

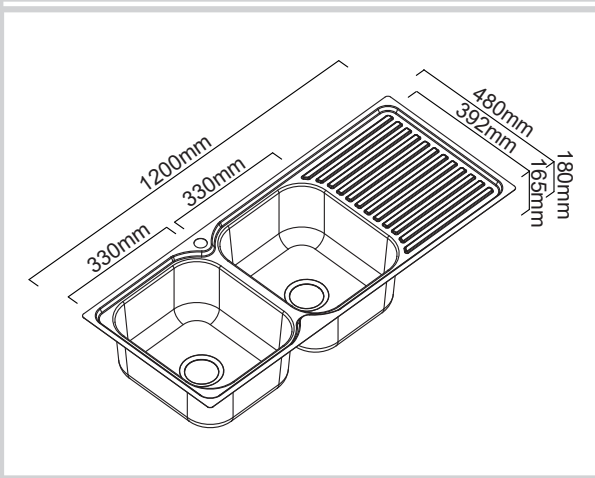

Specifications

Description	Double bowls with one Drainer, Inset sink
Overall Sink Size	1200mm x 480mm x 180mm deep
Bowl Dimensions	330mm x 392mm x 168mm deep 330mm x 392mm x 168mm deep
Drainer Length	468mm
Technic	Pressed
Material	Stainless steel SUS304

Installation

Fixings	Inset clips supplied
Template	Supplied
Min Cabinet Size	800mm
Waste Holes	2x 90mm round Compatible with waste disposal

Plumbing

Waste Fittings	2 x (90mm x 2") basket waste included
Overflow	No

Packaging

Carton Type	EPS protection & individual sleeve
Gross Weight	6.4Kg
Carton Size	1240mm x 520mm x 55mm
Pack QTY	1

SURFACE FINISH

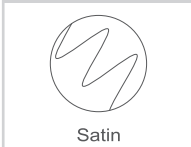

WASTE KIT

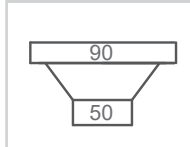

MATERIAL



INSTALLATION OPTIONS

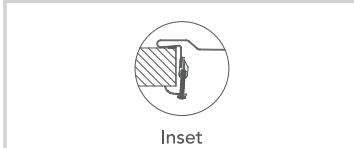

PROFILE

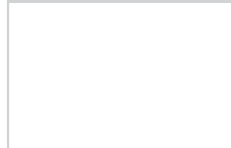

Abey are Australia's leaders in sinkware, designing and manufacturing to the world's highest quality specifications as well as sourcing and bringing you Europe's very best, leading edge designs – practical, affordable, inspirational, stylish, timeless or cutting edge. When you buy an Abey stainless steel sink you receive the highest quality and a 25 year warranty. Abey and the manufacturer are continually seeking ways to improve the design specifications, aesthetic and production techniques of the products. As a result, alterations to the specifications and dimensions of the products and designs occur continually.