





Model Code: RFA200K

Included Accessories

 ICE10	 LB-9134	 CBB282
 DTA30		

Optional Accessories

 UMD	 DR006	 6020

Dimensions

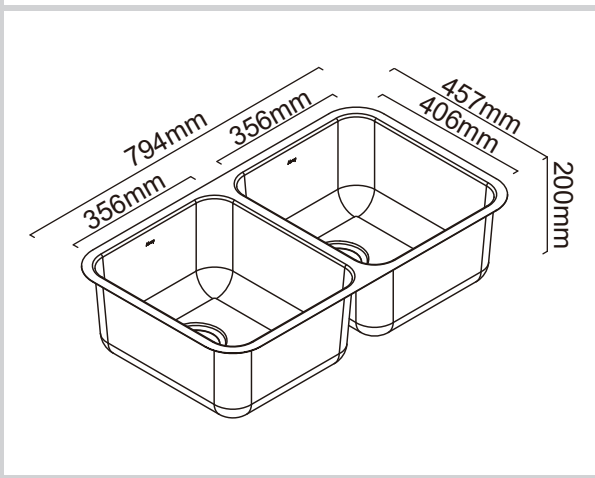

Specifications

Description	Double Bowl
Overall Sink Size	794mm x 457mm x 200mm deep
Bowl Dimensions	356mm x 406mm x 200mm deep 356mm x 406mm x 200mm deep
Drainer Length	N/A
Technic	Pressed
Material	1.1mm Stainless steel SUS304

Installation

Fixings	Inset clips supplied
Template	N/A
Min Cabinet Size	900mm
Waste Holes	2 x 90mm round Compatible with waste disposal

Plumbing

Waste Fittings	2 x (90mm x 2") basket waste included
----------------	---------------------------------------

Packaging

Carton Type	EPS protection & individual sleeve
Gross Weight	12Kg
Carton Size	835mm x 330mm x 500mm
Pack QTY	1

SURFACE FINISH

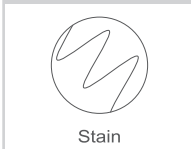

WASTE KIT

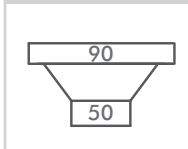

MATERIAL



INSTALLATION OPTIONS

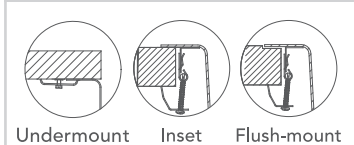

PROFILE

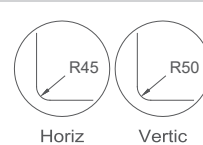

Abey are Australia's leaders in sinkware, designing and manufacturing to the world's highest quality specifications as well as sourcing and bringing you Europe's very best, leading edge designs – practical, affordable, inspirational, stylish, timeless or cutting edge. When you buy an Abey stainless steel sink you receive the highest quality and a 25 year warranty. Abey and the manufacturer are continually seeking ways to improve the design specifications, aesthetic and production techniques of the products. As a result, alterations to the specifications and dimensions of the products and designs occur continually.