

**⚠ CAUTION** Light Fitting Must Be Installed By A Licensed Electrician

Please ensure to read instructions correctly for the installation of the fitting provided. Failure to do so will result in a void of warranty and compromises the safety of luminaire.

FAZE are not liable for warranties when luminaire is damaged by incorrect installation. The installation of the luminaires must be in accordance with the national safety regulations.

Please refer to FAZE's General Terms & Conditions for more information concerning the installation and warranty of our products.

**Handle With Care**

Please ensure the Flow Side is not modified or converted than otherwise prescribed.

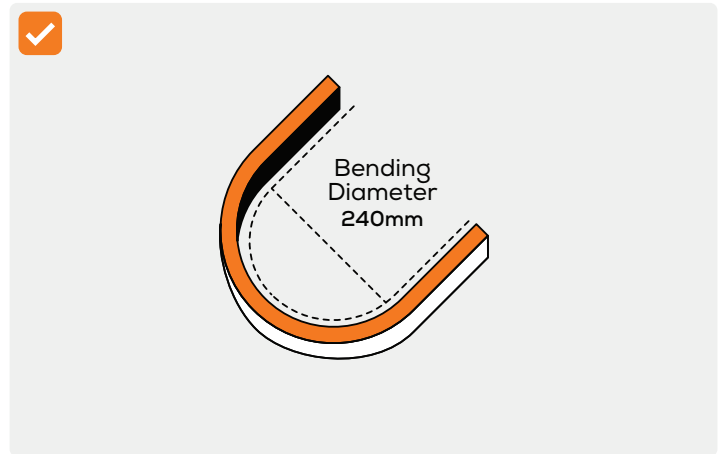
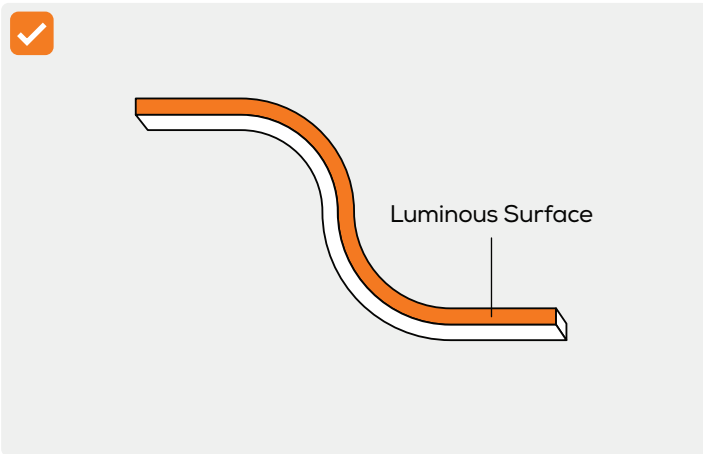

**Only Bend To The Left or Right**

Please ensure the Flow Side is only bent to the left or right, as shown in the diagram above. Make sure this pre-determined bending direction is never changed.

**Do Not Exceed Maximum Bending Diameter**

Please ensure the Flow Side does not bend tighter than the maximum bending diameter of 240mm.

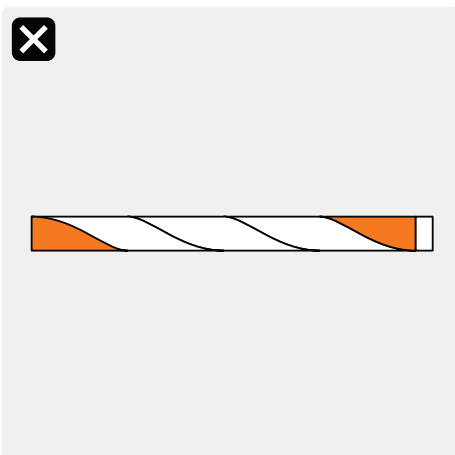

**Do Not Twist**



**Do Not Let It Hang**

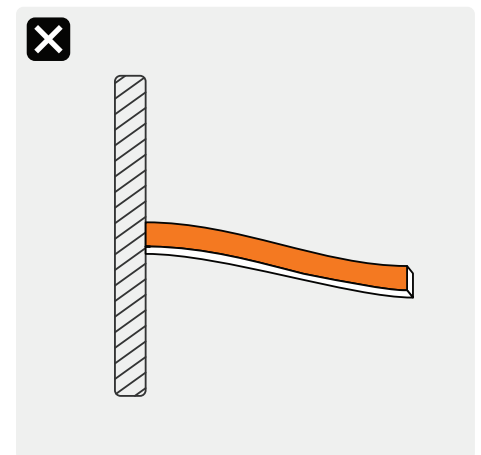

**Do Not Let It Sag**

LED	5W / 10W	Warranty	5 Years	CRI	90+
Category	LED Strip	Material	Extruded Silicone	IP Rating	67



For warranty information please visit [fazelight.com](http://fazelight.com)  
For all other queries, please call us on 1300 438 609

### What You Need Per Meter For Installation

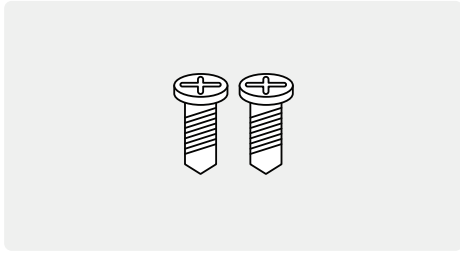

2x Screws

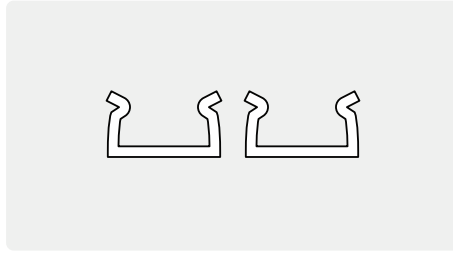

2x Mounting Clips

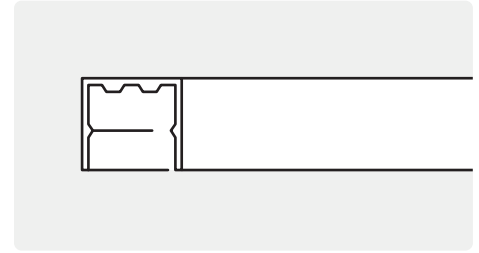

Aluminium Profile

### Installation Instructions

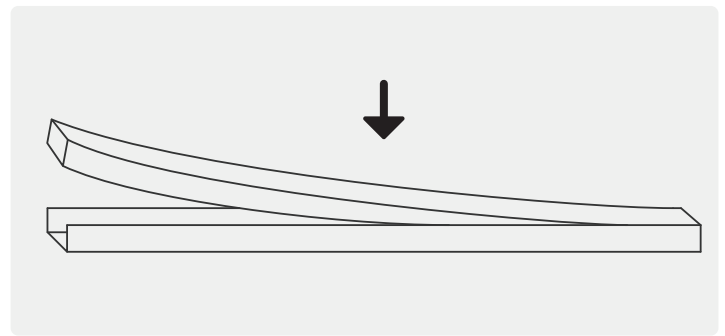
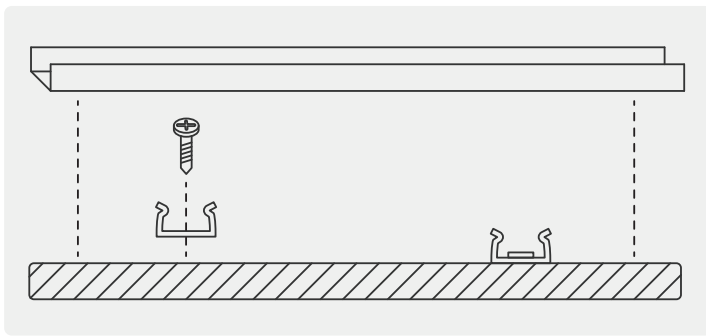

Press gently with palm of hand along the length of the strip. Do not use fingers to press in.

### Entry Connections

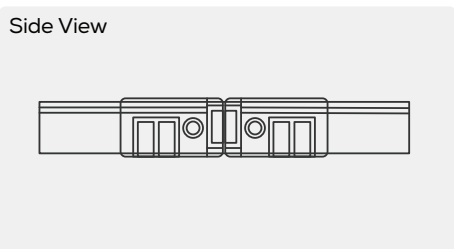
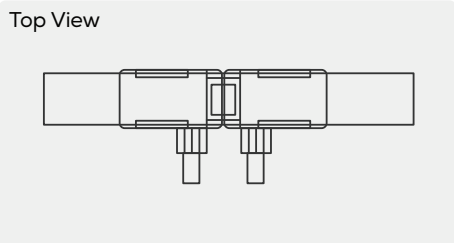

Side Cable Entry  
Seamless Connection

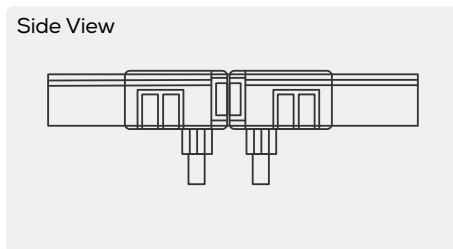
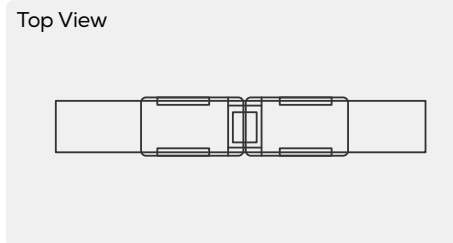

Bottom Cable Entry  
Seamless Connection

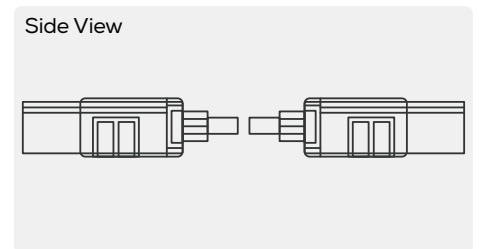
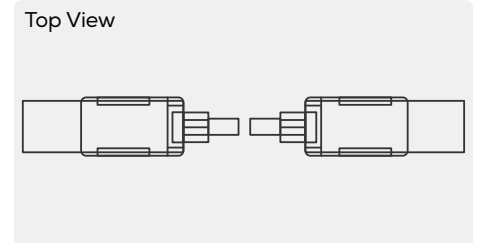

Front Cable Entry