

Legend

- Design
- Cadastre

Map: 2135645A_GIS_1537_A2

Author: MB



Date: 23/11/2018

Approved by: -



1:2,000

Coordinate system: GDA 1994 MGA Zone 55

Scale ratio correct when printed at A3

Data source: Copyright © The State of Victoria, Department of Environment, Land, Water & Planning 2018
ID: 2135645A-N-17-GIS-MAP-0001-B



PRELIMINARY

**Engineering and Technical Services
for Craigieburn Road West Upgrade**

Preliminary design
Map 1

© WSP | Parsons Brinckerhoff - Asia Pacific (WSP | PB) Copyright in the drawings, information and data recorded is the property of WSP | PB. This document and the information are solely for the use of the authorised recipient and this document may not be used, copied or reproduced in whole or part for any purpose other than that which it was supplied by WSP | PB. WSP | PB makes no representation, undertakes no duty and accepts no responsibility to any third party who may use or rely upon this document or the information. NCSI Certified Quality System to ISO 9001. © APPROVED FOR AND ON BEHALF OF WSP | Parsons Brinckerhoff - Asia Pacific.

\\Agmeff01\proj\VicRoads\2135645A_OSAR_ENGINEERING_TECHNICAL_SE10_GIS\Projects\Maps\2135645A_GIS_1537_A2.mxd

MRPA

www.wsp.com

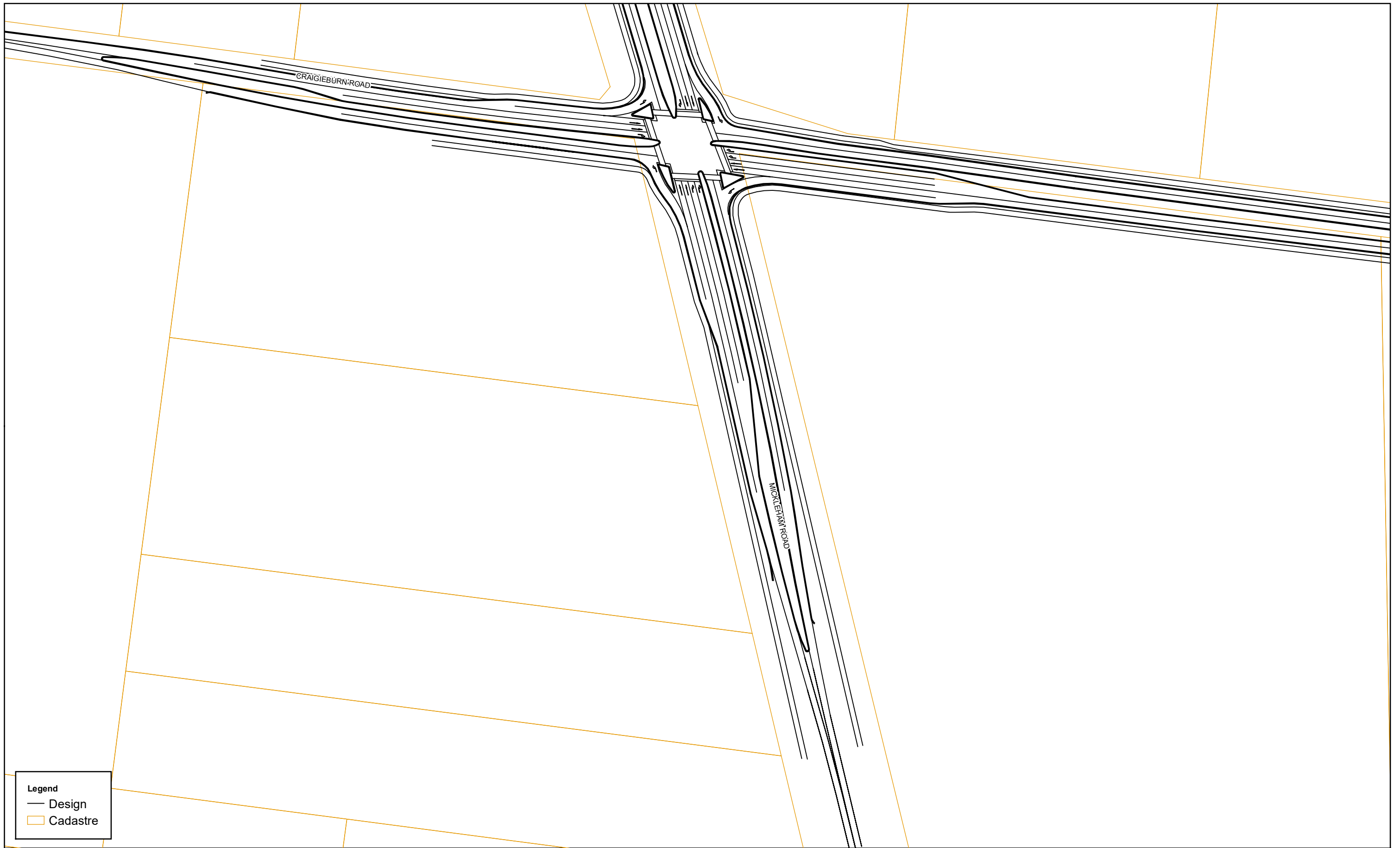

Legend

- Design
- ▭ Cadastre

Map: 2135645A_GIS_1537_A2

Author: MB



Date: 23/11/2018

Approved by: -

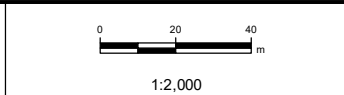

1:2,000
Coordinate system: GDA 1994 MGA Zone 55
Scale ratio correct when printed at A3



**Engineering and Technical Services
for Craigieburn Road West Upgrade**

Preliminary design
Map 2

© WSP | Parsons Brinckerhoff - Asia Pacific (WSP | PB) Copyright in the drawings, information and data recorded is the property of WSP | PB. This document and the information are solely for the use of the authorised recipient and this document may not be used, copied or reproduced in whole or part for any purpose other than that which it was supplied by WSP | PB. WSP | PB makes no representation, undertakes no duty and accepts no responsibility to any third party who may use or rely upon this document or the information. NCSI Certified Quality System to ISO 9001. © APPROVED FOR AND ON BEHALF OF WSP | Parsons Brinckerhoff - Asia Pacific.

\\Agmeff01\proj\VicRoads\2135645A_OSAR_ENGINEERING_TECHNICAL_SE10_GIS\Projects\Maps\2135645A_GIS_1537_A2.mxd

MRPA

www.wsp.com

PRELIMINARY

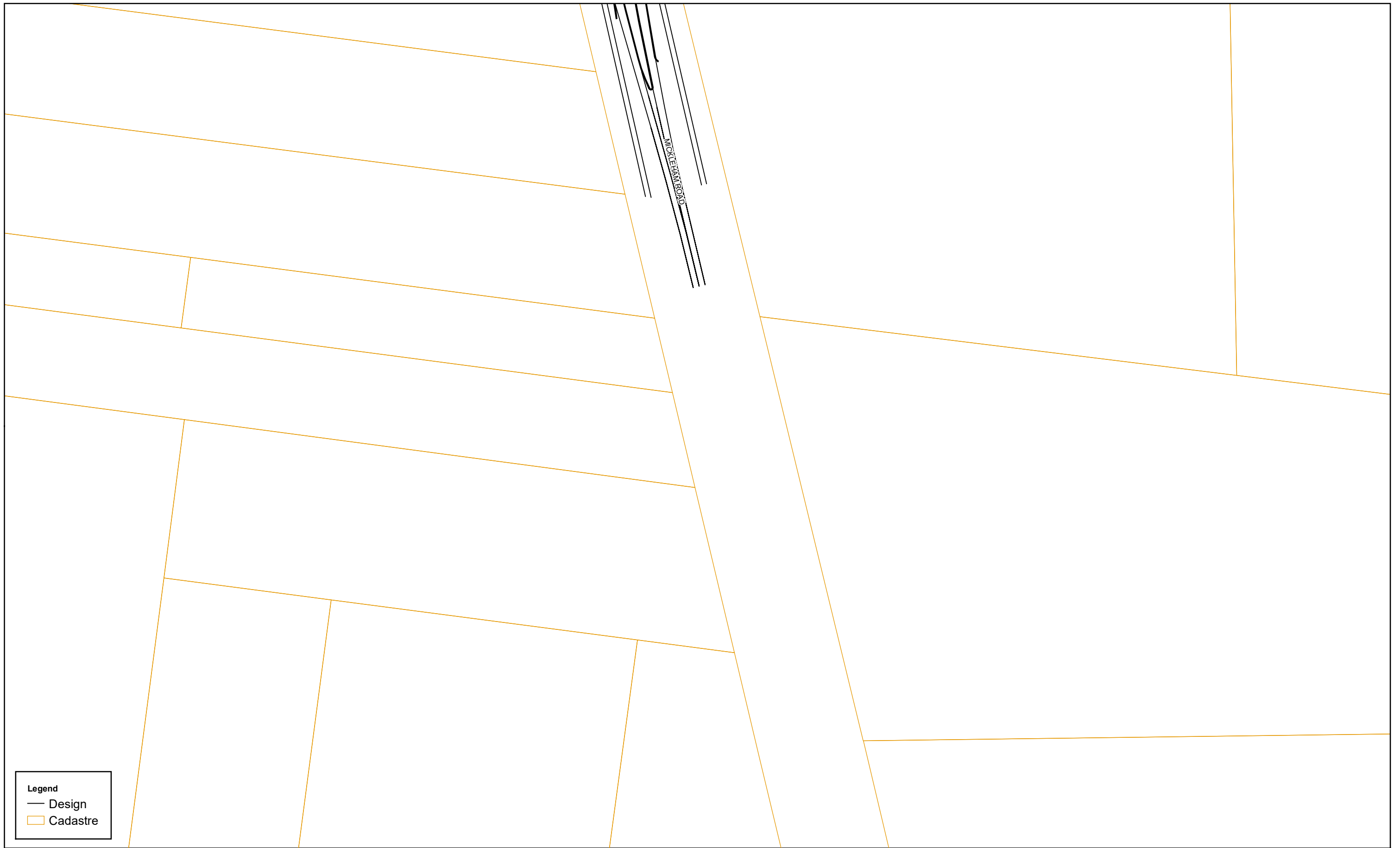

Legend

- Design
- ▭ Cadastre

Map: 2135645A_GIS_1537_A2	Author: MB		 1:2,000 Coordinate system: GDA 1994 MGA Zone 55 Scale ratio correct when printed at A3	 	Engineering and Technical Services for Craigieburn Road West Upgrade
Date: 23/11/2018	Approved by: -				
Data source: Copyright © The State of Victoria, Department of Environment, Land, Water & Planning 2018 ID: 2135645A-N-17-GIS-MAP-0001-B					
© WSP Parsons Brinckerhoff - Asia Pacific (WSP PB) Copyright in the drawings, information and data recorded is the property of WSP PB. This document and the information are solely for the use of the authorised recipient and this document may not be used, copied or reproduced in whole or part for any purpose other than that which it was supplied by WSP PB. WSP PB makes no representation, undertakes no duty and accepts no responsibility to any third party who may use or rely upon this document or the information. NCSI Certified Quality System to ISO 9001. © APPROVED FOR AND ON BEHALF OF WSP Parsons Brinckerhoff - Asia Pacific.					
\\Agmeff01\proj\VicRoads\2135645A_OSAR_ENGINEERING_TECHNICAL_SE10_GIS\Projects\Maps\2135645A_GIS_1537_A2.mxd				MRPA	www.wsp.com

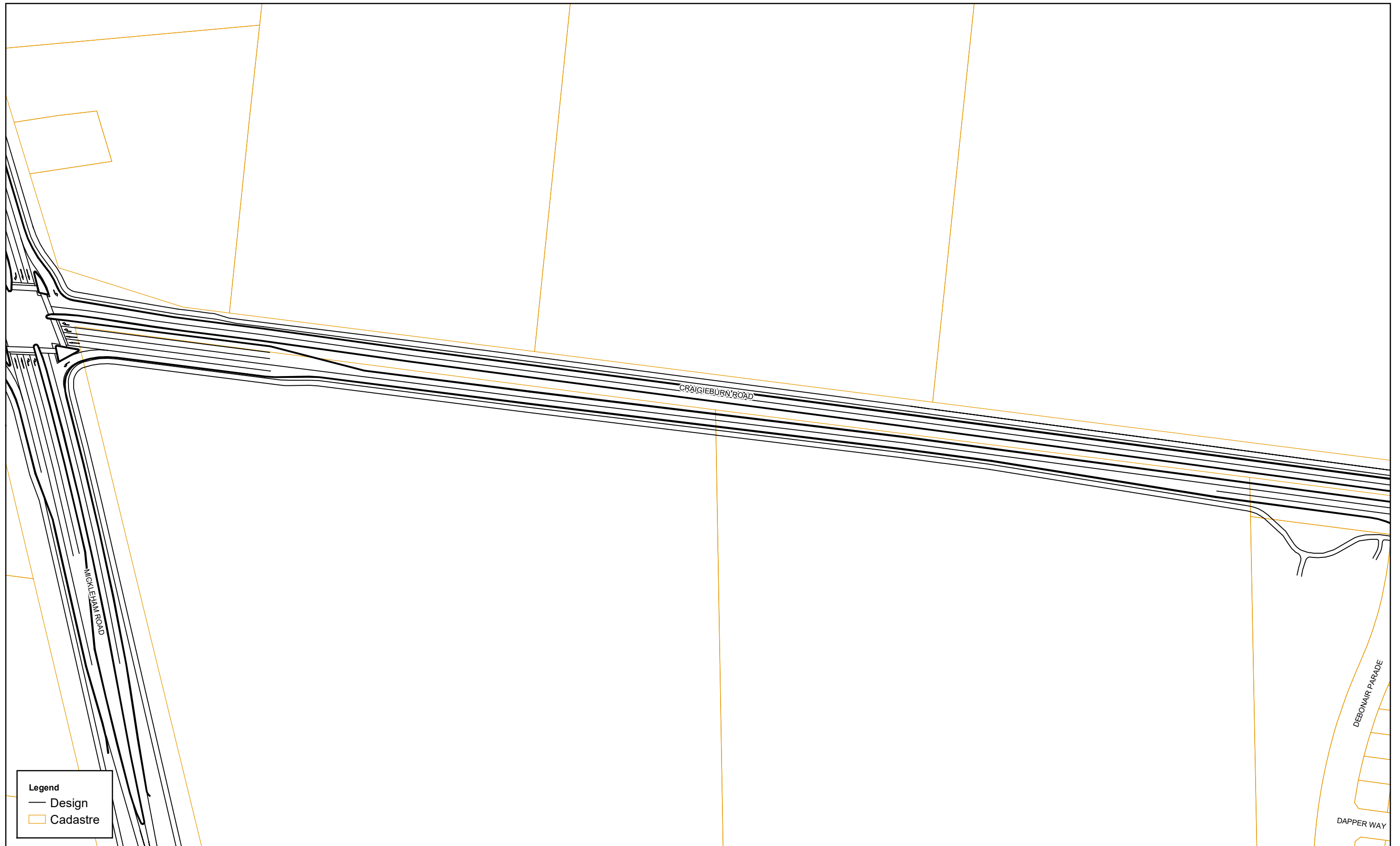

Legend
 — Design
 □ Cadastral

Map: 2135645A_GIS_1537_A2 Author: MB

Date: 23/11/2018 Approved by: -

Data source: Copyright © The State of Victoria, Department of Environment, Land, Water & Planning 2018
 ID: 2135645A-N-17-GIS-MAP-0001-B

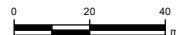
1:2,000
 Coordinate system: GDA 1994 MGA Zone 55
 Scale ratio correct when printed at A3





PRELIMINARY

**Engineering and Technical Services
 for Craigieburn Road West Upgrade**

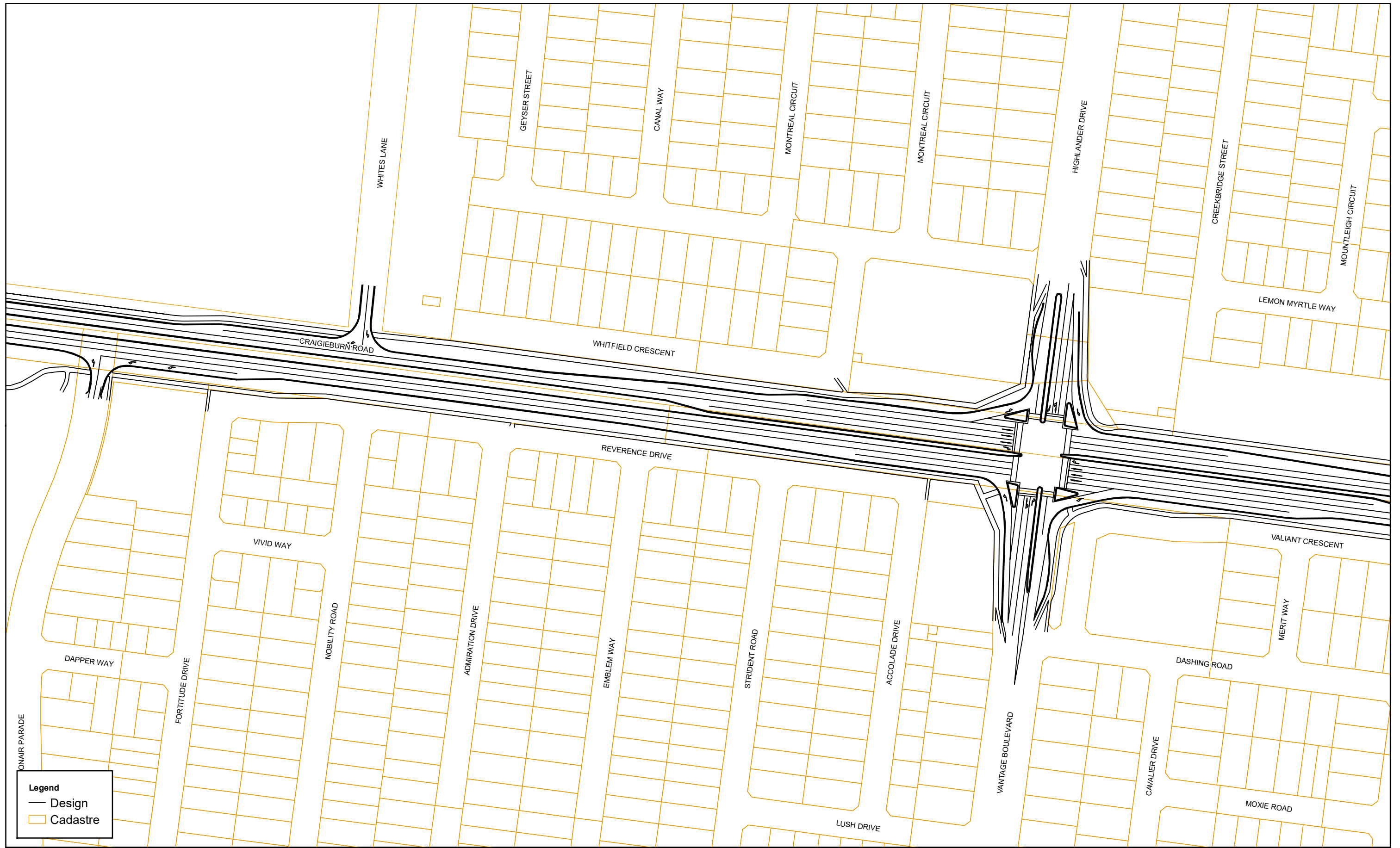

Preliminary design
 Map 4

© WSP | Parsons Brinckerhoff - Asia Pacific (WSP | PB) Copyright in the drawings, information and data recorded is the property of WSP | PB. This document and the information are solely for the use of the authorised recipient and this document may not be used, copied or reproduced in whole or part for any purpose other than that which it was supplied by WSP | PB. WSP | PB makes no representation, undertakes no duty and accepts no responsibility to any third party who may use or rely upon this document or the information. NCSI Certified Quality System to ISO 9001. © APPROVED FOR AND ON BEHALF OF WSP | Parsons Brinckerhoff - Asia Pacific.



Legend

- Design
- ▭ Cadastre

Map: 2135645A_GIS_1537_A2	Author: MB		 1:2,000 Coordinate system: GDA 1994 MGA Zone 55 Scale ratio correct when printed at A3
Date: 23/11/2018	Approved by: -		
<small>Data source: Copyright © The State of Victoria, Department of Environment, Land, Water & Planning 2018 ID: 2135645A-N-17-GIS-MAP-0001-B</small>			



PRELIMINARY

MRPA

**Engineering and Technical Services
for Craigieburn Road West Upgrade**

Preliminary design
Map 5

www.wsp.com

Agreement: \\proj\vicroads\2135645A_OSAR_ENGINEERING_TECHNICAL_SE10_GIS\Projects\Maps\2135645A_GIS_1537_A2.mxd

© WSP | Parsons Brinckerhoff - Asia Pacific (WSP | PB) Copyright in the drawings, information and data recorded is the property of WSP | PB. This document and the information are solely for the use of the authorised recipient and this document may not be used, copied or reproduced in whole or part for any purpose other than that which it was supplied by WSP | PB. WSP | PB makes no representation, undertakes no duty and accepts no responsibility to any third party who may use or rely upon this document or the information. NCSI Certified Quality System to ISO 9001. © APPROVED FOR AND ON BEHALF OF WSP | Parsons Brinckerhoff - Asia Pacific.

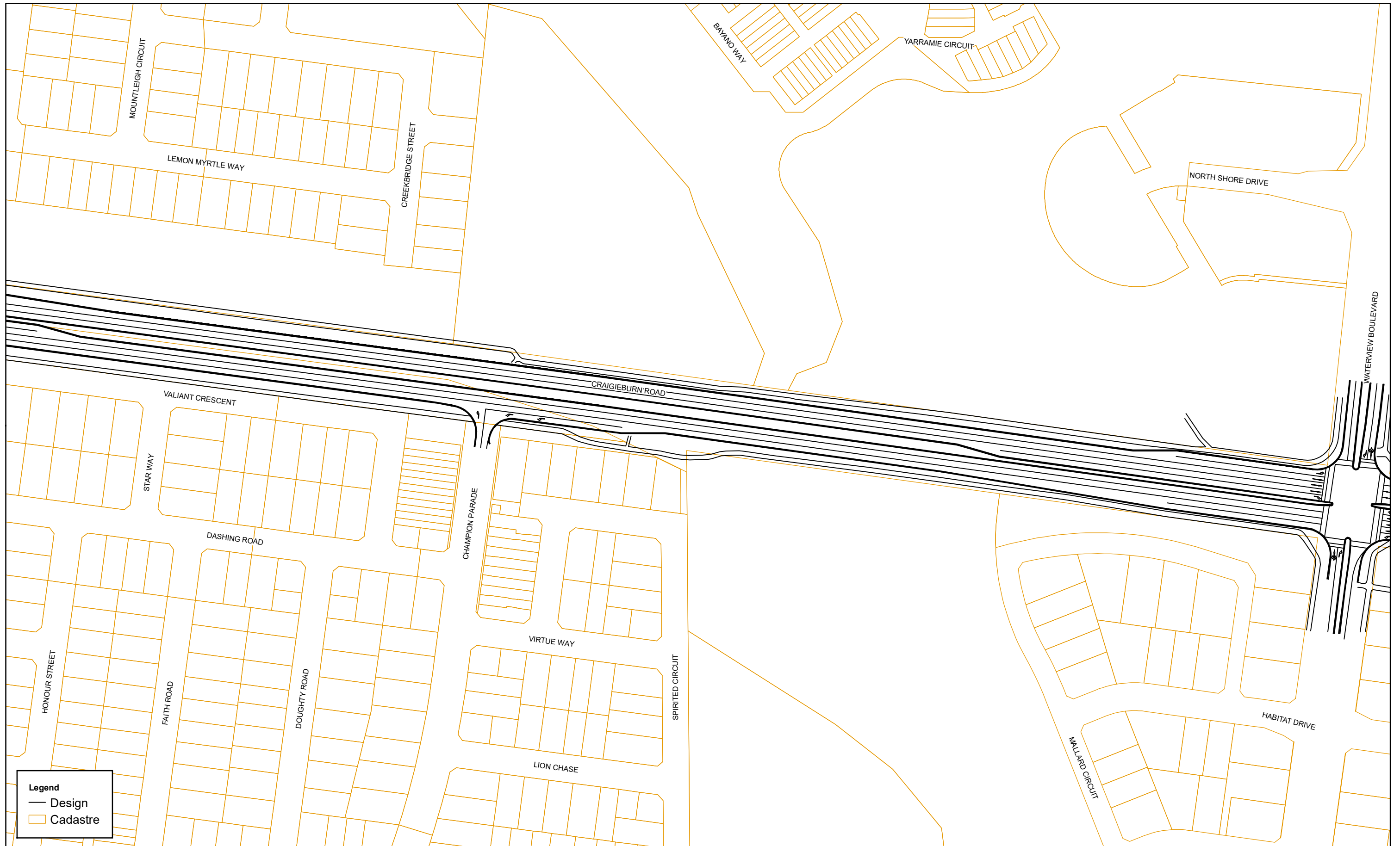

Legend

- Design
- Cadastre

Map: 2135645A_GIS_1537_A2
 Author: MB
 Date: 23/11/2018
 Approved by: -

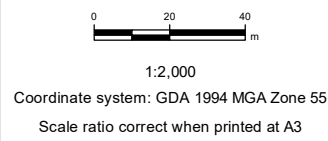

**Engineering and Technical Services
 for Craigieburn Road West Upgrade**

Data source: Copyright © The State of Victoria, Department of Environment, Land, Water & Planning 2018
 ID: 2135645A-N-17-GIS-MAP-0001-B

© WSP | Parsons Brinckerhoff - Asia Pacific (WSP | PB) Copyright in the drawings, information and data recorded is the property of WSP | PB. This document and the information are solely for the use of the authorised recipient and this document may not be used, copied or reproduced in whole or part for any purpose other than that which it was supplied by WSP | PB. WSP | PB makes no representation, undertakes no duty and accepts no responsibility to any third party who may use or rely upon this document or the information. NCSI Certified Quality System to ISO 9001. © APPROVED FOR AND ON BEHALF OF WSP | Parsons Brinckerhoff - Asia Pacific.



PRELIMINARY

Preliminary design
 Map 6

\\pmeff01\proj\VicRoads\2135645A_OSAR_ENGINEERING_TECHNICAL_SE10_GIS\Projects\Maps\2135645A_GIS_1537_A2.mxd

MRPA

www.wsp.com

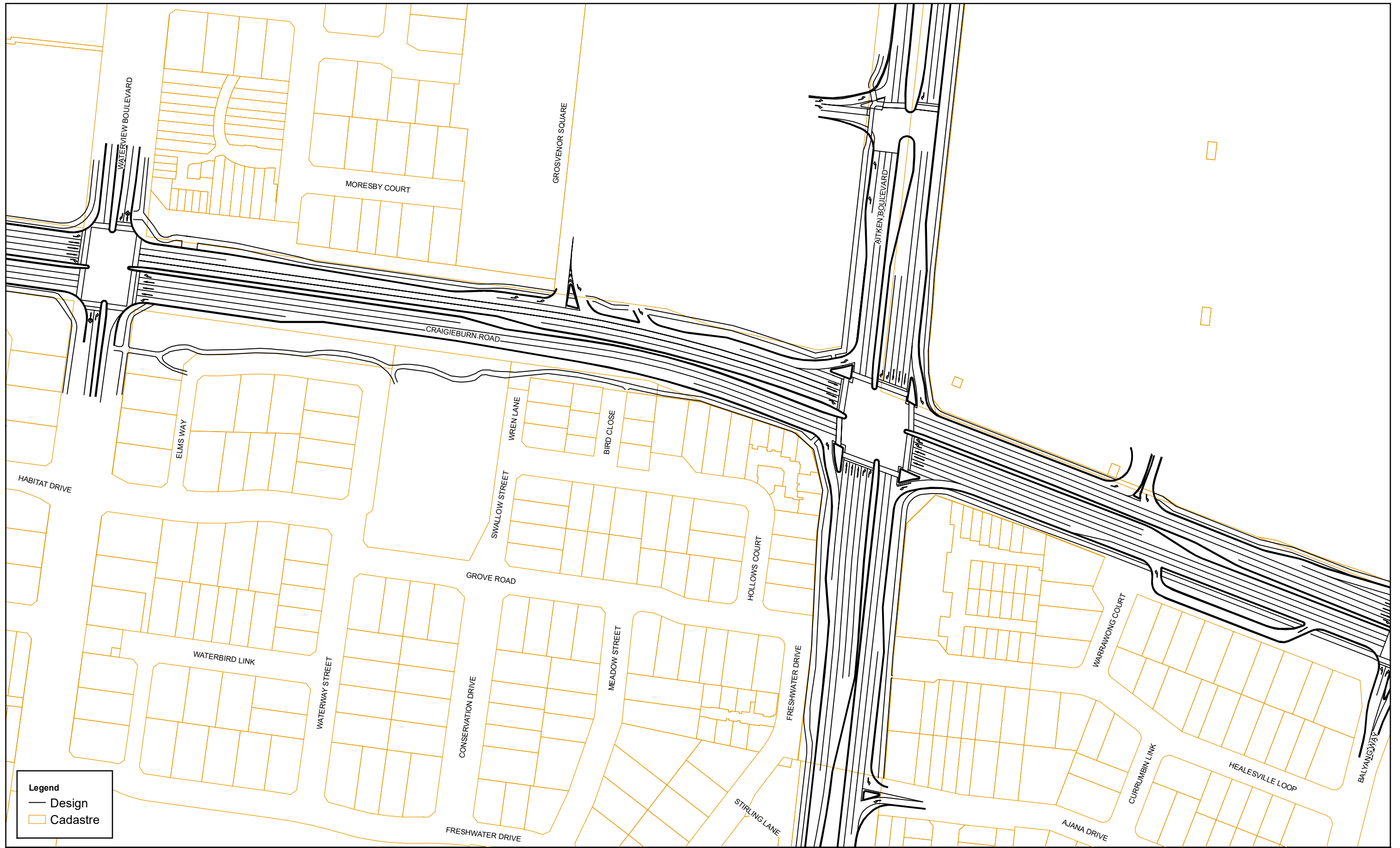

Legend

- Design
- ▭ Cadastre

Map: 2135645A_GIS_1537_A2	Author: MB
Date: 23/11/2018	Approved by: -
Data source: Copyright © The State of Victoria, Department of Environment, Land, Water & Planning 2018 ID: 2135645A-N-17-GIS-MAP-0001-B	
<small>© WSP Parsons Brinckerhoff - Asia Pacific (WSP PB) Copyright in the drawings, information and data recorded is the property of WSP PB. This document and the information are solely for the use of the authorised recipient and this document may not be used, copied or reproduced in whole or part for any purpose other than that which it was supplied by WSP PB. WSP PB makes no representation, undertakes no duty and accepts no responsibility to any third party who may use or rely upon this document or the information. NCSI Certified Quality System to ISO 9001. © APPROVED FOR AND ON BEHALF OF WSP Parsons Brinckerhoff - Asia Pacific.</small>	





 1:2,000

Coordinate system: GDA 1994 MGA Zone 55
Scale ratio correct when printed at A3



wsp

MRPA

Engineering and Technical Services
for Craigieburn Road West Upgrade

PRELIMINARY

Preliminary design
Map 7

www.wsp.com

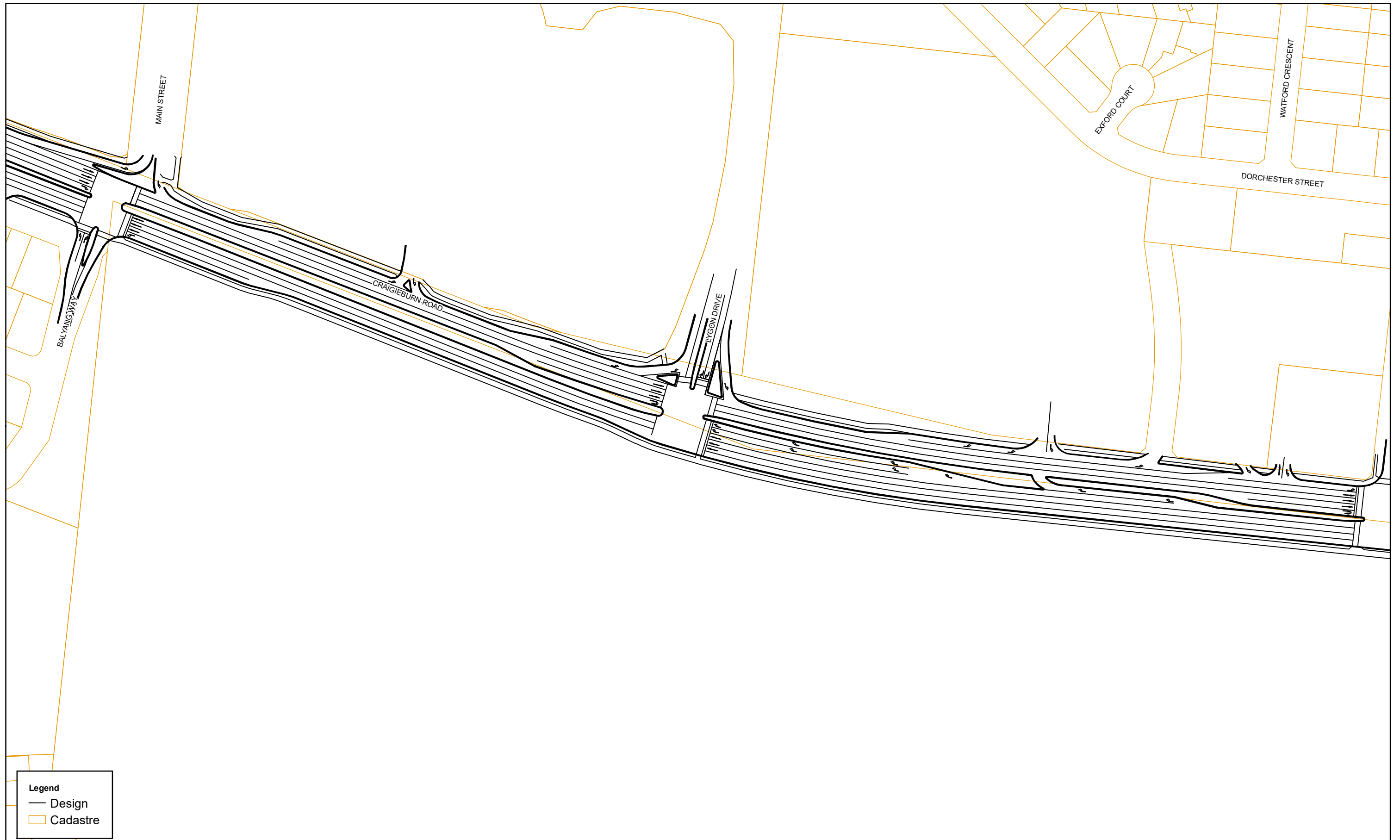

Legend

- Design
- ▭ Cadastre

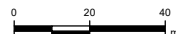
Map: 2135645A_GIS_1537_A2	Author: MB		 1:2,000 Coordinate system: GDA 1994 MGA Zone 55 Scale ratio correct when printed at A3
Date: 23/11/2018	Approved by: -		
<small>Data source: Copyright © The State of Victoria, Department of Environment, Land, Water & Planning 2018 ID: 2135645A-N-17-GIS-MAP-0001-B</small>			



PRELIMINARY

**Engineering and Technical Services
for Craigieburn Road West Upgrade**

Preliminary design
Map 8

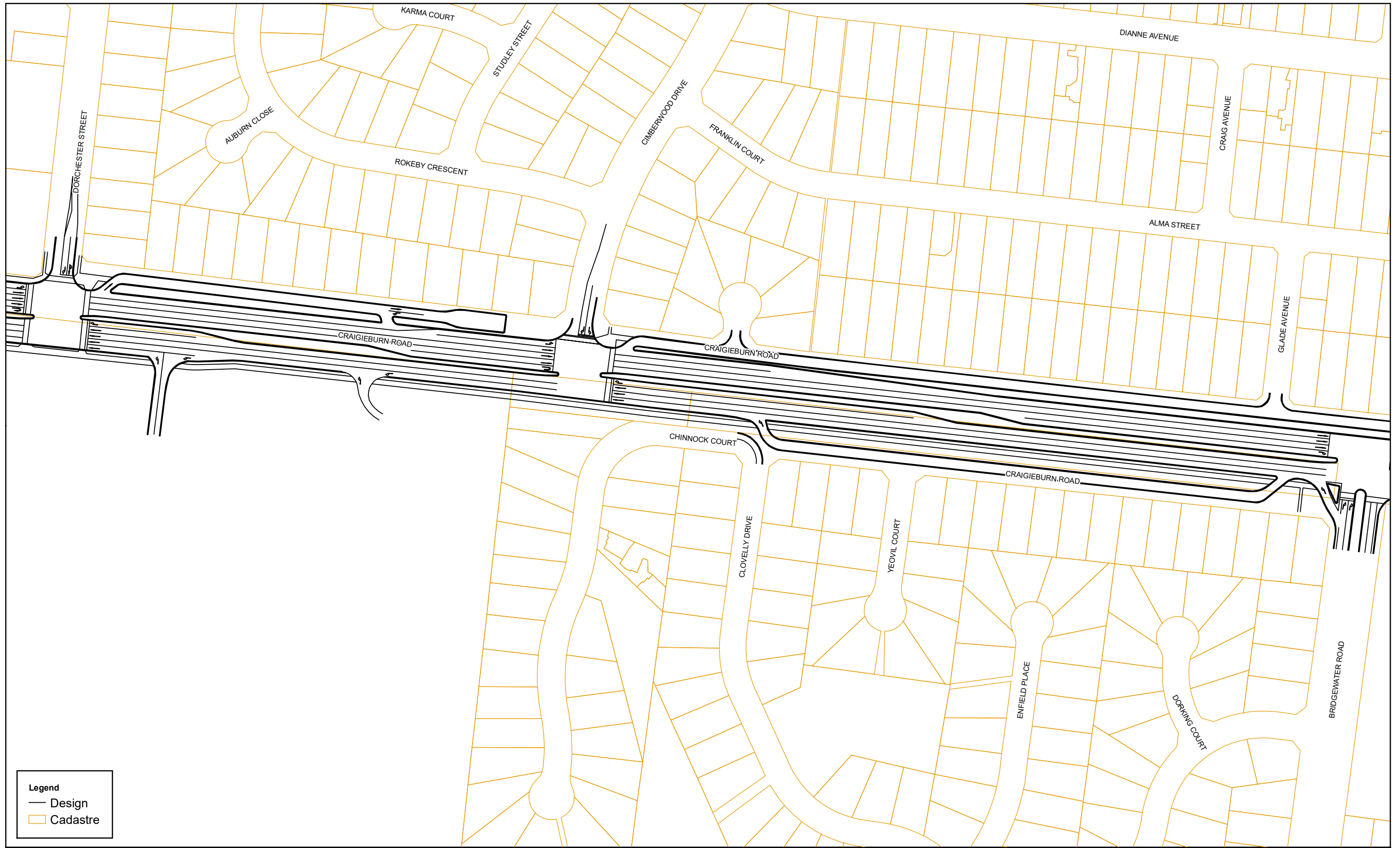

© WSP | Parsons Brinckerhoff - Asia Pacific (WSP | PB) Copyright in the drawings, information and data recorded is the property of WSP | PB. This document and the information are solely for the use of the authorised recipient and this document may not be used, copied or reproduced in whole or part for any purpose other than that which it was supplied by WSP | PB. WSP | PB makes no representation, undertakes no duty and accepts no responsibility to any third party who may use or rely upon this document or the information. NCSI Certified Quality System to ISO 9001. © APPROVED FOR AND ON BEHALF OF WSP | Parsons Brinckerhoff - Asia Pacific.



Legend

- Design
- ▭ Cadastre

Map: 2135645A_GIS_1537_A2	Author: MB
Date: 23/11/2018	Approved by: -
Data source: Copyright © The State of Victoria, Department of Environment, Land, Water & Planning 2018 ID: 2135645A-N-17-GIS-MAP-0001-B	

1:2,000
Coordinate system: GDA 1994 MGA Zone 55
Scale ratio correct when printed at A3





PRELIMINARY

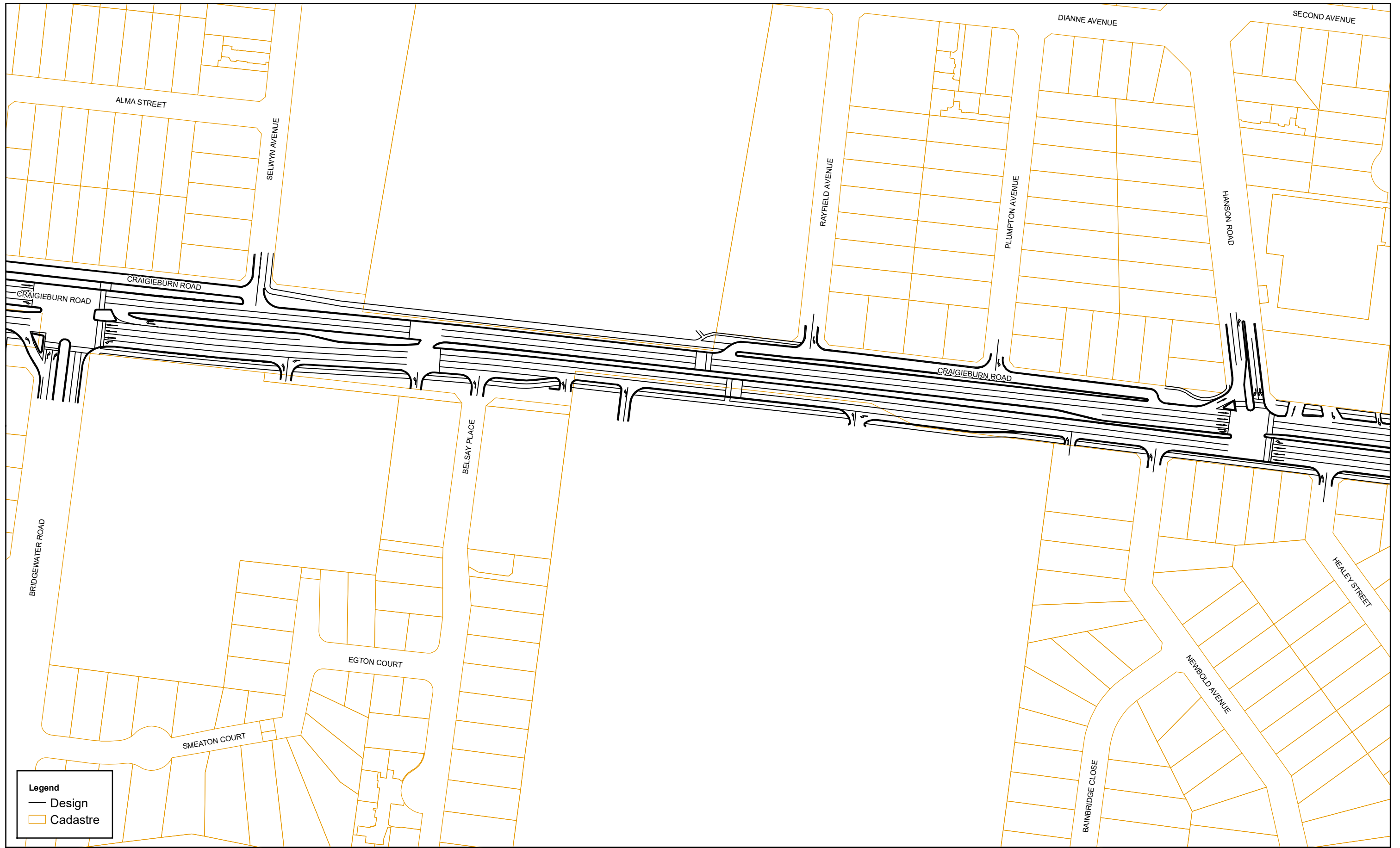

**Engineering and Technical Services
for Craigieburn Road West Upgrade**

Preliminary design
Map 9



Legend

- Design
- ▭ Cadastral

Map: 2135645A_GIS_1537_A2	Author: MB		 1:2,000
Date: 23/11/2018	Approved by: -		
<small>Data source: Copyright © The State of Victoria, Department of Environment, Land, Water & Planning 2018 ID: 2135645A-N-17-GIS-MAP-0001-B</small>		<small>Coordinate system: GDA 1994 MGA Zone 55 Scale ratio correct when printed at A3</small>	



PRELIMINARY

**Engineering and Technical Services
for Craigieburn Road West Upgrade**

Preliminary design
Map 10

© WSP | Parsons Brinckerhoff - Asia Pacific (WSP | PB) Copyright in the drawings, information and data recorded is the property of WSP | PB. This document and the information are solely for the use of the authorised recipient and this document may not be used, copied or reproduced in whole or part for any purpose other than that which it was supplied by WSP | PB. WSP | PB makes no representation, undertakes no duty and accepts no responsibility to any third party who may use or rely upon this document or the information. NCSI Certified Quality System to ISO 9001. © APPROVED FOR AND ON BEHALF OF WSP | Parsons Brinckerhoff - Asia Pacific.

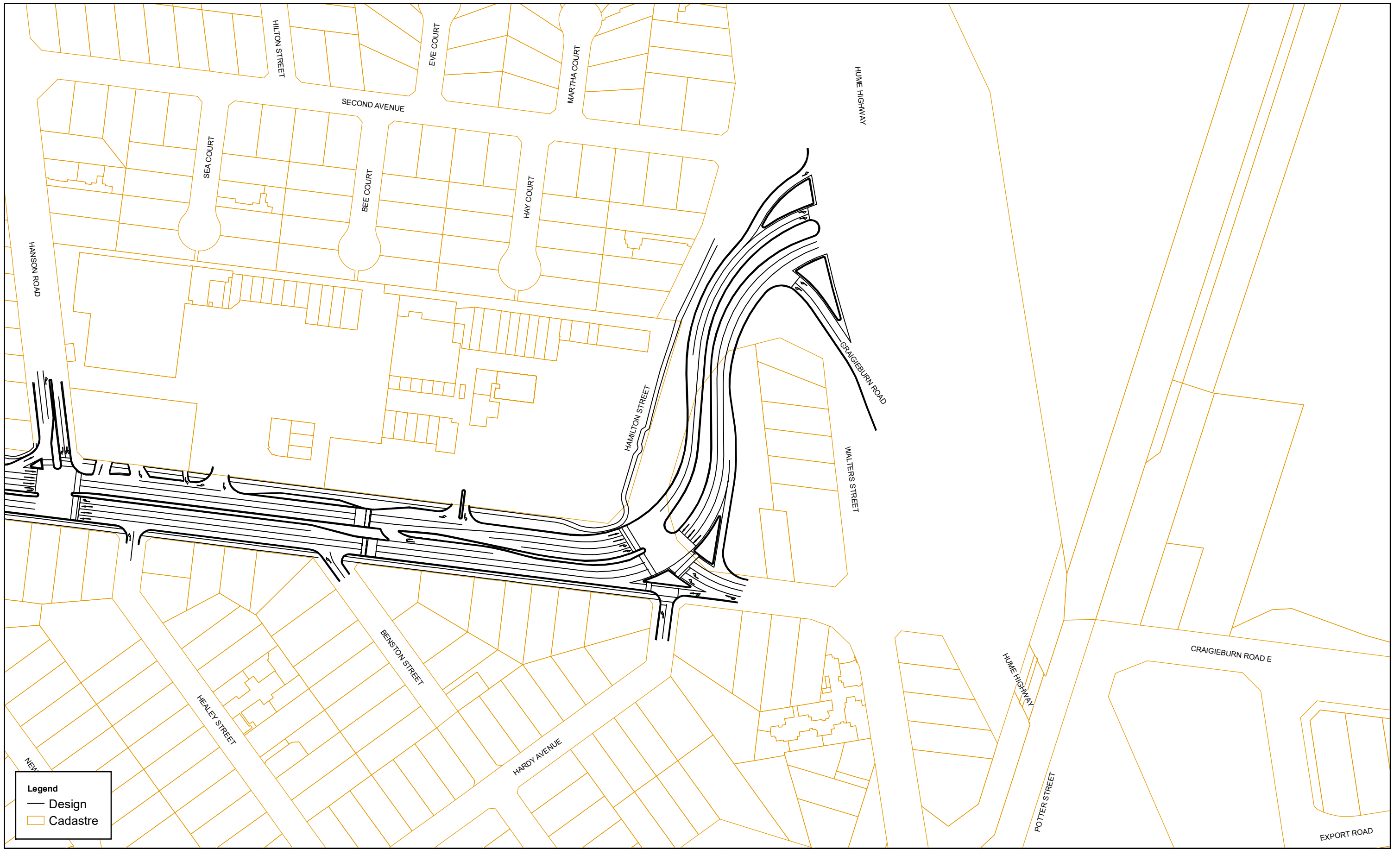



Legend

- Design
- ▭ Cadastre

Map: 2135645A_GIS_1537_A2 Author: MB

Date: 23/11/2018 Approved by: -

Data source: Copyright © The State of Victoria, Department of Environment, Land, Water & Planning 2018
ID: 2135645A-N-17-GIS-MAP-0001-B

1:2,000
Coordinate system: GDA 1994 MGA Zone 55
Scale ratio correct when printed at A3



PRELIMINARY

MRPA

**Engineering and Technical Services
for Craigieburn Road West Upgrade**

Preliminary design
Map 11

\\Agmeff01\proj\VicRoads\2135645A_OSAR_ENGINEERING_TECHNICAL_SE10_GIS\Projects\Map\2135645A_GIS_1537_A2.mxd

www.wsp.com