

LAURENT 08

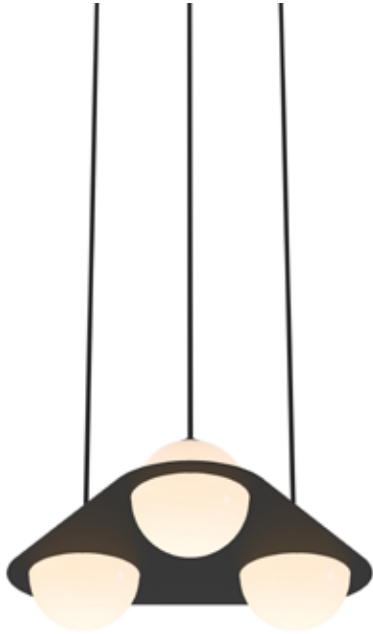

type	suspension	
materials	sphere:	handblown opaline glass
	frame:	polished brass or powder coated aluminum or nickel plated steel
	hardware:	polished brass or powder coated aluminum
	wire:	nylon/polyester
weight	14 lb / 6 kg	
light bulb	LED (included), 4,5W (see lightbulb section for specifications)	
sockets	G9	
voltage	120V / 240V	
dimmer	refer to our recommended list of dimmer models	
certifications		
notes	<ul style="list-style-type: none"> - must be installed by an electrician - additional charges for modifications or for special orders - lead time between 7-9 weeks. - dimensions are approximate and may vary slightly. 	

parallel wires

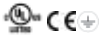
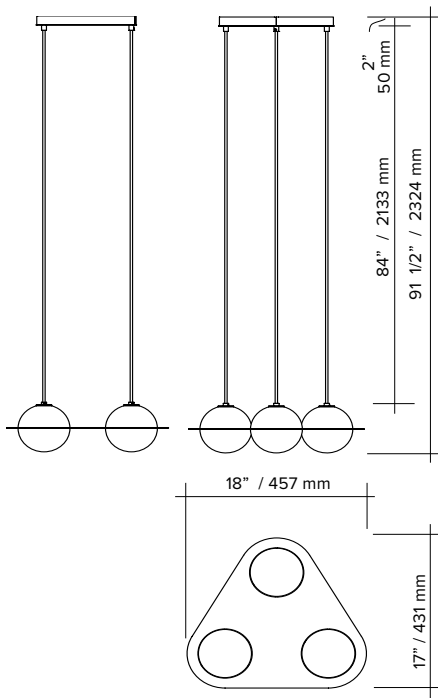

parallel wires with offset connection

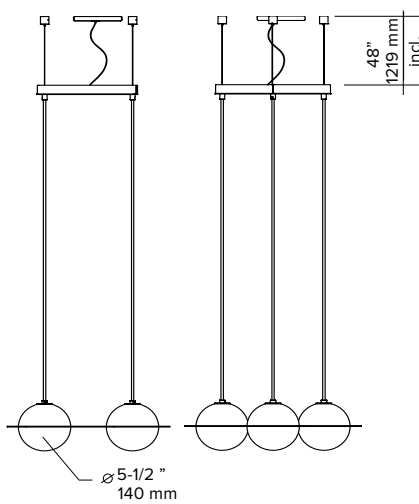

angled wires

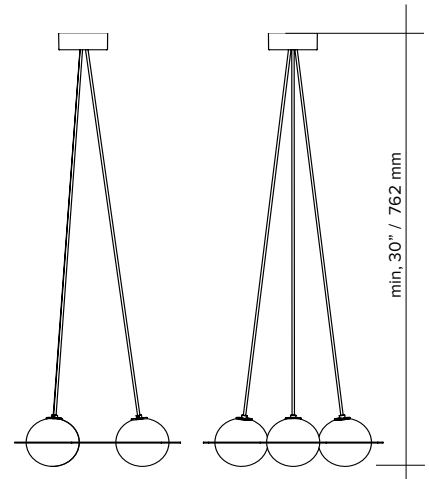

ORDER GUIDE: SKU

COLLECTION	MODEL	COLOUR (frame + wire system)	CANOPY	MOUNTING TYPE
LRT Laurent	08	BLBL black + black BRBL brass + black BRGD brass + gold CHBL chrome + black CHBE chrome + blue BEBL blue + black BEBE blue + blue BUBL burgundy + black BUSA burgundy + sand BUBU burgundy + burgundy TUBL turquoise + black TUSA turquoise + sand	BL black	AW angle wire PW parallel wire
LRT	08	BLBL	BL	AW

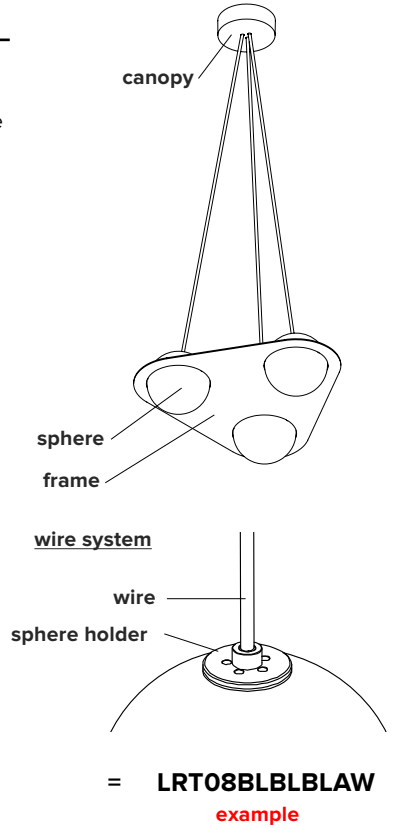

FRAME COLOUR



textured black



textured blue



textured burgundy



textured turquoise



brass



chrome

MOUNTING COLOUR sphere holder & wires



textured black



textured blue



textured burgundy



textured sand



gold



textured black



flat white

CANOPY COLOR custom color available on demand

MOUNTING TYPE



textured black

angled wires

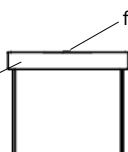

flat white (ceiling disc)

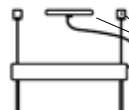

flat white

textured black

parallel wires

LIGHT BULB & DIMMER SPECIFICATIONS

G9 SOCKETS

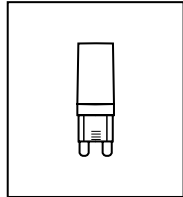

Frosted
4.5W
100V-120V / 240V
450 Lumens
2700 K
25 000 H
CRI ≥80
2 years warranty



DIMMER LIST COMPATIBILITY FOR G9 LED BULBS – 120V

The dimming technology offering the best results is ELV (electronic low voltage) dimmers with reverse phase or trailing edge control.

<u>DIMMER BRAND</u>	<u>MODEL NUMBER</u>	<u>MAX LEVEL</u>	<u>MIN LEVEL</u>	<u>FLICKERING</u>	<u>OVERALL QUOTE</u>
LUTRON - MAESTRO	MAELV-600	100%	0%	0%-10%	good
LUTRON - SKYLARK	SELV-300P	100%	0%	no	very good
LUTRON - SKYLARK	SELV-303P	100%	0%	no	very good
LUTRON - SKYLARK	CTELV-303P	100%	0%	no	very good
LUTRON - DIVA	DVELV-300P	100%	0%	no	very good
LEGRAND - ADORNE	TRUE UNIVERSAL	100%	30%	no	good

DIMMER LIST COMPATIBILITY FOR G9 LED BULBS – 230V

<u>DIMMER BRAND</u>	<u>MODEL NUMBER</u>	<u>MAX LEVEL</u>	<u>MIN LEVEL</u>	<u>FLICKERING</u>	<u>OVERALL QUOTE</u>
VARILIGHT	V-PRO	100%	2%	no	very good
LEGRAND - NILOÉ	3 996 35	87%	15%	no	good
NIKO	310-0280X	94%	5%	no	very good
NIKO	310-0190X	100%	1%	no	very good

*Other dimmers can yield good results and we recommend conducting your own test before final installation.