







## SAINTE 05

Sainte is a collection about the forces that anchor us, a suspension light in dialogue with gravity. Reimagining the rectangle in layered, colourful glass, Sainte offers an elegant floating mass supported by robust nylon ribbons. Powered by a flat wire embedded in the nylon, these anchors carry a casual, contemporary spirit: an everyday material flirting with its graceful, minimalist centre. The form can suspend from any angle and height, and in multiples, offering infinite architectures and possibilities. As a collection, it presents a dance of contrasting materials and an equilibrium of opposing powers.

<b>type:</b>	suspension
<b>construction:</b>	aluminum polished light block and ceiling anchors float glass body nylon ribbon PMMA frosted diffuser
<b>specifications:</b>	source: LED array, integrated power consumption: 11W colour temperature 2700k, 3000k, dim to warm. see order guide colour rendering index: ≥90 CRI colour consistency: 3 SDCM expected lifetime: 50 000h
<b>control:</b>	120-277V: On/Off, 0-10V, Phase Dimming (120V only) 220-240V: On/Off, 0-10V, Phase Dimming (Trailing Edge only) refer to our recommended list of dimmer models
<b>ribbon length:</b>	20' / 610 cm, width: 1.5" / 3.8 cm
<b>weight:</b>	15.1 lb / 6.8 kg
<b>certifications:</b>	    IP20
<b>warranty:</b>	2 years

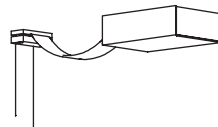

Canopy  
W: 5" / 12.7 cm  
L: 7" / 17.8 cm  
H: 1.7" / 4.3 cm

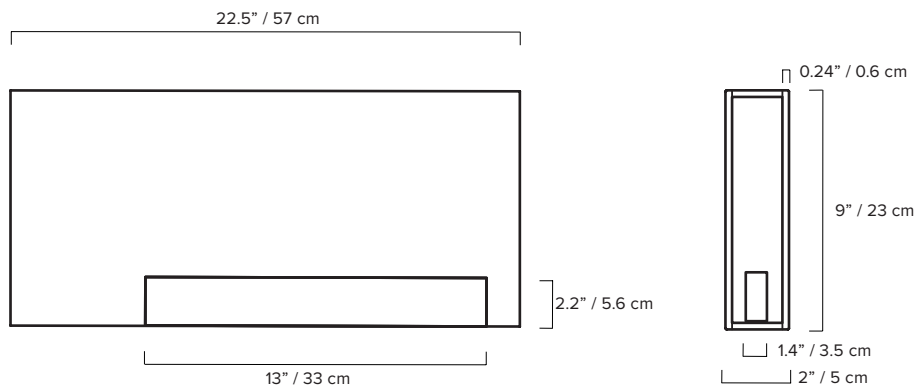

## ORDER GUIDE: SKU

COLLECTION	MODEL	GLASS BODY SIDE A	GLASS BODY SIDE B
<b>STE</b> sainte	<b>05</b>	<b>BK</b> black	<b>BK</b> black
		<b>GY</b> grey	<b>GY</b> grey
		<b>FG</b> frosted grey	<b>FG</b> frosted grey
		<b>EC</b> extra clear	<b>EC</b> extra clear
		<b>FC</b> frosted extra clear	<b>FC</b> frosted extra clear
		<b>GN</b> green	<b>GN</b> green
		<b>BZ</b> bronze	<b>BZ</b> bronze
<b>STE</b>	<b>05</b>	<b>BK</b>	<b>BK</b>

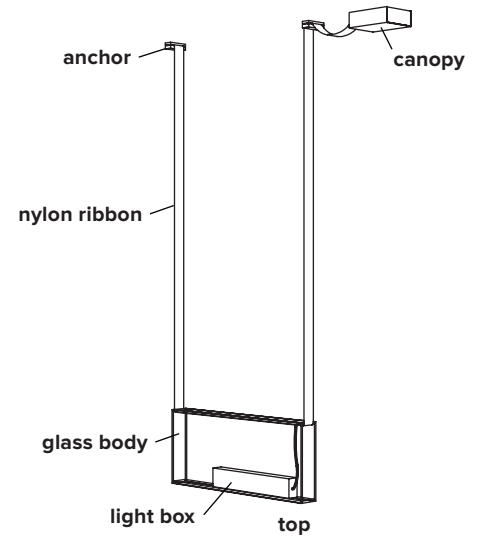

NYLON RIBBON	CANOPY	COLOUR TEMPERATURE (CCT)	CONTROL
<b>BK</b> black	<b>BK</b> black	<b>WL</b> warm light (2700K)	<b>ZT</b> 0-10V dimming
<b>BG</b> beige	<b>WH</b> white	<b>NL</b> neutral light (3000K)	<b>OT</b> 1-10V dimming
		<b>D27</b> dim to warm (2700K to 2200K)	<b>PH</b> phase dimming
		<b>D30</b> dim to warm (3000K to 2200K)	
		<b>V</b> variable	
<b>BK</b>	<b>BK</b>	<b>WL</b>	<b>ZT</b> = <b>STE05BKBKKBKWLZT</b>

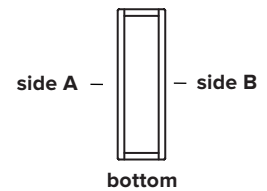

Top and bottom of glass are always ultraclear and not available in color

**example**

### GLASS BODY

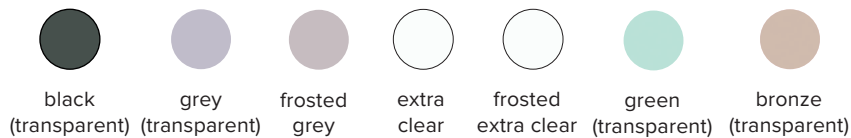

### NYLON RIBBON



### MOUNTING OPTIONS

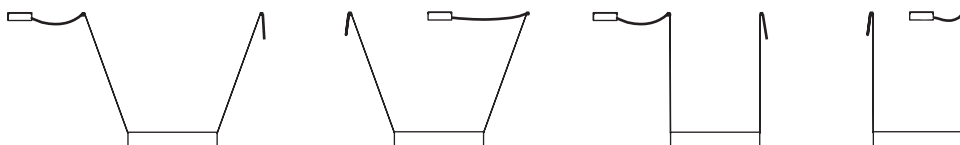

## DIMMER SPECIFICATIONS

### TESTED DIMMER COMPATIBILITY LIST - 120V\*

Compatible with 0-10V, Phase dimming (leading edge or trailing edge\*\*)

Dimmer brand	Model	Dimmer protocol	Min level	Max level
Lutron	TGCL-153P	Phase dimming	14%	98%
Leviton	VPE06	Phase dimming	14%	98%
Lutron	DVELV303P	Phase dimming	11%	98%
Lutron	SELV300P	Phase dimming	11%	98%
Lightolier	ZP260QEW	Phase dimming	11%	98%
Lutron	FAELV500	Phase dimming	17%	99%
Lutron	MAELV600	Phase dimming	18%	98%

### TESTED DIMMER COMPATIBILITY LIST - 230V\*

Compatible with 0-10V, Phase dimming (trailing edge only\*\*)

Dimmer brand	Model	Dimmer protocol	Min level	Max level
Clipsal	32E450UDM	Phase dimming	31%	100%
Clipsal	32E450TM	Phase dimming	25%	100%

Some dimmers require a minimum load, check specifications.

\*Other dimmers can yield good results and we recommend conducting your own test before final installation

\*\*Leading edge is also known as TRIAC or Forward Phase. Trailing edge is also known as ELV or Reverse Phase.

## EU ENERGY LABEL

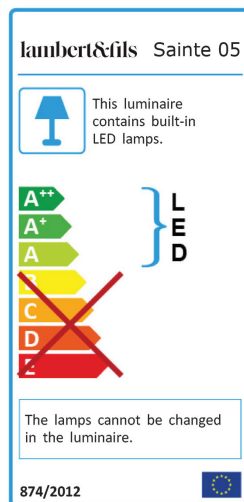

### NOTES:

- must be installed by an electrician
- LED may only be changed by Lambert & Fils or other authorized personnel
- not protected against liquids (refer to IP20)
- additional charges for modifications or for special orders
- please refer to maintenance sheet on website for cleaning instructions