



# Leading Window & Door Systems



# Wintec Aluminium



*Since our beginning in 1997, we have developed a range of window and door products that are innovative, functional and stylish.*

*Wintec Aluminium windows and doors are an all Australian designed and manufactured product, with modern designs and quality finish at the forefront of the Wintec philosophy.*

*An ongoing commitment to product development and service to our Australia wide fabricator base ensures that no matter where you are, you have access to the latest designs in the Window and Door industry.*

## “Australia’s Leading Window and Door Systems”

### Products and Services

#### **Aluminium Windows & Doors**

Wintec have products to suit all areas in Australia – consisting of, Sliding windows, Sliding doors, Awning and Casement windows, Double Hung windows, Louvres, Sliding Multi Track doors, French doors and Bi-folding doors .

#### **Window & Door Testing Laboratory**

The Wintec designed products are tested to Australian standard AS2047-1999 in NATA accredited laboratory No 14093. This ensures your windows and doors comply with the building code of Australia [BCA] and are suited to your particular location. In line with the BCA requirements Wintec windows and doors carry a 7 year guarantee.



# WINFOLD

## Bi-folding Door

### **Structural .**

Featuring Wintec's rounded hollow construction, the Winfold suits door heights up to 3 metres and individual panel widths to 1 metre. Therefore, offering more uninterrupted views without sacrificing strength and safety. Quality marine grade stainless steel hardware is used to ensure product longevity and performance in the harshest of conditions.

### **Weather & Energy .**

Keeping up with Wintec's proven weather performance, the Winfold is ideal for coastal and exposed locations. The Winfold sill is reversible allowing for inward or outward openings. With modern design and utilising quality seals, ensures the Winfold will meet the high demands for energy efficiency and weather performance in today's market.

### **Aesthetics .**

The Winfold features a new and fresh approach to bi-fold styling. Hard square edges are eliminated on the Winfold and replaced with more modern rounded door rails and stiles that give that easy clean, smooth and classy appearance.

### **Additional Benefits .**

Available in double glazing

Multi point locking hardware for better security

Dust seal on head track reduces wear and corrosion

Available in a low profile sill for easy access applications

*\*Rated in accordance with AS2047-1999*



# Winfold Bi-folding Door

- 2 Sill types available; Low Profile and Water Rated
- Reversible sill allows water drainage for both inward and outward opening door configurations
- Rounded stiles and rails for softer aesthetics
- Brush seals in the head and rails reduce dirt and grime build up in guide tracks



# Technical Configurations - Scale 1:2

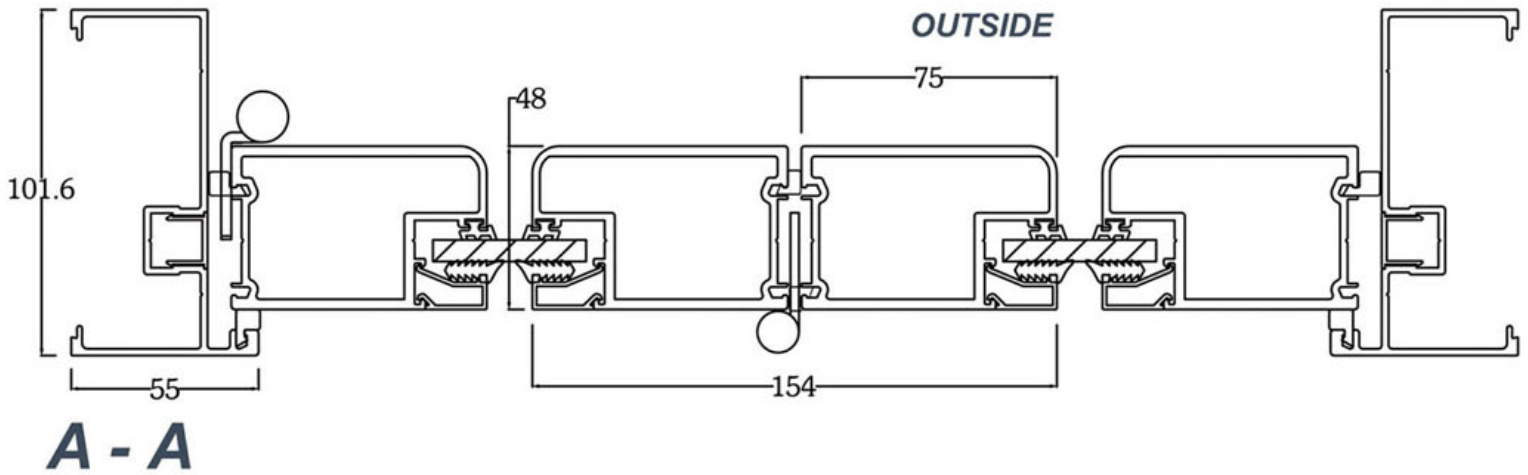

**B - B**

## Typical Winfold / Bi-folding Door -

VIEW FROM OUTSIDE

Various opening configurations

\*Note: 2 Panel minimum - 8 Panel maximum

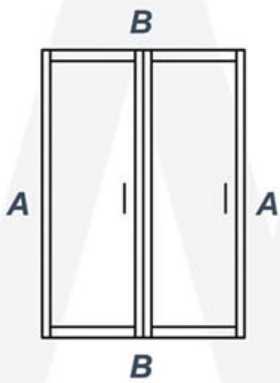

**Standard**  
2 Panel Winfold

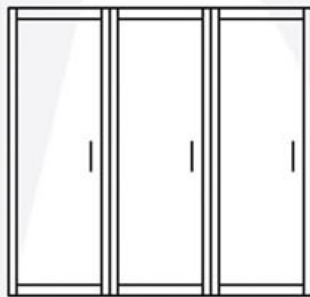

**Standard**  
3 Panel Winfold

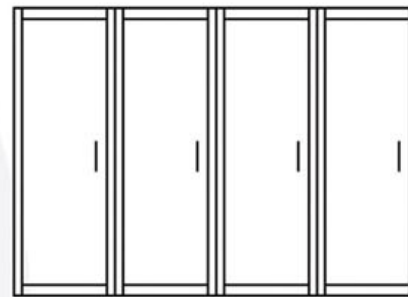

**Standard**  
4 Panel Winfold

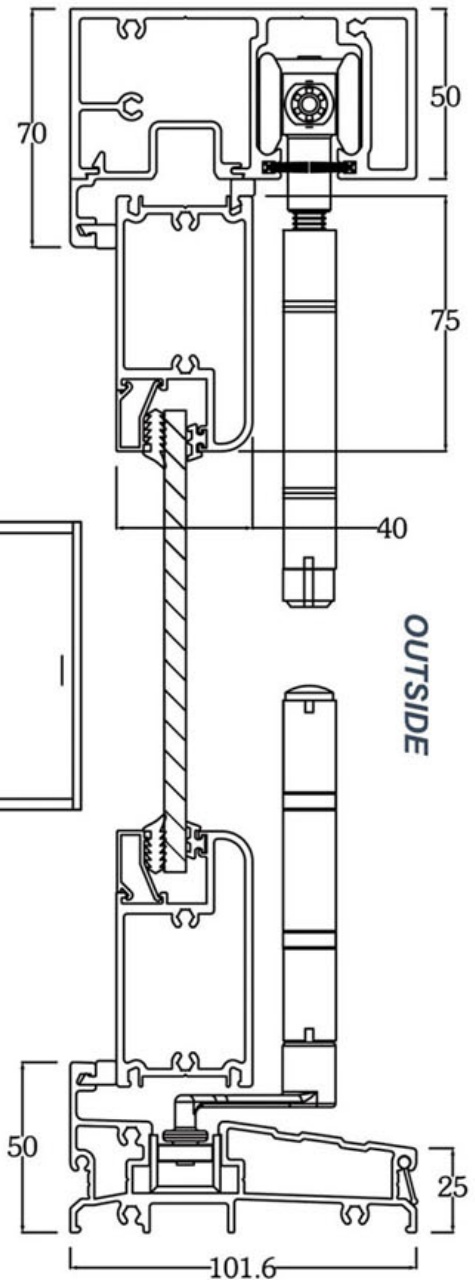

Contact your local Wintec Fabricator for other configuration options.

# CROSS SECTION



P 07 5535 4477 PO Box 2494  
F 07 5535 4744 Burleigh Heads, QLD 4220 [www.wintecaluminium.com.au](http://www.wintecaluminium.com.au)

Leading Window & Door Systems

# Winfold Hardware

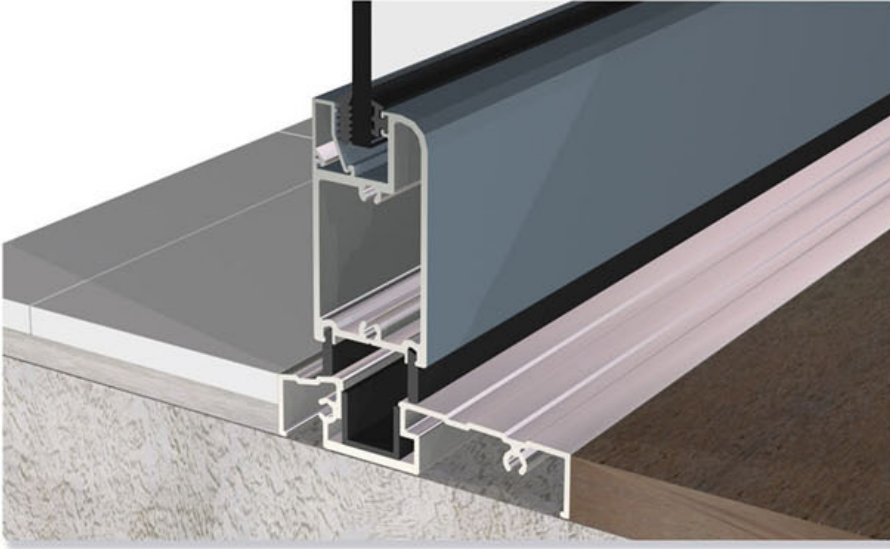

Low profile sill can be flush fitted to timber or tile flooring



Stainless Steel Center Hardware

## Maximum Sizes Table

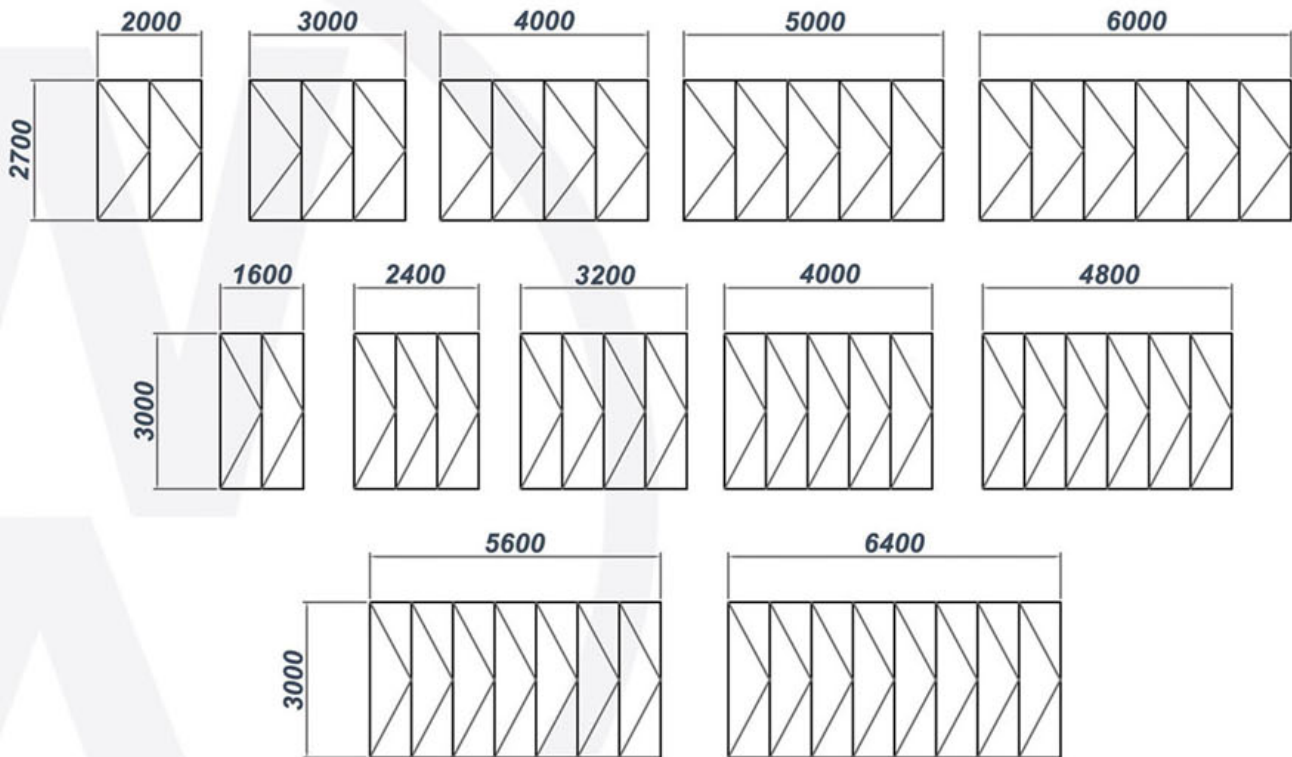

**\*Note:** For products or configurations outside of these sizes, or pressures exceeding 1000Pa please contact your nearest Wintec Fabricator

# ULLRICH

## *Wintec Aluminium Stock*



*Wintec Aluminium sections are stocked  
throughout Ullrich Aluminium branches  
Australia wide*

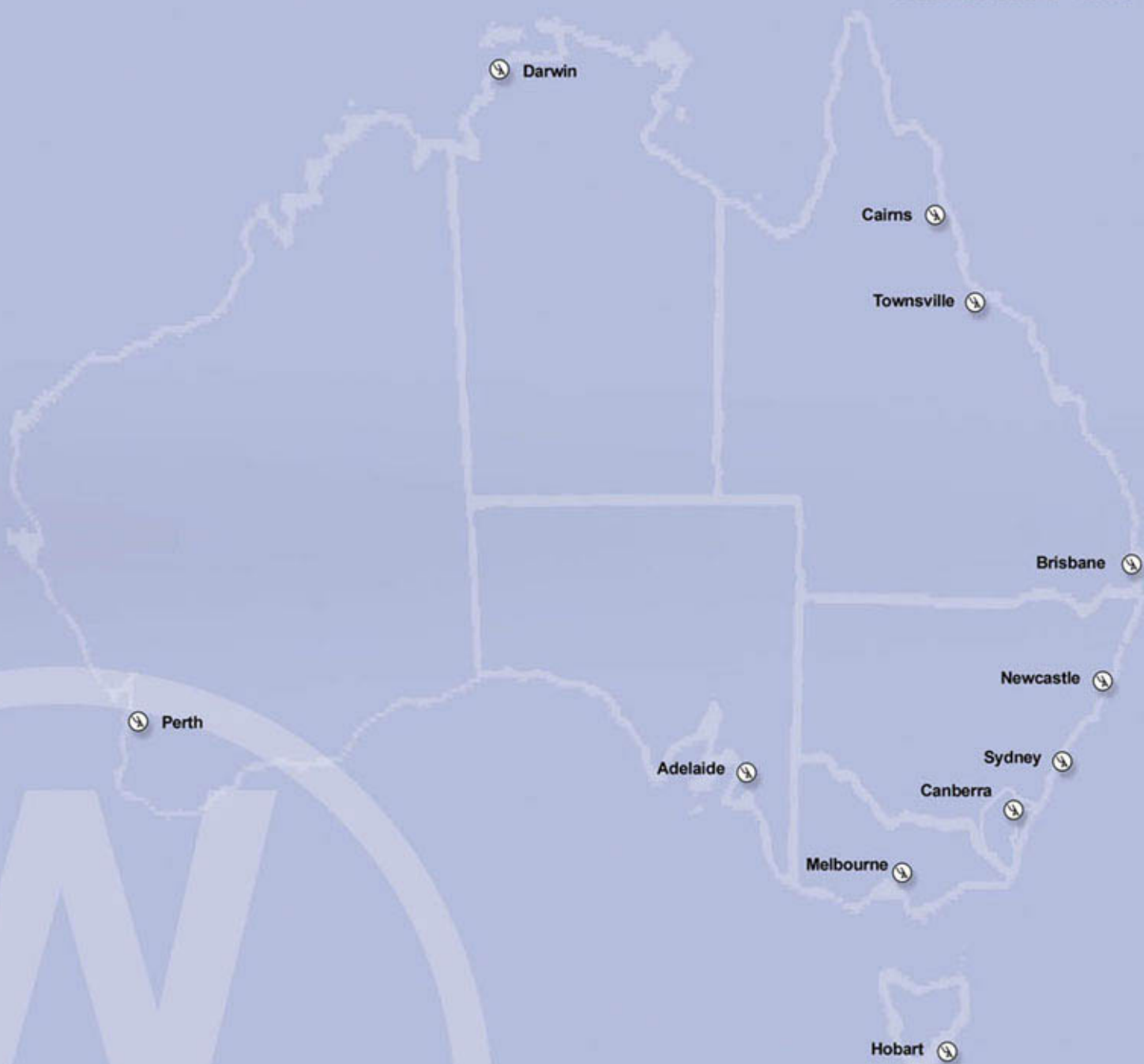

*Looking for more information about  
Wintec Aluminium? Visit us on the web at  
[www.wintecaluminium.com.au](http://www.wintecaluminium.com.au)*