



Toyota Emergency Response Guide



2025.0700
ERG300E

TOYOTA MOTOR CORPORATION

Foreword

- This guide provides precautions for emergency responders when handling TOYOTA vehicles during an incident.
- It is important to read this guide thoroughly and understand the structure and features of TOYOTA vehicles to ensure safety.
- The illustrations used in this guide are representative examples. Refer to the Rescue Sheet for each model for model specific information such as key identification points, component locations, etc.

Table of Contents

Foreword

0. Rescue Sheet

1. Identification / recognition

Components Requiring Special Attention

• High Voltage System	12
• Fuel Cell (FC) System	15
• 48V System	17
• High Intensity Discharge (HID) Headlights	18
• Electric Power Steering (EPS)	19
• EC Mirror	20

Emergency Response Key Points

• Vehicle Identification	22
Appearance and Logos	22
Frame Number	24
Vehicle Identification Number (VIN)	25

2. Immobilisation / stabilisation / lifting

Emergency Response Key Points

• Immobilise Vehicle	27
Vehicle with High Voltage Battery	30
Vehicle with Hydrogen Gas	30
• Stabilise Vehicle	33

3. Disable direct hazards / safety regulations

Components Requiring Special Attention

• High Voltage System	35
High Voltage Power Cable	36
Inverter/Converter	37
DC/DC Converter	37
HEV/BEV/FCEV Transmission	38
HEV/BEV/FCEV Transaxle	
Rear Drive Motor	38
A/C Compressor	39
Coolant Heater	39
Plug-in Charging System	40
Accessory Socket (AC220V / 1500W, AC220V / 2400W)	43
ESU (Electricity Supply Unit)	44

• Fuel Cell (FC) System	45
FC Water Pump and Hydrogen Pump Inverter	45
FC Boost Converter	46
FC Air Compressor	46
FC Water Pump	47
• Solar Charging System	48
1st generation solar charging system	48
2nd generation solar charging system	50
• Solar Powered Ventilation System	52
• Cable cut	53
• Low voltage device that disconnects high voltage	54
• Interlock Connector	55

Emergency Response Key Points

• Disable Vehicle	57
Vehicle with High Voltage Battery	63
Vehicle with Plug-in Charge System	64
Vehicle with Hydrogen Gas	66

4. Access to the occupants

Components Requiring Special Attention

• Doors	68
Flush Handle Type	68
e-latch Handle	69
Door Open Switch	71
Access Door (Double door)	72
Back Door	73
• Structural Reinforcements	74
Side Impact Protection Beam	74
Ultra High Tensile Strength Sheet	74
• Carbon Fibre Reinforced Plastic (CFRP)	75
• Window Glass	76
Laminated Glass	77
Tempered Glass	77
• Front Seat	78
Manual Seat	78
Power Seat	79
• Rear Seat	82
Manual Seat	82
Power Seat	84
• Headrest	85
Manual Headrest	86
Power Headrest	87

• Active Headrest System	88
• Tilt & Telescopic Steering	89
Manual Tilt & Telescopic	89
Power Tilt & Telescopic	90

Emergency Response Key Points

• Access Occupants	92
Vehicle with High Voltage Battery	93
Vehicle with Hydrogen Gas	93
Cut Vehicle	94

5. Stored energy / liquids / gases / solids

Components Requiring Special Attention

• Battery low voltage	97
12 V Battery	97
Sub-battery	99
• Ultra-capacitor, low-voltage	101
• High Voltage System	102
High Voltage Battery	102
• Fuel Cell (FC) System	105
FC Stack	105
Hydrogen Tank	106
Hydrogen Pipes	107
Hydrogen Pump	108
• CNG Tank	109
• LPG Tank	110
• Air Tank	111
• Urea Selective Catalytic Reduction (SCR) System	112

Emergency Response Key Points

• Spills	114
Coolant	114
Lubrication Oil	114
Brake Fluid	114
Power Steering Fluid	114
Window Washer Fluid	114
12 V Battery Electrolyte	115
Sub-battery Electrolyte	115
48V Battery Electrolyte	116
Vehicle with High Voltage Battery	116
Traction Battery Coolant	117
Vehicle with Solar Battery	117
Vehicle with Urea Solution	118
Vehicle with Hydrogen Gas	118

• Gas Leaks	119
Nitrogen (N2) Gas	119
Refrigerant Gas	119
Vehicle with CNG	119
Vehicle with LPG	119
Vehicle with Hydrogen Gas	119

6. In case of fire

Emergency Response Key Points

• Fire	121
Fire Extinguisher	121
Vehicle with High Voltage Battery	121
Vehicle with Lithium ion (Li-ion) Battery	122
Vehicle with Urea Solution	122
Vehicle with Hydrogen Gas	122

7. In case of submersion

Emergency Response Key Points

• Submersion	125
Vehicle with High Voltage Battery	125

8. Towing / transportation / storage

Damaged Vehicle Handling Key Points

• Towing Damaged Vehicle	127
Parking Lock	127
Steering Wheel Lock	128
Steer-by-Wire System	128
Precautions for FF (Front-engine Front-wheel drive) vehicle	129
Precautions for FR (Front-engine Rear-wheel drive), MR (Mid-engine Rear-wheel drive) and 4WD (Four Wheel Drive) vehicles	129
Vehicle with High Voltage Battery	130
• Storing a Damaged Vehicle	131
Submerged Vehicle	131
Vehicle with High Voltage Battery	131
Vehicle with Hydrogen Gas	134
Vehicle with Sub-battery	134

9. Important additional information

Components Requiring Special Attention

• SRS Airbags	136
Driver Airbag	139
Passenger Airbag	139
Front Knee Airbag	140
Front Seat Side Airbag	141
Front Seat Centre Airbag	142

Front Seat Cushion Airbag	143
Curtain Shield Airbag	143
Rear Seat Side Airbag	144
Rear Seat Cushion Airbag	145
Back Window Curtain Shield Airbag	145
• Automatic rollover protection system	146
• Seat belt pretensioner	147
• Pedestrian protection active system	149
• Gas strut / Preloaded spring	151
Front and Rear Suspension Dampers	151
Engine Bonnet Damper	152
Luggage Compartment, Hatchback Door, Back Door Dampers	152
Performance Damper	153
Tail Gate Damper, Side Gate Damper	154
Seat Damper	155

10. Explanation of pictograms used

11. Rescue sheets

Vehicle Rescue Sheets

86 (ZN6)	161
GR86 (ZN8)	163
Aurion (GSV50)	167
BbZ4X (XEAM10, YEAM15)	169
Camry (ASV50)	173
Camry Hybrid (AVV50)	175
Camry (ASV70 & GSV70)	177
Camry Hybrid (AXVH71)	179
Camry Hybrid (AXVH80)	181
Coaster (XZB70 & GBD70)	185
Corolla Sedan (ZRE172)	187
Corolla Hatch (ZRE182)	189
Corolla Hybrid (ZWE186)	191
Corolla Hatch (MZEA12)	193
Corolla Hybrid Hatch (ZWE211)	195
Corolla Sedan (MZEA12)	197
Corolla Hybrid Sedan (ZWE211/ZWE219)	199
Corolla Cross (MXGA10)	201
Corolla Cross Hybrid (MXGH10 & MXGH15)	205
GR Corolla (GZEA14)	209
C-HR (NGX10/NGX50)	213
C-HR Hybrid (ZYX10)	215
C-HR Hybrid (MAXH25, ZYX20)	217
Fortuner (GUN156)	221

Table of Contents

Hiace (TRH201/KDH201)	223
Hiace (TRH22#/KDH22#)	225
Hiace (GRH300/GDH300) (up to 06/2025)	227
Hiace (GRH300/GDH300) (from 06/2025)	229
Hiace/Granvia (GRH303/GDH303)	233
Hiace (GRH320/GDH320) (up to 06/2025)	235
Hiace (GRH320/GDH320) (from 06/2025)	237
Hilux Double Cab (TGN121/GGN12#/GUN12#/GUN13#)	241
Hilux Single Cab (TGN121/GGN12#/GUN12#/GUN13#)	243
Hilux Smart Cab (TGN121/GGN12#/GUN12#/GUN13#)	245
Kluger (GSU50/55)	247
Kluger (GSU70/75 & TXUA70/75)	249
Kluger Hybrid (AXUH78) (up to 11/2023)	253
Kluger Hybrid (AXUH78) (from 11/2023)	257
LandCruiser 70 Wagon (GDJ/VDJ76)	261
LandCruiser 70 Troop Carrier (GDJ/VDJ78)	263
LandCruiser 70 Double Cab Chassis (GDJ/VDJ79)	265
LandCruiser 70 2 Door (GDJ/VDJ79)	267
LandCruiser 200 (URJ202/VDJ200)	269
LandCruiser 300 (FJA300)	271
LandCruiser Prado 150 (GRJ150/GDJ150)	275
LandCruiser Prado 250 (GDJ251)	277
Mirai (JPD10)	281
Mirai (JPD20) (up to 12/2023)	283
Mirai (JPD20) (from 12/2023)	287
Prius (ZVW50)	291
Prius C (NHP10)	293
Prius V (ZVW40)	295
RAV4 (ZSA42/ASA44/ALA49)	297
RAV4 (MXAA52/AXAA54)	299
RAV4 Hybrid (AXAH52/AXAH54)	301
Supra (DB42)	303
Tarago (ACR50/GSR50)	305
Tundra (VXKH75) (up to 08/2025)	307
Tundra (VXKH75) (from 08/2025)	311
Yaris 3 Door (NCP130)	315
Yaris 5 Door (NCP130)	317
Yaris 3 Door (NCP130) (with rear seat belt pretensioners)	319
Yaris 5 Door (NCP130) (with rear seat belt pretensioners)	321
Yaris (MXPA10)	323
Yaris Cross (MXPB10)	327
Yaris Cross Hybrid (MXPJ10 & MXPJ15) (up to 01/2024)	331
Yaris Cross Hybrid (MXPJ10 & MXPJ15) (from 01/2024)	335
Yaris Hybrid (MXPH10) (up to 04/2024)	339
Yaris Hybrid (MXPH10) (from 04/2024)	343
GR Yaris (GXPA16)	347

0. Rescue Sheet

- With regards to the detailed information for each vehicle, refer to the rescue sheet for the respective vehicle on Toyota Motor's public website.

HP of each store

Australia	https://toyotamanuals.com.au/#/
-----------	---

Components Requiring Special Attention

- The construction and functions of components requiring special attention during emergency response are described in this section.
- With regards to the pictograms used, refer to chapter 10. Explanation of pictograms used (P156)



High Voltage System

- Hybrid vehicles (HEV), plug-in hybrid vehicles (PHEV), electric vehicles (BEV) and fuel cell vehicles (FCEV) use a motor driven by high voltage electricity (120V - 800V) to generate the driving torque. These vehicles are equipped with high voltage electrical components such as a high voltage battery, inverter/converter, transmission/transaxle (electric motor), A/C compressor, charger and voltage inverter as well as high voltage power cables.
- Refer to the Fuel Cell (FC) system (see page 45) for information on the high voltage parts specific to fuel cell vehicles (FCEV).
- High voltage electrical components can be indicated by markings on their case/cover. High voltage power cables are indicated by an orange colour.
- The cases/covers of the high voltage electrical components are insulated from the high voltage conductors inside the components. The vehicle body is insulated from the high voltage electrical components, and is safe to touch during normal conditions.
- The READY indicator in the combination meter turns on while the high voltage system is operating.

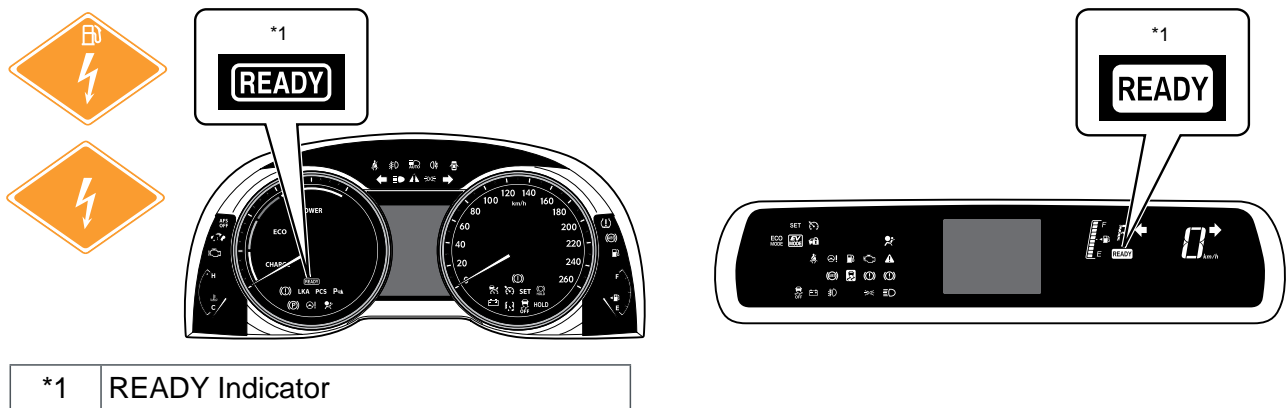

- The high voltage system is deactivated when the ignition switch or power switch is turned OFF. If an impact is detected (SRS airbag is activated) or if a high voltage leakage is detected, the high voltage system is automatically deactivated. When the high voltage is shut off, the READY indicator turns off. However, if the remote air conditioning system or plug-in charging system are being used, even if the READY indicator turns off, the high voltage system may still be active.
- For fuel cell vehicles (FCEV), even if the READY indicator turns off, the high voltage system may still be active if the H₂O indicator in the combination meter is illuminated.

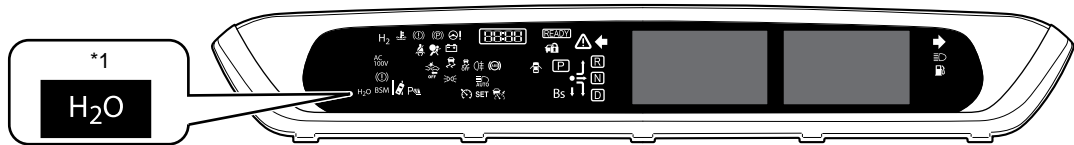

*1	H ₂ O Indicator
----	----------------------------

- There are 2 types of batteries for the high voltage battery. A nickel metal hydride (Ni-MH) battery and a Lithium-ion (Li-ion) battery.
 1. Nickel metal hydride (Ni-MH) battery (120 to 400 V)
 2. Lithium-ion (Li-ion) battery (120 to 800 V)
- Refer to the Rescue Sheet for each model for the locations of the high voltage electrical components.



WARNING

- The high voltage system may remain charged for up to 10 minutes after the vehicle is shut off and disabled (see page 57) Failure to shut off and disable the vehicle before emergency response procedures are performed may result in serious injury or death from severe burns and electric shock from the high voltage electrical system.
- To prevent serious injury or death from severe burns or electric shock, avoid touching, cutting, or breaching any orange high voltage power cable or high voltage component. Wear appropriate protective equipment such as insulated gloves when there is a risk of touching high voltage power cables or high voltage components.
- When the person(s) in charge of handling the damaged vehicle is away from the vehicle, other person(s) may accidentally touch the vehicle and be electrocuted, resulting in severe injury or death. To avoid this danger, display a “HIGH VOLTAGE DO NOT TOUCH” sign to warn others (print and use page 14 of this guide).



Person in charge: _____

CAUTION:
HIGH-VOLTAGE
DO NOT TOUCH.

CAUTION:
HIGH-VOLTAGE
DO NOT TOUCH.

Person in charge: _____

When performing work on the HV system, fold this sign and put it on the roof of the vehicle.



Fuel Cell (FC) System

- Fuel cell vehicles (FCEV) use a motor for driving force in the same way as hybrid vehicles. In order to drive the motor, a high voltage (over 200 V, up to 650 V) is used. Not having an engine, the vehicle uses a motor driven by the power generated by a chemical reaction between the hydrogen fuel and oxygen in the air.
- Fuel cell vehicles (FCEV) are equipped with dedicated high voltage components such as an FC stack, hydrogen pump, FC water pump, FC water pump and hydrogen pump inverter, FC boost converter and FC air compressor.
- To use hydrogen for power generation, fuel cell vehicles (FCEV) are equipped with hydrogen pipes and hydrogen-related parts such as an FC stack, hydrogen tanks, etc.
- The hydrogen tanks are filled with high pressure hydrogen gas (a maximum of 70 MPa (714 kgf/cm², 10,153 psi) at 15°C (59°F)).
- The hydrogen-related parts are inside cases/covers. Also, some of the insulation on high-pressure hydrogen pipes is in red.
- Hydrogen gas is colourless, odorless, and harmless.
- Hydrogen gas is flammable, and can ignite in a wide range of concentrations (4 to 74.5%). However, it diffuses easily and tends not to accumulate, so a small amount of leak would quickly dissipate to a concentration that cannot ignite.
- In case of hydrogen leakage, the hydrogen detector equipped on the vehicle detects the hydrogen leak and shuts off the supply of hydrogen by means of solenoid valves on the tank to prevent a mass leak. Also, hydrogen-related parts are located outside the cabin to allow leaked hydrogen to be easily diffused.
- If a collision is detected, the supply of hydrogen is shut off to prevent a mass leak due to vehicle damage.
- For details about the installation locations of hydrogen-related parts, refer to the Rescue Sheet for the vehicle.



WARNING

- If the sound of hydrogen leaking (a loud hissing sound) can be heard when working on the vehicle, or if the hydrogen concentration around the vehicle exceeds 1% when measured with a hydrogen concentration detector, immediately step away from the vehicle as there is a chance that the hydrogen gas may ignite.
- Even after the vehicle is stopped (see page 57), hydrogen remains inside the FC stack, hydrogen tanks and other hydrogen-related parts, as well as inside the hydrogen pipe. In order to avoid fires and explosions, never cut or damage these hydrogen-related parts or the hydrogen pipe.
- When the person(s) in charge of handling the damaged vehicle are away from the vehicle and someone else accidentally approaches or touches the vehicle, death or serious injury may occur due to electrocution, a rupture, an explosion or fire. To avoid this danger, display "HIGH VOLTAGE DO NOT TOUCH" and "HIGH-PRESSURE GAS DO NOT TOUCH" signs to warn others (print and use page 14 and 16 of this guide).



Person in charge: _____

CAUTION:
HIGH-PRESSURE GAS
DO NOT TOUCH.

CAUTION:
HIGH-PRESSURE GAS
DO NOT TOUCH.

Person in charge: _____

48V System

- The 48V system is composed of the 48V control starter generator motor, 48V control with converter ECU and 48V battery.
- The 48V system voltage from the 48V control starter generator motor and 48V battery is dropped in order to supply power to electrical components and the auxiliary battery.
- The 48V control starter generator motor performs engine motive force assist, generates power while driving, and performs regeneration when the accelerator pedal is released.
- The 48V control with converter ECU starts and stops the engine, and controls engine assist and regeneration, based on signals from sensors, switches, and ECUs.

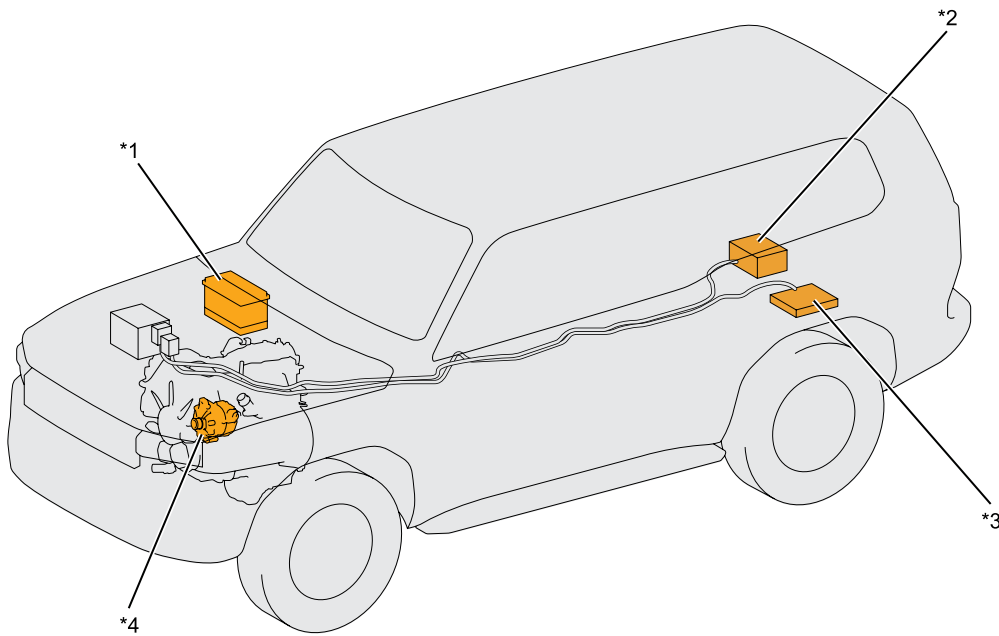

*1	12V Battery	*2	48V Battery
*3	48V Control With Converter ECU	*4	48V Control Starter Generator Motor

High Intensity Discharge (HID) Headlights

- Headlights use High Intensity Discharge (HID) bulbs, which emit light by creating an electric discharge between electrodes inside the bulbs.
- When the HID headlights are turned on, high voltage of approximately 20,000 to 30,000 V is generated instantaneously. During illumination, the voltage from the 12 V battery is boosted to a maximum of 45 V in the electric circuit of the discharge headlights to drive the discharge headlights.

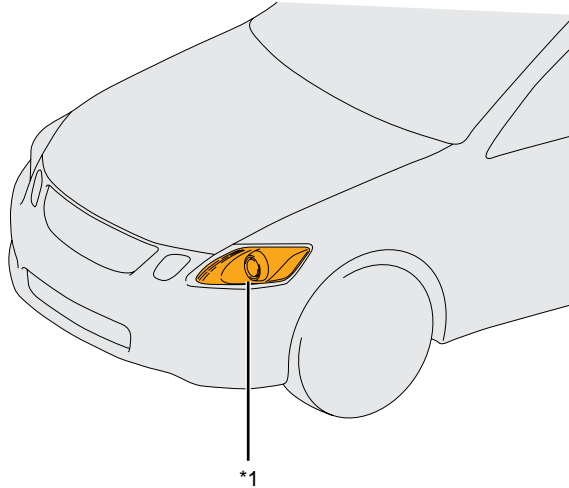

*1 Discharge Headlights



WARNING

- To prevent serious injury or death from electric shock, avoid touching, cutting, or breaching the bulb, socket, electric circuit and components of the headlights.
- To prevent burns, avoid touching the metal parts on the back of the headlights and the high voltage sockets while the discharge headlights are turned on or immediately after they are turned off.

Electric Power Steering (EPS)

- The Electric Power Steering (EPS) system uses 12 V voltage which has been boosted to up to 46 V by the EPS ECU to drive an EPS assist motor.
- The EPS assist motor is built into the steering gear box or steering column.
- Some hybrid models use voltage from the high voltage battery to drive the EPS assist motor by lowering it to up to 46 V using an EPS the DC/DC converter.
- A wire which conducts up to 46 V connects the EPS ECU in the engine compartment or the instrument panel to the EPS assist motor.

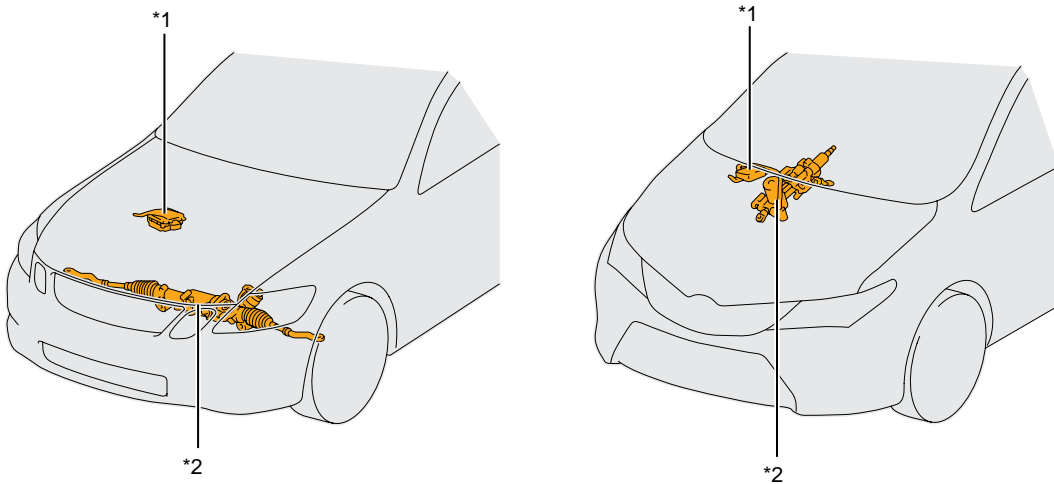

*1	EPS ECU	*2	EPS Assist Motor
----	---------	----	------------------

- The Dynamic Rear Steering (DRS) system equipped on some vehicle models uses 12 V voltage which has been boosted to up to 34 V by the DRS ECU to drive the DRS assist motor.

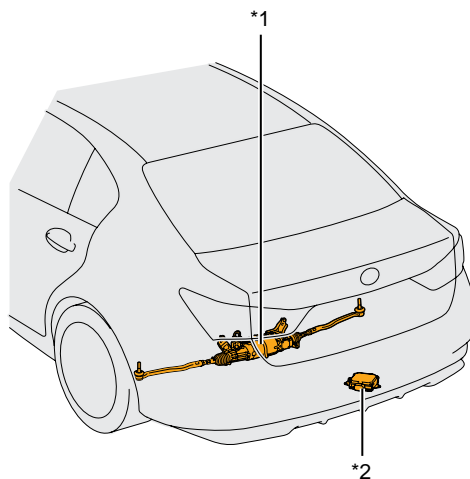

*1	DRS Assist Motor	*2	DRS ECU
----	------------------	----	---------

EC Mirror

- The inner rear view mirror has an auto glare-resistance function, which automatically changes the reflection rate of the mirror. This is done by controlling voltage applied to an electrochromic gel inside the mirror, according to the brightness sensed by a light sensor.

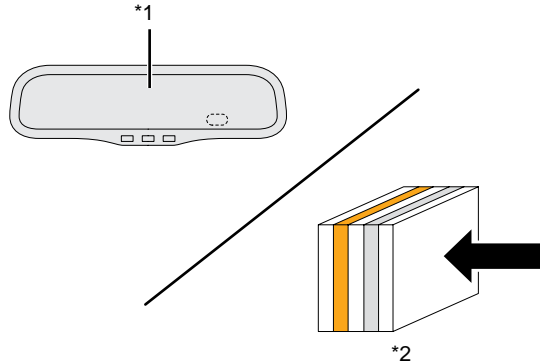

*1	Inner Rear View Mirror	*2	Electrochromic Gel
----	------------------------	----	--------------------

- The electrochromic gel contains organic solvents.



- Organic solvents may cause irritation of the skin if contacted. Wear appropriate protective equipment such as rubber gloves and safety goggles when there is a risk of touching electrochromic gel.

Emergency Response Key Points

- Procedures and points to be noted when handling TOYOTA vehicles during emergency response are provided in this section.
- Refer to the Rescue Sheet for each model for model specific information such as vehicle identification points, component locations, etc.

Vehicle Identification

Appearance and Logos

- Identify the vehicle type based on exterior features and logos on the body.
- Logo marks represent the make, model, grade, and the vehicle type (HEV/BEV/FCEV) if it uses a high voltage electrical system.
- Logo marks are attached to the boot lid, back door/hatch, rocker panels, front grille and fender.

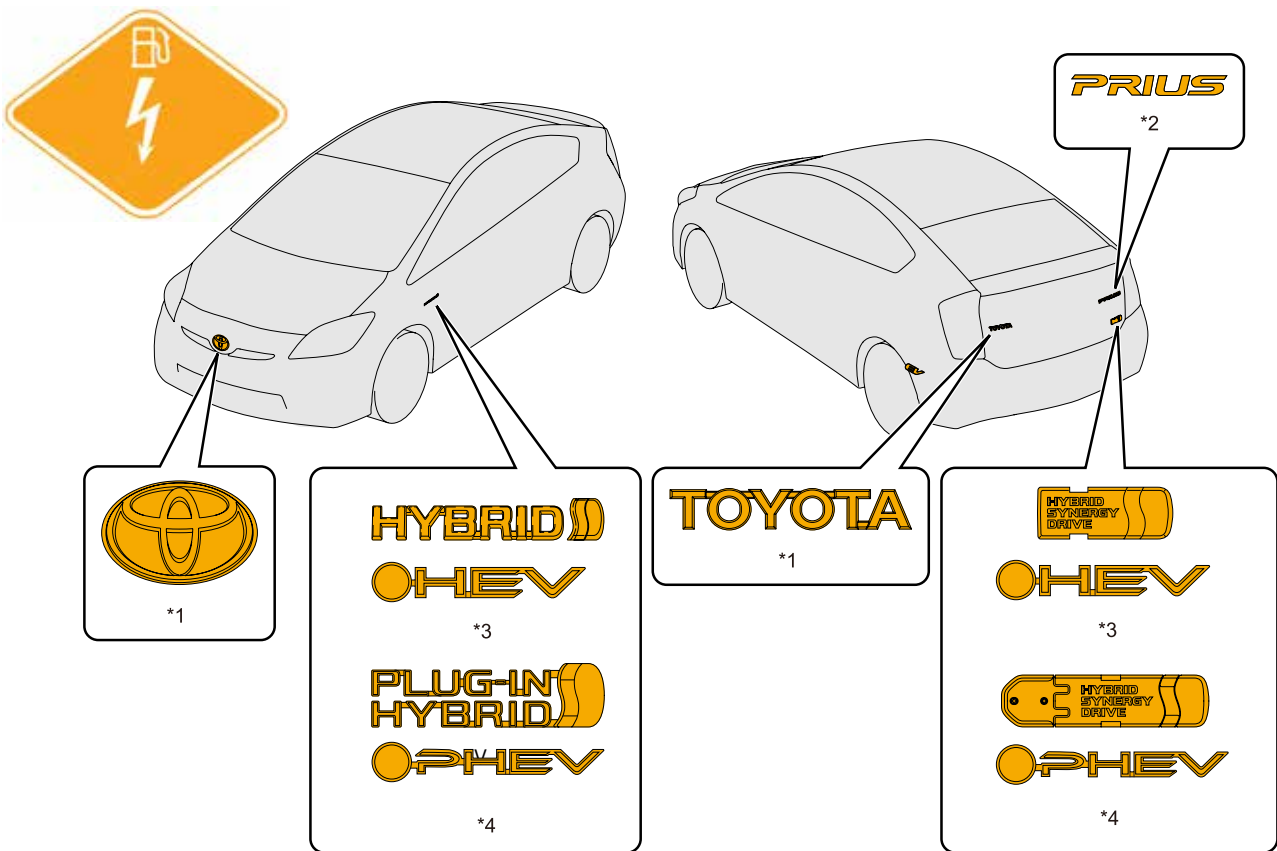

*1	Brand Logo	*2	Model/Grade	*3	Hybrid
*4	Plug-in-Hybrid				

Vehicle Identification

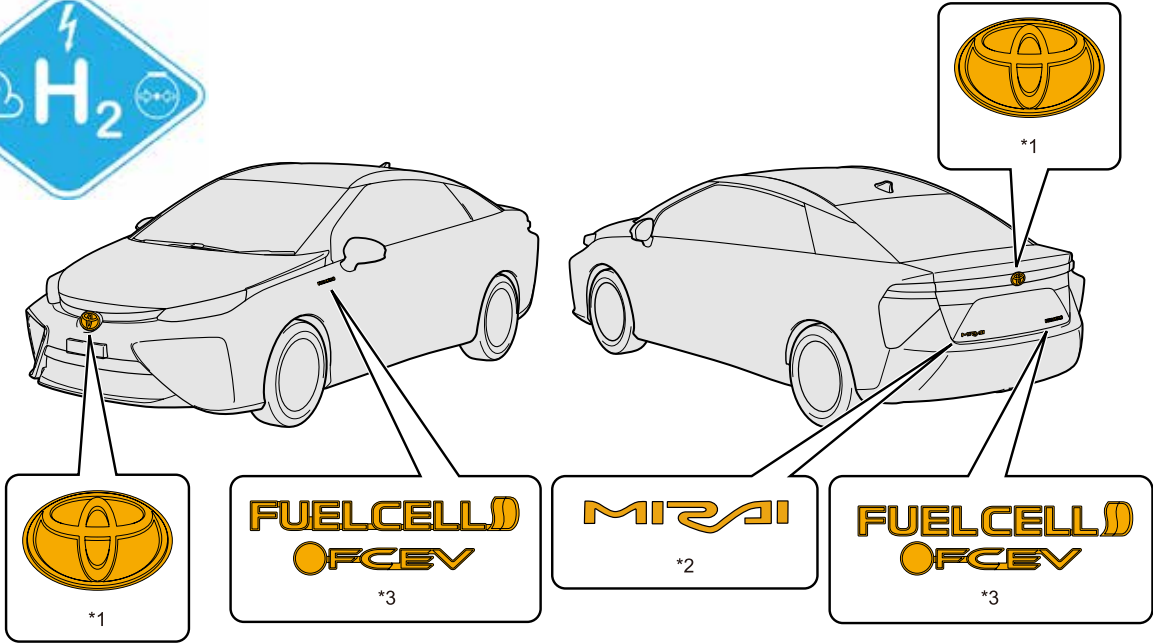

*1	Brand Logo	*2	Model/Grade	*3	Fuel Cell
----	------------	----	-------------	----	-----------

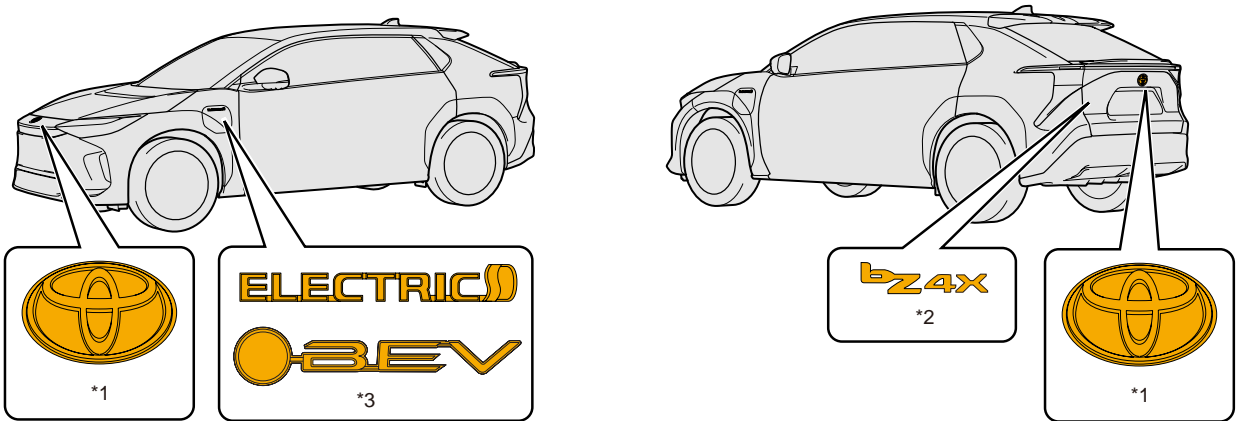

*1	Brand Logo	*2	Model/Grade	*3	BEV
----	------------	----	-------------	----	-----

Frame Number

- A frame number is stamped on the name plate attached to the engine compartment and front passenger door pillar.
- Characters before a hyphen (e.g.: ○○○○ for the frame number ○○○○-△△△△) represent the vehicle model.
- When a cover is installed under the driver seat, a frame number is stamped on the frame underneath the cover.

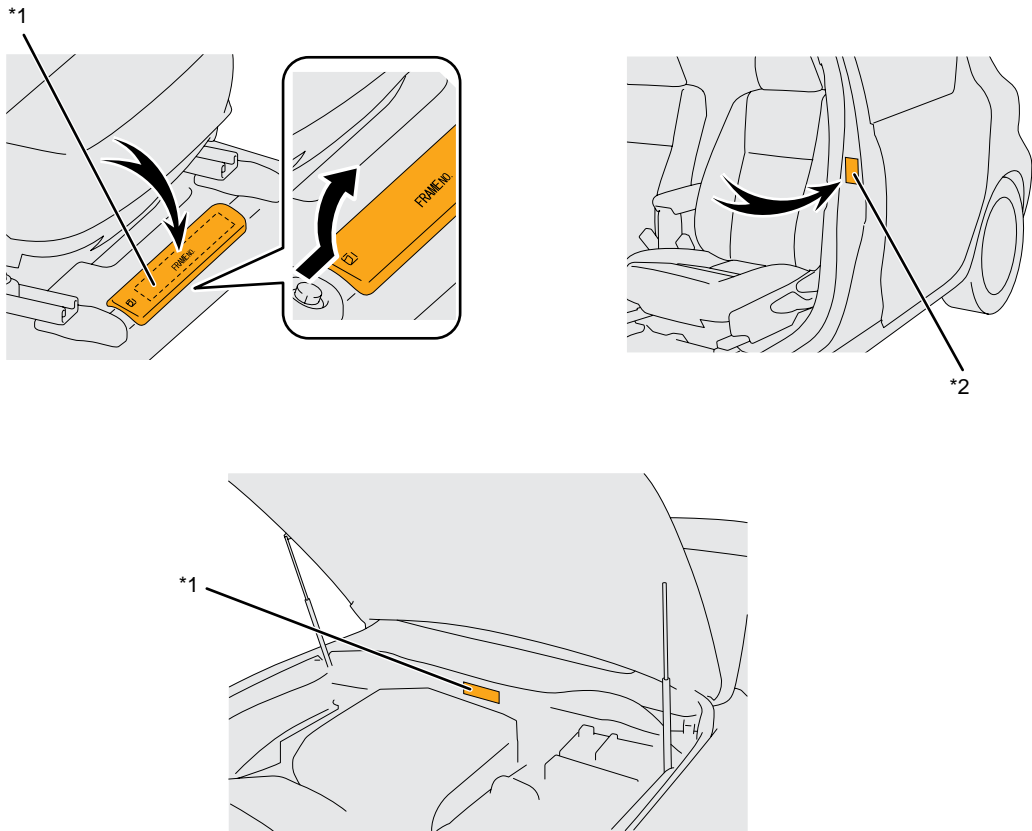

*1	Frame No.	*2	Name Plate
----	-----------	----	------------

Vehicle Identification Number (VIN)

- The VIN is stamped on the name plate attached to the windshield cowl and driver door pillar.
- The vehicle model can be identified by the VIN.

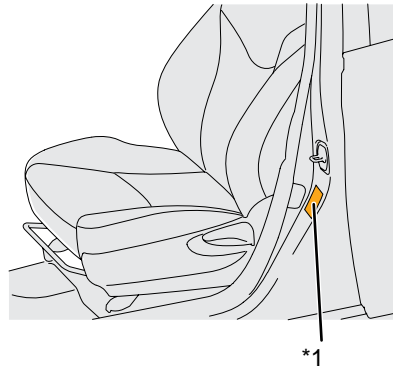
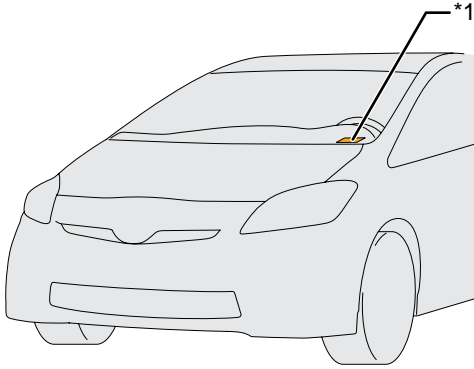

*1	VIN
----	-----

Emergency Response Key Points

- Procedures and points to be noted when handling TOYOTA vehicles during emergency response are provided in this section.
- Refer to the Rescue Sheet for each model for model specific information such as vehicle identification points, component locations, etc.

Immobilise Vehicle

- On arrival, completely immobilise the vehicle by following procedures 1, 2 and 3 to ensure safe emergency response operations.

1. Chock wheels and set the parking brake.

- The following types of parking brakes are available. Operate the parking brake accordingly.

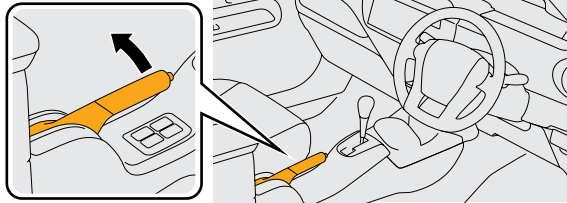

*1

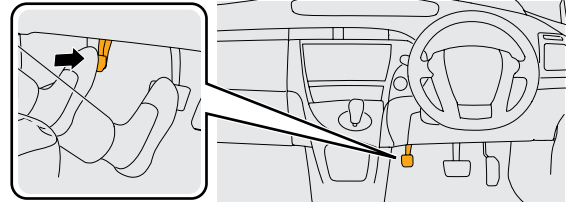

*2

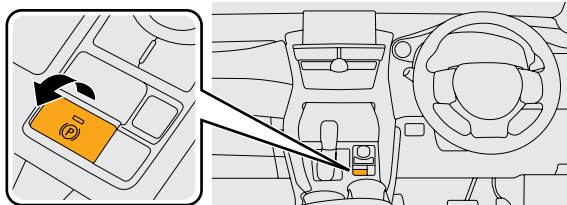

*3

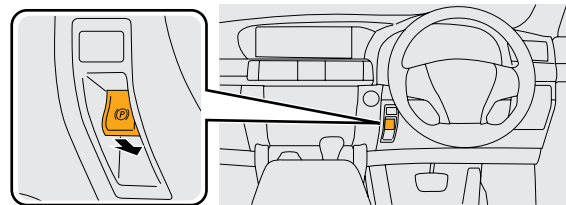

*4

*1	Lever Type	*2	Foot Pedal Type
*3	Switch Type (Pull-type Switch)	*4	Switch Type (Push-type Switch)

- For vehicles with a switch type, operate the switch twice in order to make sure that the vehicle is securely fixed in place.

Immobilise Vehicle

2. For automatic vehicles, move the shift lever to the park (P) position. For manual vehicles, shut off the vehicle (see page 57), then move the shift lever to the 1st or reverse (R).

■ Park (P) can be selected by the following methods. Operate the vehicle accordingly.

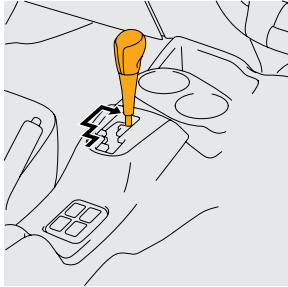

*1

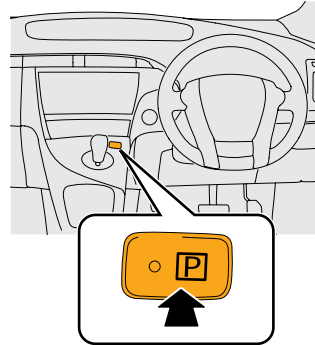

*2

*1	Shift Lever Type	*2	P Position Switch Type
----	------------------	----	------------------------

3. To facilitate emergency response operations, lower the windows, open the back door, unlock the doors and take other necessary actions before shutting off the vehicle.

■ The following systems are powered by the 12 V battery. Operate them as required before disconnecting the battery.

- Power door lock
- Power window
- Power tilt and telescopic steering
- Power seat

Immobilise Vehicle

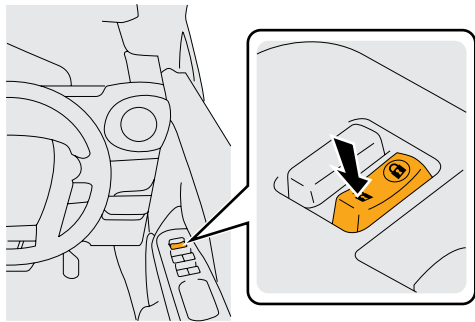

*1

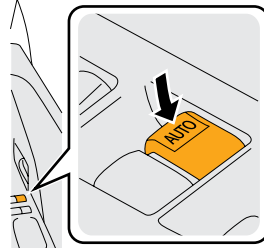
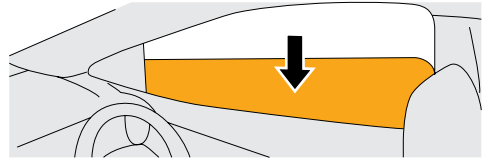

*2

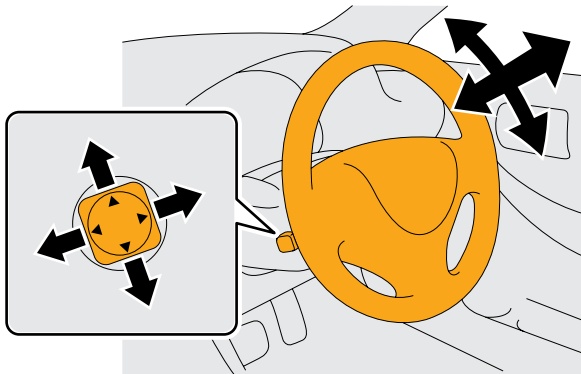

*3



*4

*1	Door Unlock	*2	Power Window Adjustment
*3	Steering Wheel Adjustment	*4	Seat Adjustment



NOTICE

■ Once the 12 V battery is disconnected (see page 57), power controls will not operate.

Vehicle with High Voltage Battery

- Hybrid vehicles (HEV), plug-in hybrid vehicles (PHEV), electric vehicles (BEV) and fuel cell vehicles (FCEV) are equipped with a high voltage electrical system (120 to 800 V).



WARNING

- To prevent serious injury or death from severe burns or electric shock, avoid touching, cutting, or breaching any orange high voltage power cable or high voltage component. Wear appropriate protective equipment such as insulated gloves when there is a risk of touching high voltage power cables or high voltage components.

Vehicle with Hydrogen Gas

- Fuel cell vehicles (FCEV) carry compressed hydrogen gas. Before performing the normal procedures to immobilise the vehicle, follow the steps below first.



WARNING

- Hydrogen gas is colourless, odorless and flammable.
- Compared to petrol or natural gas, hydrogen gas can ignite in a wide range of concentrations (4 to 74.5%). If the sound of hydrogen leaking (a loud hissing sound) can be heard when working on the vehicle, or if the hydrogen concentration around the vehicle exceeds 1% when measured with a hydrogen concentration detector, immediately step away from the vehicle as there is a chance that the hydrogen gas may ignite.



NOTICE

- Depending on the model, multiple hydrogen tanks may be installed. For the detailed installation locations of hydrogen tanks for each model, refer to the Rescue Sheet for each model.

- Confirm that there is no sound of hydrogen leakage (a loud hissing sound).
 - When approaching the vehicle, approach from the front.
 - If the sound of leakage can be heard, immediately step away from the vehicle, as the hydrogen may ignite.
 - Confirm that the sound of leakage is no longer present before proceeding to the next procedure.

2. Using a hydrogen concentration detector, measure the hydrogen concentration around the vehicle, and confirm that it does not exceed 1%.

* For more information about the hydrogen concentration detector, please contact your dealer.

■ If the concentration exceeds 1%, immediately step away from the vehicle, as the hydrogen may ignite.

■ If a ventilator is available, fanning the area can reduce the hydrogen concentration. Blow the fan from the front toward the rear of the vehicle. When approaching the vehicle, approach from the direction where the wind is coming from.

■ Measure the hydrogen concentration at regular intervals and confirm that the hydrogen concentration does not exceed 1% before proceeding to the next step.

3. Immobilise the vehicle according to the normal procedures.

Immobilise Vehicle

4. Flow chart of actions required before performing emergency response procedures

- Make sure to wear insulated gloves and anti-static shoes and check that the hydrogen concentration is below the flammability limit (4%).

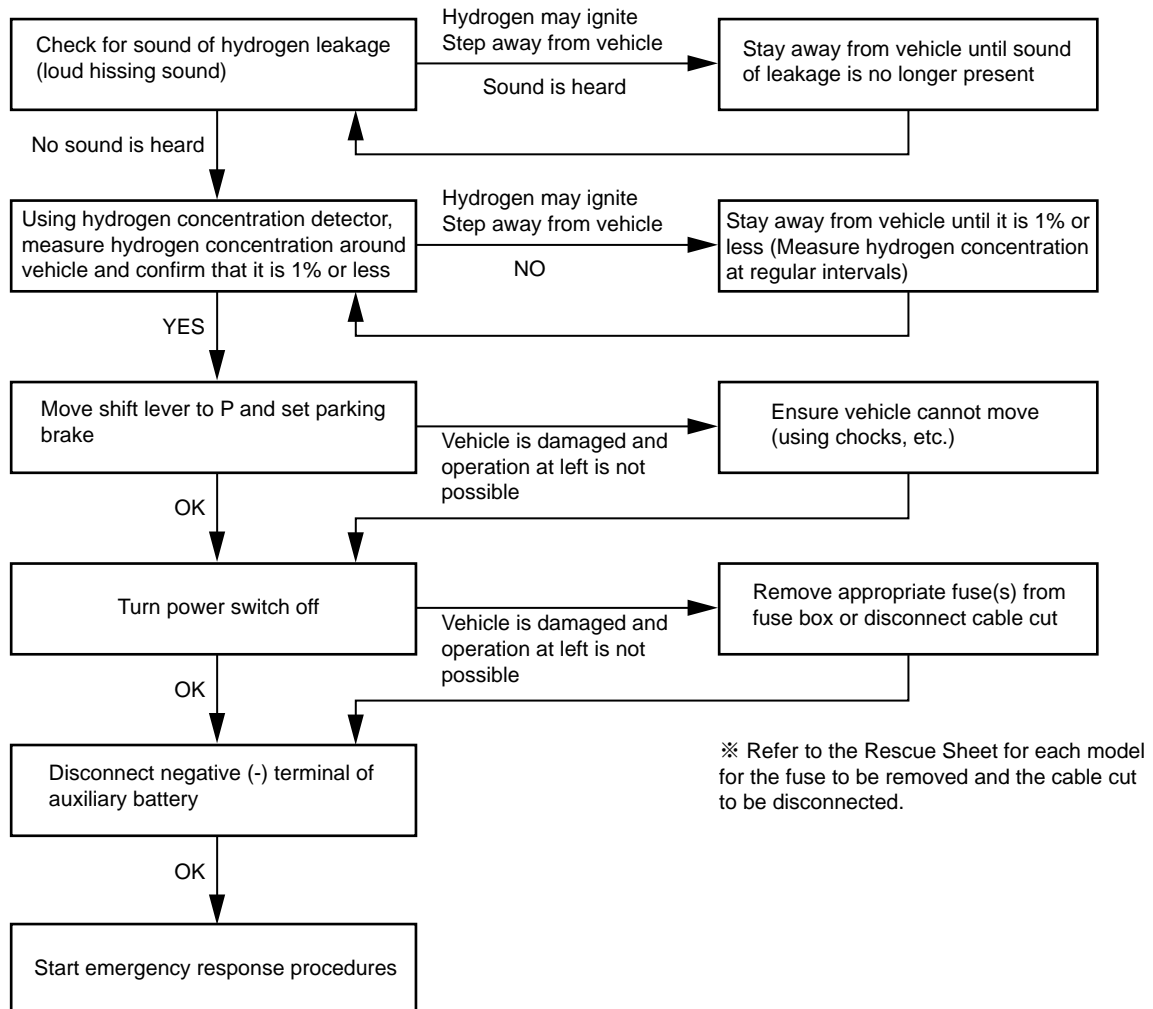

Stabilise Vehicle

- Crib at four points directly under the front and rear pillars using wooden blocks or equivalent objects.

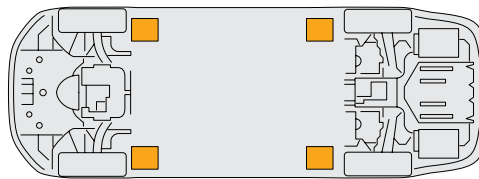
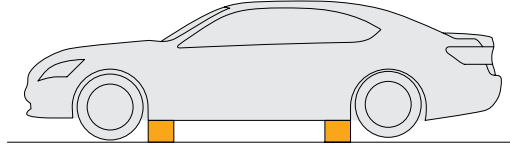

WARNING

- Do not place cribbing such as wooden blocks or rescue air lifting bags under the exhaust system, fuel system or high voltage power cables. Failure to do so may cause heat generation, bursting of the air lifting bags, damage to the high voltage power cables or damage to the hydrogen piping, resulting in a vehicle fire, crushing accident, electrical shock or gas leak, possibly leading to serious injury or death.

Components Requiring Special Attention

- The construction and functions of components requiring special attention during emergency response are described in this section.



High Voltage System



WARNING

- The high voltage system may remain charged for up to 10 minutes after the vehicle is shut off and disabled (see page 14). Failure to shut off and disable the vehicle before emergency response procedures are performed may result in serious injury or death from severe burns and electric shock from the high voltage electrical system.
- When the person(s) in charge of handling the damaged vehicle is away from the vehicle, other person(s) may accidentally touch the vehicle and be electrocuted, resulting in death or serious injury. To avoid this danger, display a “HIGH VOLTAGE DO NOT TOUCH” sign to warn others (print and use page 14 of this guide).
- The high voltage battery may be charged even when the vehicle is stopped. To stop the high voltage battery from charging, remove the negative (-) terminal of the 12 V battery.
- To prevent electric shock, after disconnecting the high voltage connector, wait for at least 10 minutes before touching any of the high-voltage connectors or terminals.



High Voltage Power Cable

- High voltage power cables are indicated by an orange colour and are used to connect high voltage electrical components such as the high voltage battery inverter/converter, electric motor, A/C compressor and charger.
- The high voltage power cables are installed in the engine/motor compartment and in the centre of the vehicle (routed through the centre tunnel) or on either side away from the rocker panels.
- Also, high voltage cables are used in the plug-in charging system (see page 40) and the solar charging system (see page 48).

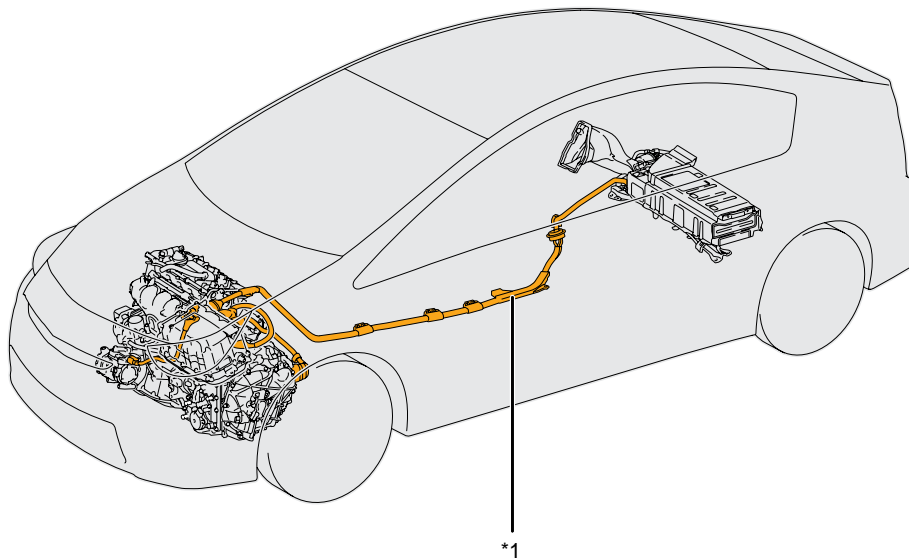

*1	High Voltage Power Cable
----	--------------------------



Inverter/Converter

- The inverter/converter installed in the engine/motor compartment boosts and inverts the DC electricity from the high voltage battery to AC electricity that drives the electric motor.
- The inverter/converter of fuel cell vehicles (FCEV) also supplies an electric current converted to AC to the FC air compressor.

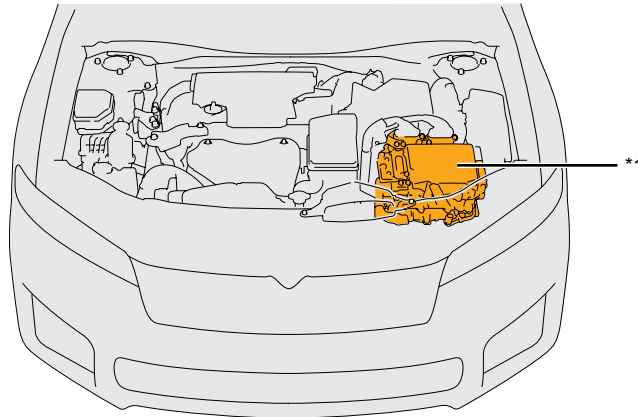

*1	Inverter/Converter
----	--------------------

DC/DC Converter

- The DC/DC converter lowers the DC electricity from the high voltage battery to supply it to electric accessories such as the headlights and power windows, and to charge the 12 V battery.
- The DC/DC converter is built into the inverter/converter or installed in the area near the high voltage battery on some models.

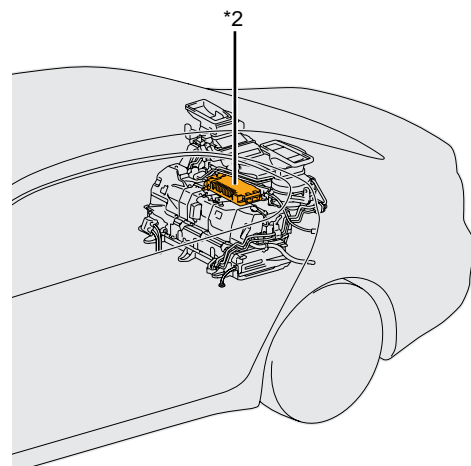
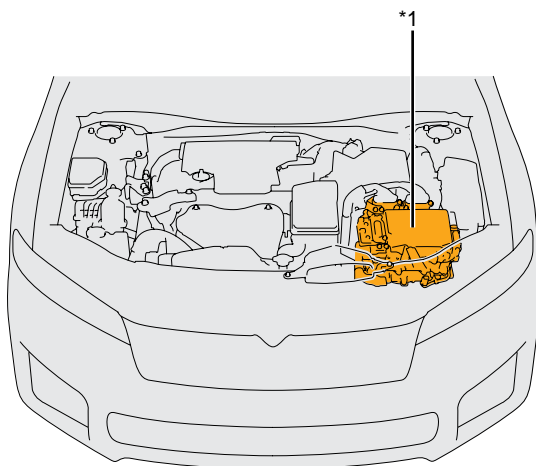

*1	DC/DC Converter (Built into Inverter/Converter)
----	---

*2	DC/DC Converter
----	-----------------



HEV/BEV/FCEV Transmission HEV/BEV/FCEV Transaxle

- The HEV/BEV/FCEV transmission/transaxle contains an electric motor/generator that is powered by output voltage (up to 650 V) from the inverter/converter, and charges the high voltage battery.
- The HEV/BEV/FCEV transmission/transaxle is installed in the engine compartment or motor compartment. Location varies depending on layout.

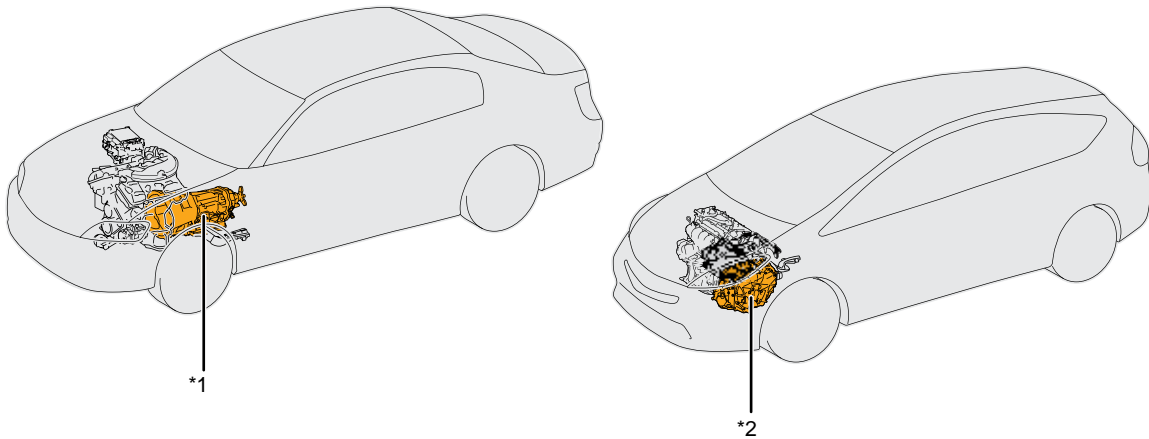

*1	HEV/BEV/FCEV Transmission	*2	HEV/BEV/FCEV Transaxle
----	---------------------------	----	------------------------

Rear Drive Motor

- The rear drive motor is powered by output voltage (up to 650 V) from the inverter/converter.
- It is built into the rear transaxle and located above the rear driveshafts.

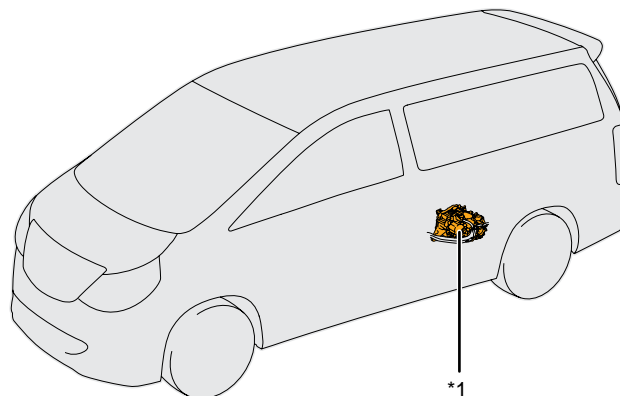

*1	Rear Transaxle (Rear Drive Motor)
----	-----------------------------------



A/C Compressor

- The A/C compressor used on hybrid vehicles (HEV), electric vehicles (BEV) and fuel cell vehicles (FCEV) contains an electric motor that is powered by electricity from the high voltage battery. It is installed in the engine/motor compartment.

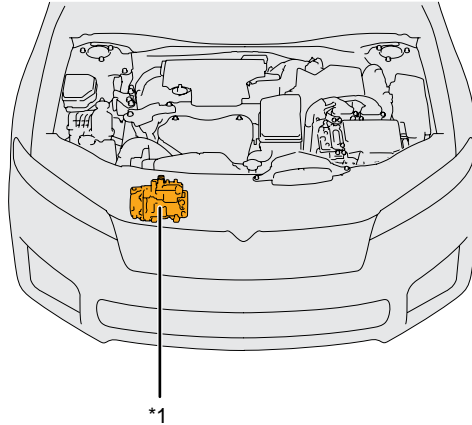

*1	A/C Compressor
----	----------------

Coolant Heater

- Fuel cell vehicles (FCEV) is equipped with a coolant heater to heat the coolant, installed inside the motor compartment.
- The coolant heater is operated using the power from the high voltage battery.

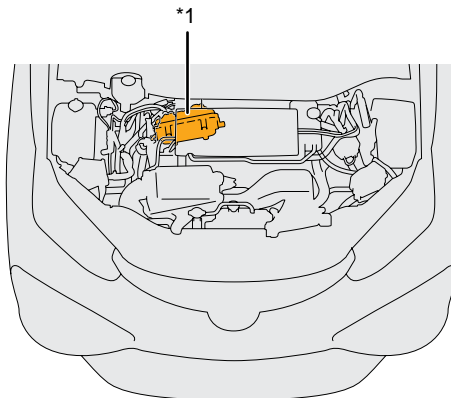

*1	Coolant Heater
----	----------------



Plug-in Charging System

- Plug-in hybrid vehicles (PHEV) and electric vehicles (BEV) are equipped with a plug-in charging system in order to charge the high voltage battery from an external power source.
- The plug-in charging system is mainly comprised of an onboard charger and charging inlet.
- The onboard charger converts the AC supplied from an external power source to DC, boosts it, and then uses it to charge the high voltage battery.
- The charger inlet receives the charge to the high voltage battery from an external power source. Also, some electric vehicles have a separate fast charging inlet which can be used at fast chargers (DC 500 V).
- The orange power cables are connected to the charging inlet, which is supplied high voltage during charging.

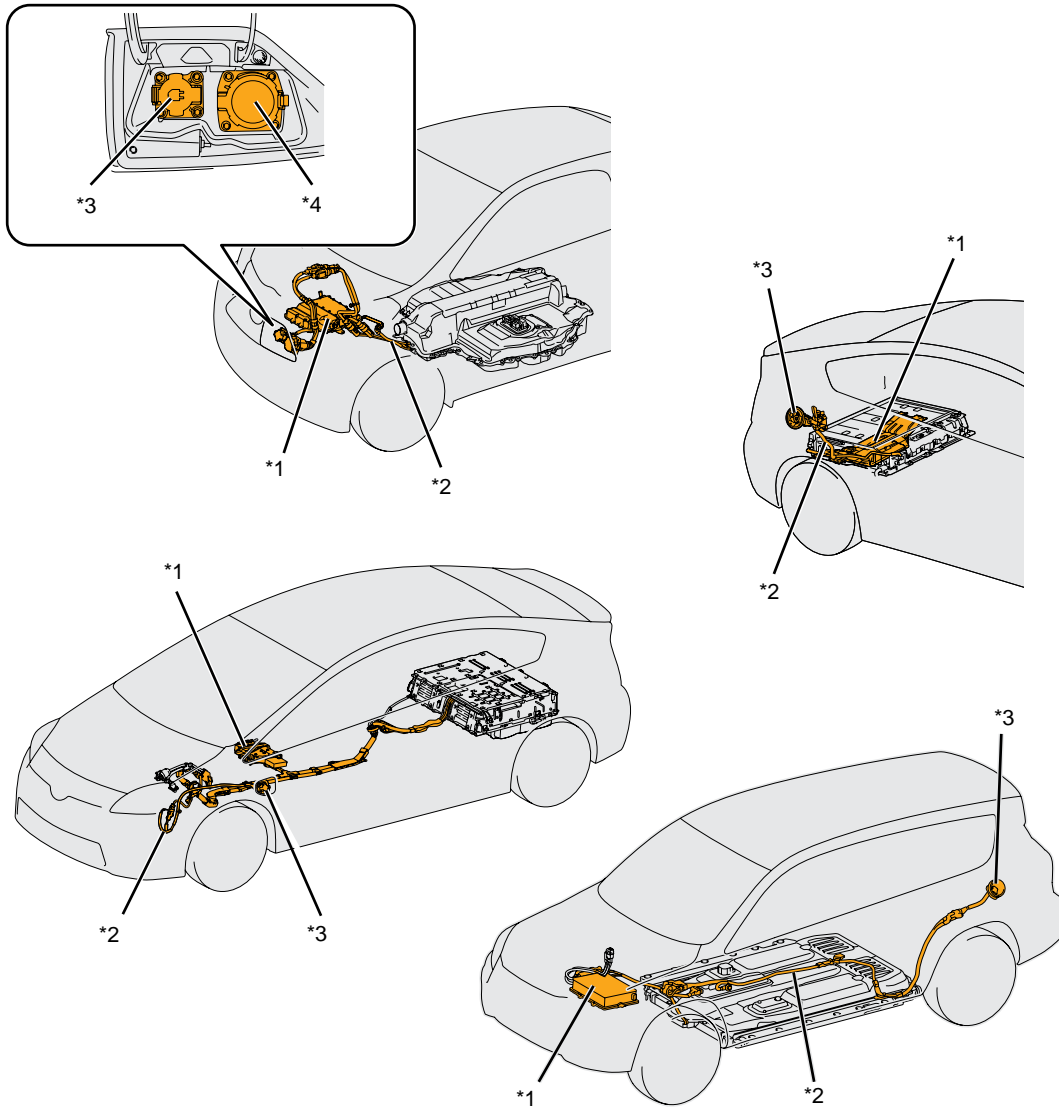

*1	Onboard Charger	*2	High Voltage Power Cable
*3	Charging Inlet	*4	Fast Charging Inlet



■ To prevent serious injury or death from severe burns or electric shock, shut off the utility circuit supplying power to the charge cable before disconnecting it if the vehicle, charge cable or charger is submerged in water.



NOTICE

- Some plug-in hybrid vehicles and electric vehicles have a connector locking system. The charging connector is unlocked by pressing the charging connector lock switch after unlocking the doors.

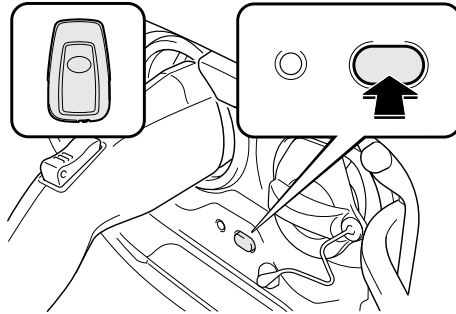

- If the lock of the charge cable assembly connector cannot be released, turn OFF or unplug the external charger, or turn its main breaker OFF.

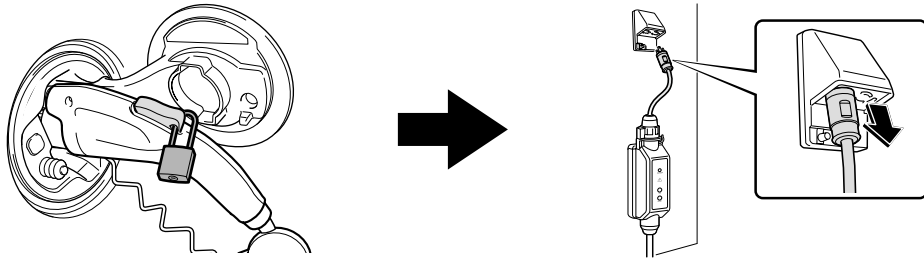

- The lock of the charge cable assembly connector cannot be released during fast charging. If charging does not stop even when the charger is turned OFF, turn its main breaker OFF.



Accessory Socket (AC220V / 1500W, AC220V / 2400W)

- Hybrid electric vehicles (HEV), plug-in hybrid electric vehicles (PHEV), fuel cell electric vehicles (FCEV) and battery electric vehicles (BEV) are equipped with an accessory socket that supplies power to electric devices compatible with output voltage/output power: AC220V / 1500W, AC220V / 2400W.
- It converts the voltage from the high voltage battery with a dedicated voltage inverter, separate from the high voltage inverter or converter, and supplies power to the accessory socket.
- The voltage inverter is connected with an orange high voltage cable, and high voltage current flows through it when the high voltage system is running.

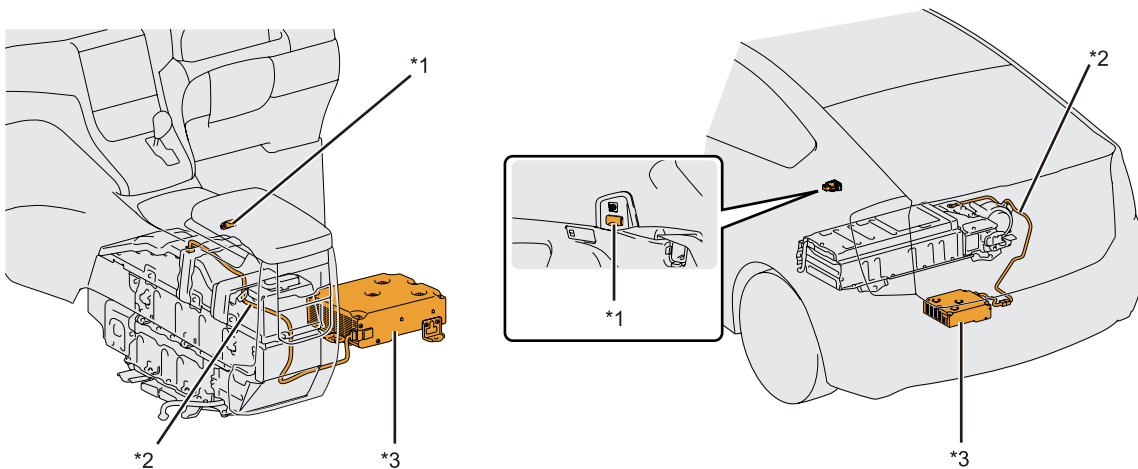

*1	Accessory Socket	*2	High Voltage Power Cable
*3	Voltage Inverter	-	-



ESU (Electricity Supply Unit)

- An ESU (Electricity Supply Unit) is used which packages the power converter necessary for electric vehicles, and the components traditionally built into the high voltage battery (high voltage junction box, DC relay) into one unit.
- A 2 layer construction is used with the upper layer containing the high voltage junction box, charging inverter ECU and DC relay, and the lower layer containing the DC/DC converter and AC charger.

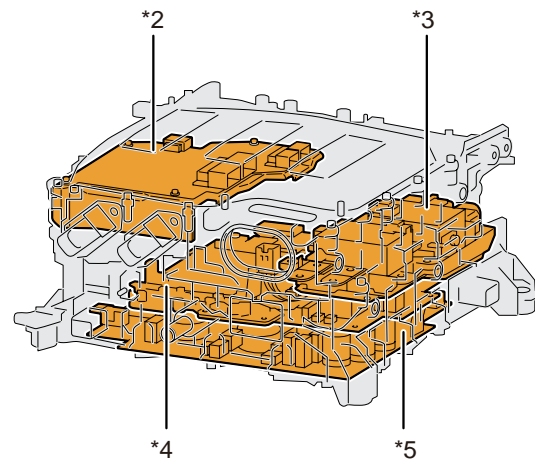
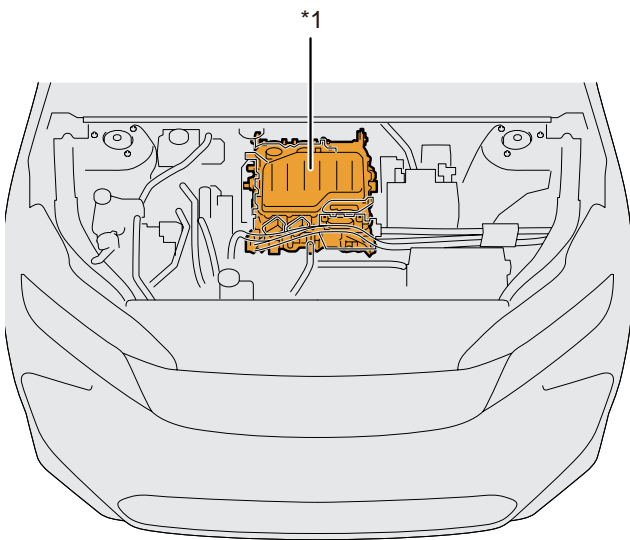

*1	ESU (Electricity Supply Unit)	*2	Charging Inverter ECU
*3	DC Relay	*4	DC/DC Converter
*5	AC Charger		

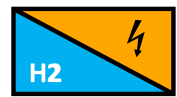

Fuel Cell (FC) System



WARNING

- If the sound of hydrogen leaking (a loud hissing sound) can be heard when working on the vehicle, or if the hydrogen concentration around the vehicle exceeds 1% when measured with a hydrogen concentration detector, immediately step away from the vehicle as there is a chance that the hydrogen gas may ignite.
- Even after the vehicle is stopped (see page 57), hydrogen remains inside the FC stack, hydrogen tanks and other hydrogen-related parts, as well as inside the hydrogen pipe. In order to avoid fires and explosions, never cut or damage these hydrogen-related parts or the hydrogen pipe.
- When the person(s) in charge of handling the damaged vehicle are away from the vehicle and someone else accidentally approaches or touches the vehicle, death or serious injury may occur due to electrocution, a rupture, an explosion or fire. To avoid this danger, display “HIGH VOLTAGE DO NOT TOUCH” and “HIGH-PRESSURE GAS DO NOT TOUCH” signs to warn others (print and use page 14 and 16 of this guide).

FC Water Pump and Hydrogen Pump Inverter

- The FC water pump and hydrogen pump inverter converts DC from the high voltage battery to AC, and supplies this current to the hydrogen pump and FC water pump.
- The FC water pump and hydrogen pump inverter is installed in the motor compartment.

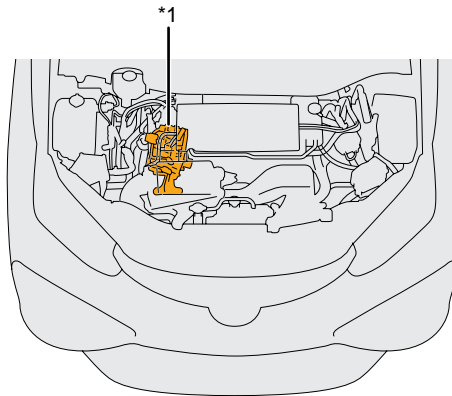

*1	FC Water Pump and Hydrogen Pump Inverter
----	--

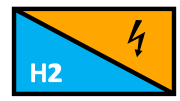

FC Boost Converter

- The FC boost converter increases the voltage of DC generated by the FC stack to a maximum of 650 V for motor operation, and then supplies this current to the inverter/converter.
- The FC boost converter is installed in the centre tunnel (outside the cabin).

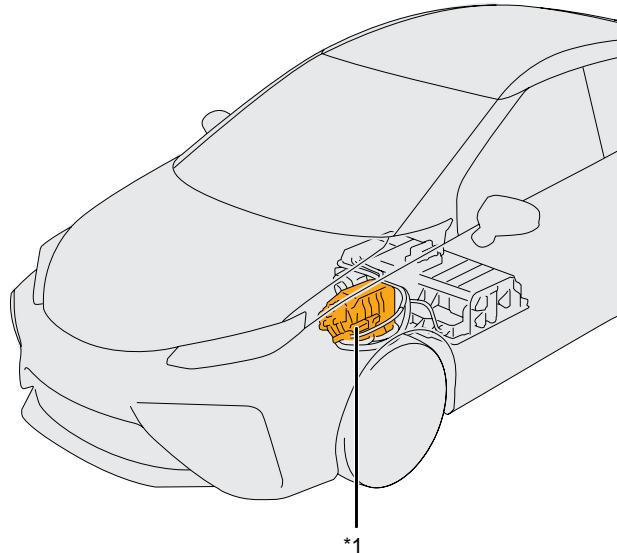

*1 FC Boost Converter

FC Air Compressor

- The FC air compressor supplies air (oxygen) to the FC stack.
- The FC air compressor has a built-in motor which is driven using the output voltage from the inverter/converter (up to 650 V), and is installed in the motor compartment.

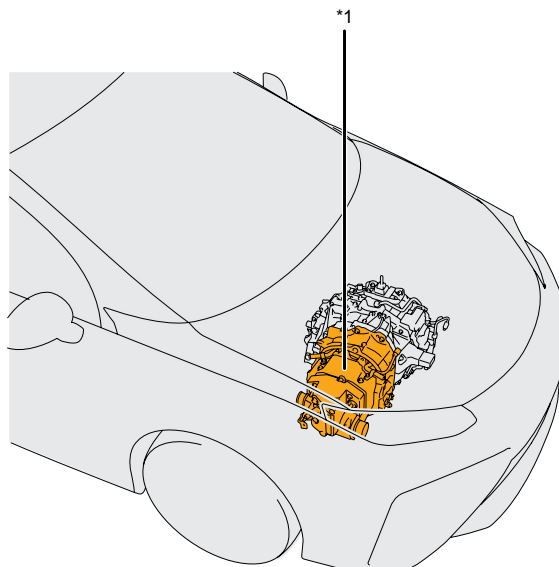

*1 FC Air Compressor

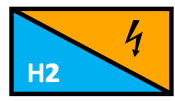

FC Water Pump

- The FC water pump circulates the coolant to cool the FC stack.
- The FC water pump has a built-in motor which is driven using the high voltage from the FC water pump and hydrogen pump inverter, and is installed in the motor compartment.

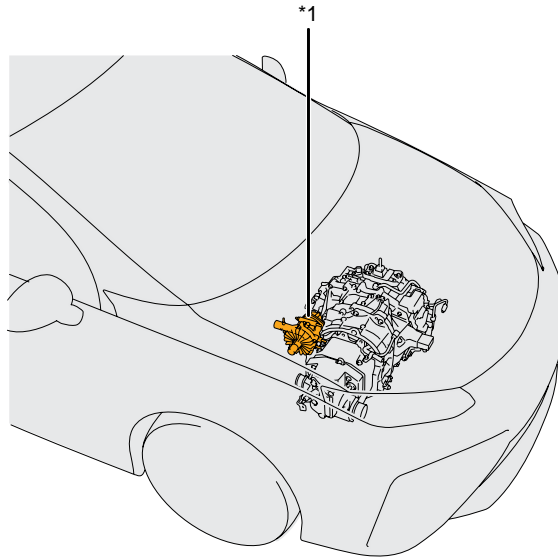

*1 FC Water Pump

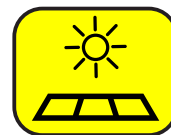

Solar Charging System

1st generation solar charging system

- The solar charging system uses a solar roof with an integrated solar cell to generate photovoltaic power which is then used to charge the high voltage battery according to the vehicle condition while parked and to compensate for the consumption of the 12 V battery system while the vehicle is being driven. In addition, the solar charging system charges and discharges the solar battery during this process.
- The solar charging system consists of a solar roof, a solar battery, a solar energy control unit, a high voltage battery and a 12 V battery.
- The orange high voltage power cable is connected between the solar energy control unit and high voltage battery. High voltage is applied when the high voltage battery is charging.
- The solar energy control unit has 3 built-in DC-DC converters: for the high voltage battery, solar battery and auxiliary system.
- An Ni-MH battery is used for the solar battery.
 1. The Ni-MH battery consists of 3 modules, each consisting of six 1.2 V cells, connected in series to obtain 21.6 V.
 2. The Ni-MH battery contains a strong alkaline electrolyte (pH 13.5). The electrolyte, however, is absorbed in the cell plates and will not normally spill or leak out even if a battery module is cracked.
 3. Electrolyte leakage from the solar battery is unlikely due to its construction and the amount of available electrolyte contained within the Ni-MH modules. Any spillage would not warrant a declaration as a hazardous material incident.
- The high voltage battery is not charged except for when the power switch is off.
- Depending on conditions such as solar radiation and temperature, the solar roof can reach a maximum voltage of approximately 50 V.
- Refer to the Rescue Sheet for each model for the locations of the high voltage electrical components.

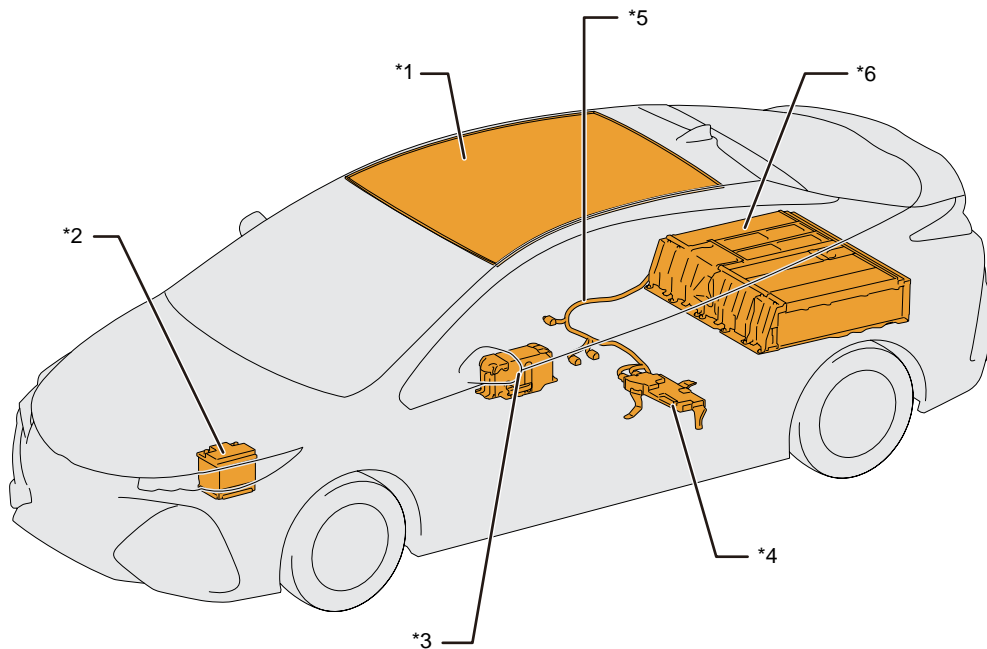

*1	Solar Roof	*2	12 V Battery	*3	Solar Battery
*4	Solar Energy Control Unit	*5	High Voltage Power Cable	*6	High Voltage Battery



WARNING

- The high voltage system may maintain the voltage even when the vehicle is stopped (see page 57) due to the solar charging system. If the high voltage system is not stopped, the high voltage may lead to severe burns or electric shock and may result in death or serious injury.
- To prevent death or serious injury from severe burns or electric shock, avoid touching, cutting, or breaching any orange high voltage power cable or high voltage component. Wear appropriate protective equipment such as insulated gloves when there is a risk of touching high voltage power cables or high voltage components.
- When the person(s) in charge of handling the damaged vehicle is away from the vehicle, other person(s) may accidentally touch the vehicle and be electrocuted, resulting in death or serious injury. To avoid this danger, display a "HIGH VOLTAGE DO NOT TOUCH" sign to warn others (print and use page 14 of this guide).
- The high voltage battery may be charged even when the vehicle is stopped. To stop the high voltage battery from charging, remove the negative (-) terminal of the 12 V battery.
- The solar roof generates electricity with even a small amount of sunlight. To stop generation of electricity, cover the solar roof completely with a material that will block sunlight.
- Strong alkaline electrolyte (pH 13.5) is harmful to the human body. To avoid injury by coming in contact with the electrolyte, wear appropriate protective equipment such as rubber gloves and safety goggles when there is a risk of touching electrolyte.



2nd generation solar charging system

- The solar charging system uses a solar roof with an integrated solar cell to generate photovoltaic power which is then used to charge the high voltage battery according to the vehicle condition while parked and to compensate for the consumption of the 12 V battery system while the vehicle is being driven. In addition, the solar charging system charges and discharges the solar battery during this process.
- The solar charging system consists of a solar roof, a solar battery, a solar energy control unit, a high voltage battery and a 12 V battery.
- The orange high voltage power cable is connected between the solar energy control unit and high voltage battery. High voltage is applied when the high voltage battery is charging.
- The solar energy control unit has 3 built-in DC-DC converters: for the high voltage battery, solar battery and auxiliary system.
- A 15 A fuse is used to prevent a dangerous situation even if there is a large flow of current.
- The high voltage battery is not charged except for when the power switch is off.
- Depending on conditions such as solar radiation and temperature, the solar roof can reach a maximum voltage of approximately 50 V.
- Refer to the Rescue Sheet for each model for the locations of the high voltage electrical components.

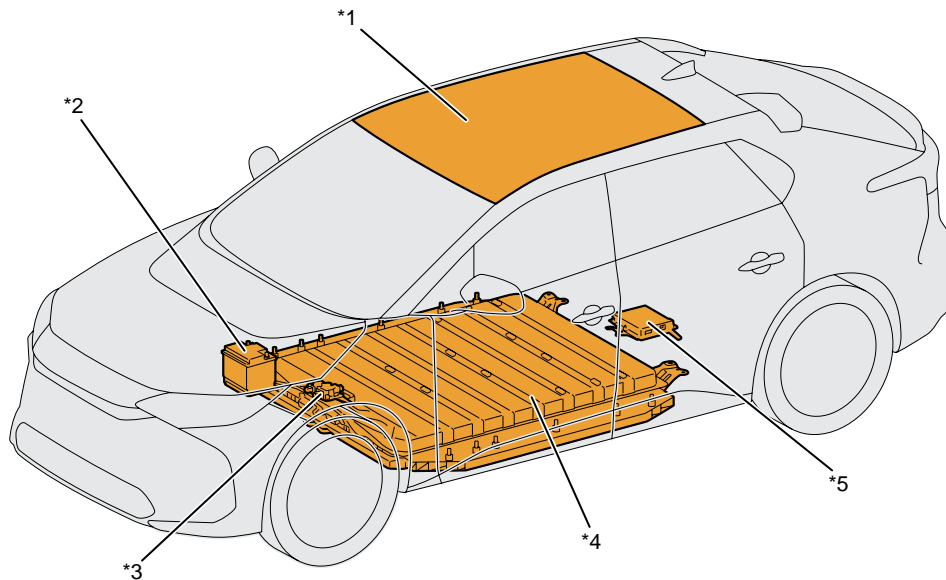

*1	Solar Roof	*2	12 V Battery	*3	High Voltage Junction Box
*4	High Voltage Battery	*5	Solar Energy Control Unit		



WARNING

- The high voltage system may maintain the voltage even when the vehicle is stopped (see page 57) due to the solar charging system. If the high voltage system is not stopped, the high voltage may lead to severe burns or electric shock and may result in death or serious injury.
- To prevent death or serious injury from severe burns or electric shock, avoid touching, cutting, or breaching any orange high voltage power cable or high voltage component. Wear appropriate protective equipment such as insulated gloves when there is a risk of touching high voltage power cables or high voltage components.
- When the person(s) in charge of handling the damaged vehicle is away from the vehicle, other person(s) may accidentally touch the vehicle and be electrocuted, resulting in death or serious injury. To avoid this danger, display a “HIGH VOLTAGE DO NOT TOUCH” sign to warn others (print and use page 14 of this guide).
- The high voltage battery may be charged even when the vehicle is stopped. To stop the high voltage battery from charging, remove the negative (-) terminal of the 12 V battery.
- The solar roof generates electricity with even a small amount of sunlight. To stop generation of electricity, cover the solar roof completely with a material that will block sunlight.

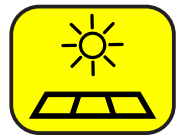

Solar Powered Ventilation System

- The solar powered ventilation system uses solar panels on the vehicle roof to generate up to 27 V of electricity. This electricity is used to power an electric fan which ventilates the cabin while the vehicle is parked in the hot sun.

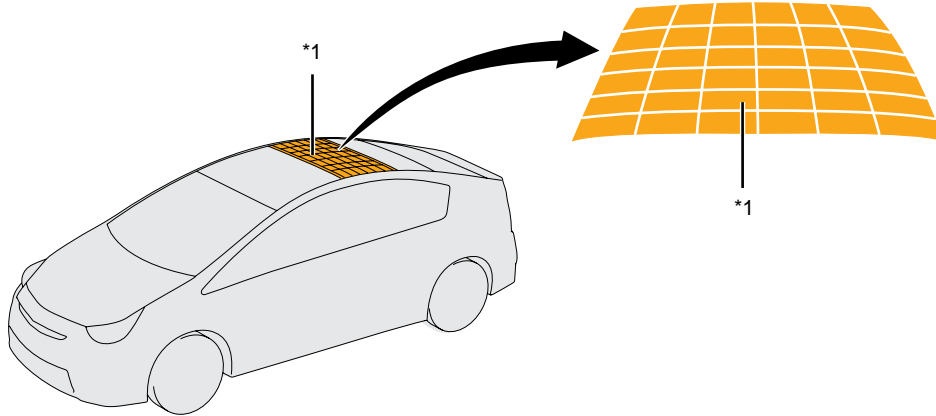

*1 Solar Panels



WARNING

- The solar panels generate electricity with even a small amount of sunlight. To stop generation of electricity, cover the solar panels completely with a material that will block sunlight.



Cable cut

- The vehicle is equipped with a cable cut which enables the high-voltage isolation procedure to be performed quickly and safely.
- A sticker is attached to the cable cut for easy identification.
- For the detailed installation location, refer to the Rescue Sheet for the respective vehicle.

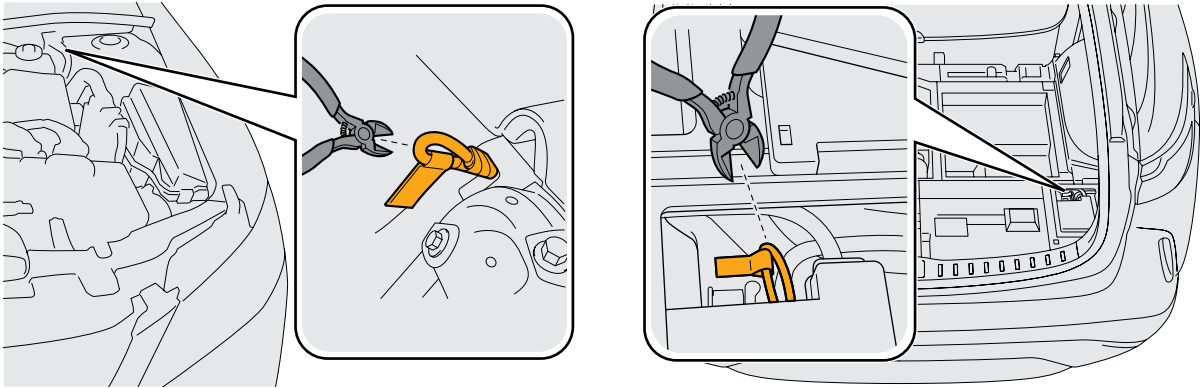

Low voltage device that disconnects high voltage

- The vehicle is equipped with a service plug which enables the high-voltage isolation procedure to be performed safely during inspection and maintenance.
- Refer to the rescue sheet for the detailed location for each vehicle.

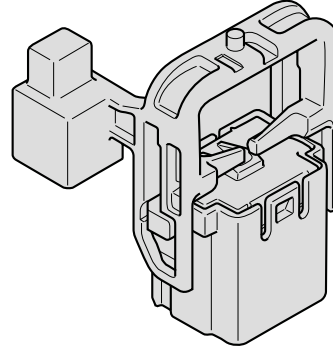
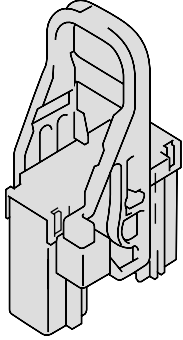

Interlock Connector

- Some vehicles are equipped with an interlock plug to safely perform high voltage shutdown operation during service maintenance.

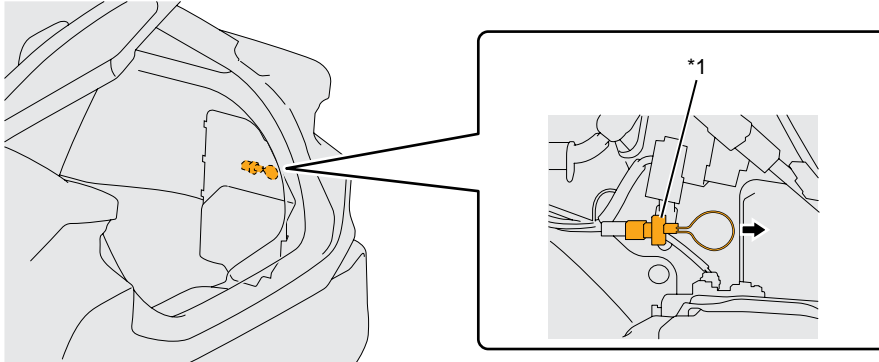

*1 Interlock Connector

Emergency Response Key Points

- Procedures and points to be noted when handling TOYOTA vehicles during emergency response are provided in this section.
- Refer to the Rescue Sheet for each model for model specific information such as vehicle identification points, component locations, etc.

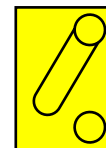

Disable Vehicle

- To ensure safe emergency response operations, the vehicle must be completely turned off by shutting off the power from the fuel pump, SRS airbag, high voltage battery, plug-in charging system, etc.
- Confirm the vehicle status. **If any of the following conditions exist**, the vehicle may not shut off.

- Engine is running.
- Ignition switch is in ACC, ON or START position.
- Meters are illuminated.
- Air conditioning is operating.
- Audio system is operating.
- Wipers are operating.
- Navigation or other displays are turned on.
- Charge cable is connected.



WARNING

- NEVER assume the vehicle is shut off simply because it is silent. If the vehicle is equipped with an idling stop system, or the vehicle is a hybrid vehicle (HEV) or plug-in hybrid vehicle (PHEV), the engine is silent while the vehicle is on. Make sure none of the above conditions exist.
- Failure to shut off and disable the vehicle before emergency response procedures are performed may result in serious injury or death from unintentional deployment of the SRS airbags or unintentional actuation of the seat belt pretensioners, pedestrian protection active system, or active headrests.

- When the vehicle is operating, carefully perform one of the procedures from 1 to 4 to disable the vehicle.

Procedure 1

1. Turn the ignition switch to the LOCK (OFF) position or push the engine/power switch once to shut off the vehicle.

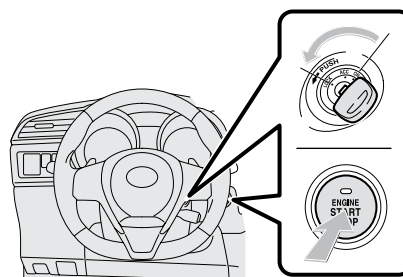

WARNING

- If the vehicle is equipped with an engine/power switch the vehicle is shut off when **ALL of the following conditions are met**. With all of the following conditions met, do not push the engine/power switch as the vehicle will start.
 - Engine is not running.
 - Meters are not illuminated.
 - Air conditioning is not operating.
 - Audio system is not operating.
 - Wipers are not operating.
 - Navigation and other displays are turned off.
 - Charge cable is disconnected.

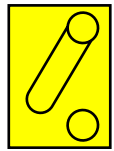

NOTICE

- The engine/power switch operates as follows.
With the brake pedal (for automatic vehicles) or the clutch pedal (for manual vehicles) depressed:
Vehicle Start → Stop → Start ... is repeated every time the switch is pushed.
- With the brake pedal (for automatic vehicles) or the clutch pedal (for manual vehicles) released:
Accessory → Ignition-On → Off → Accessory... is repeated.
- When in "Accessory" mode, the radio and other accessory components are operational.
- When in "Ignition-On" mode, the power windows, wipers, heater/air conditioner fan and other components including SRS system are operational.
- The vehicle will not start if the brake pedal (for automatic vehicles) or the clutch pedal (for manual vehicles) is not depressed, even if the switch is pushed.

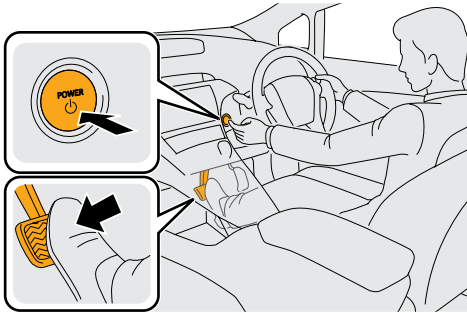

*A

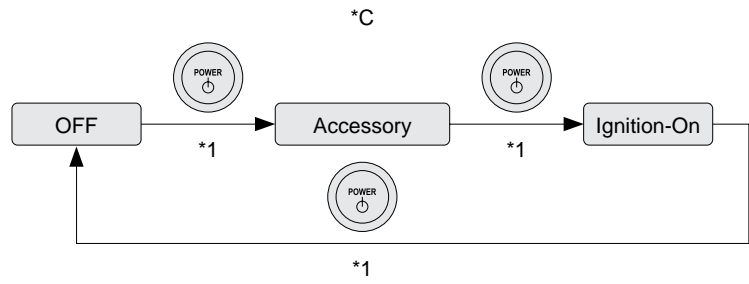

*B

*A	Brake Pedal Depressed	*B	Brake Pedal Released	*C	Ignition Mode Sequence
*1	Switch Push				

2. When the vehicle is equipped with an engine/power switch, keep the electrical key transmitter 5 meters (16.4 feet) or more away from the vehicle.



NOTICE

- If the electrical key transmitter is in the cabin or near the vehicle, the vehicle may start depending on what operations are performed. For example, if the engine/power switch is pushed.
- To prevent unexpected starting of the vehicle, place the electrical key transmitter outside of the detection area.

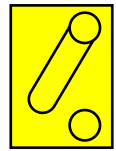

3. Disconnect the negative (-) terminal of the 12 V battery.

- The 12 V battery is installed in the engine compartment, in the luggage compartment or under the rear seat.
- Refer to the Rescue Sheet for each model for the location of the 12 V battery.

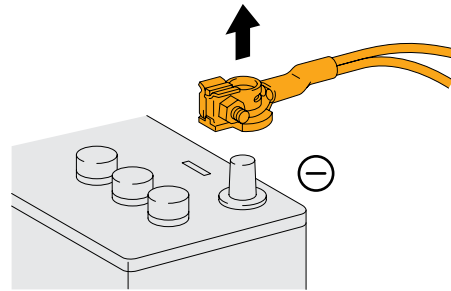

NOTICE

- Shut off the power to the electrical system to prevent electrical fires and to keep the vehicle from starting.
- After the negative (-) terminal of the 12 V battery has been disconnected and the power has been shut off, approximately 12 V is maintained between the positive (+) terminal and negative (-) terminal of the sub-battery for up to approximately 10 minutes.

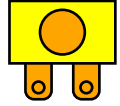

Procedure 2 Remove the appropriate fuse (Alternate if the ignition switch or power switch is inoperative)

1. Open the bonnet. Remove the engine room covers, if any are present.

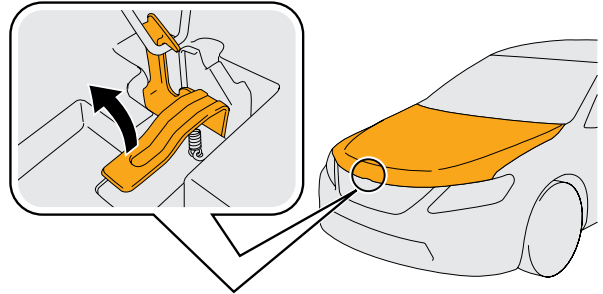

2. Remove the engine compartment fuse box cover.

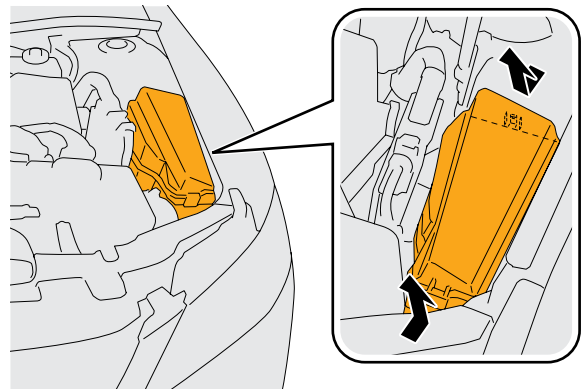

3. Remove the appropriate fuse.

- Refer to the Rescue Sheet for each model for the fuse to be removed.

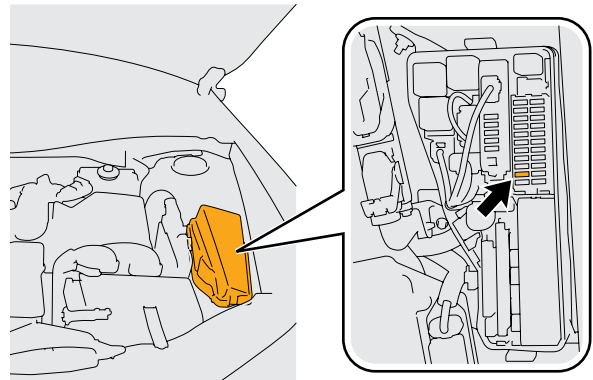

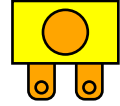

NOTICE

■ If the correct fuse cannot be identified, pull **ALL fuses in the fuse box until all of the following** conditions are met.

- Engine is not running.
- Meters are turned off.
- Air conditioning is turned off.
- Audio system is turned off.
- Wipers are turned off.
- Navigation and other displays are turned off.

4. Disconnect the negative (-) terminal of the 12 V battery.

- The 12 V battery is installed in the engine compartment, in the luggage compartment or under the rear seat.
- Refer to the Rescue Sheet for each model for the location of the 12 V battery.

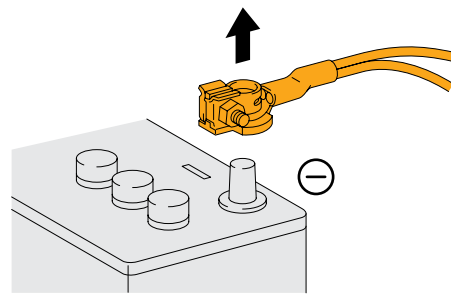

NOTICE

- Shut off the power to the electrical system to prevent electrical fires and to keep the vehicle from starting.
- After the negative (-) terminal of the 12 V battery has been disconnected and the power has been shut off, approximately 12 V is maintained between the positive (+) terminal and negative (-) terminal of the sub-battery for up to approximately 10 minutes.



Procedure 3 Disconnect the cable cut (Alternate if the ignition switch or power switch is inoperative)

1. Open the bonnet. Remove the engine room covers, if any are present.

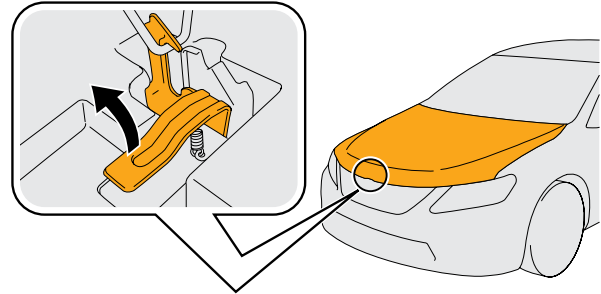

2. Disconnect the cable cut.

- For the installation location, refer to the Rescue Sheet for the respective vehicle.

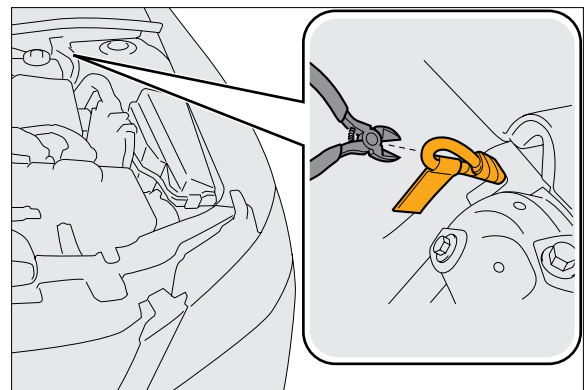

3. Disconnect the negative (-) terminal of the 12 V battery.

- The 12 V battery is installed in the engine compartment, in the luggage compartment or under the rear seat.
- Refer to the Rescue Sheet for each model for the location of the 12 V battery.

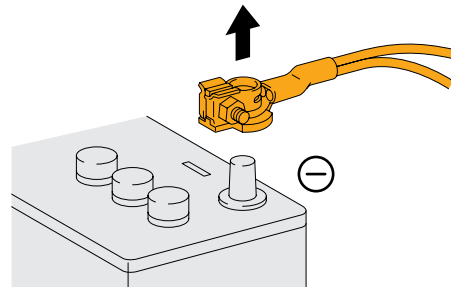



NOTICE

- Shut off the power to the electrical system to prevent electrical fires and to keep the vehicle from starting.
- After the negative (-) terminal of the 12 V battery has been disconnected and the power has been shut off, approximately 12 V is maintained between the positive (+) terminal and negative (-) terminal of the sub-battery for up to approximately 10 minutes.

Vehicle with High Voltage Battery

- Hybrid vehicles (HEV), plug-in hybrid vehicles (PHEV), electric vehicles (BEV) and fuel cell vehicles (FCEV) are equipped with a high voltage electrical system (120 to 800 V).



WARNING

- The high voltage system may remain charged for up to 10 minutes after the vehicle is shut off and disabled (see page 57). Failure to shut off and disable the vehicle before emergency response procedures are performed may result in serious injury or death from severe burns and electric shock from the high voltage electrical system.
- To prevent serious injury or death from severe burns or electric shock, avoid touching, cutting, or breaching any orange high voltage power cable or high voltage component. Wear appropriate protective equipment such as insulated gloves when there is a risk of touching high voltage power cables or high voltage components.
- NEVER assume the hybrid vehicle (HEV), plug-in hybrid vehicle (PHEV) or electric vehicle (BEV) is shut off simply because it is silent. Always observe the instrument cluster for the **READY** indicator status to verify whether the high voltage system is on or shut off. The high voltage system is shut off when the **READY** indicator is off.
- When the vehicle is equipped with a remote air conditioning system and the meters are illuminated, high voltage may be applied to the air conditioning system even though the **READY** indicator is off. Shut off and disable vehicle and ensure the meters are turned off.



Vehicle with Plug-in Charge System

- Plug-in hybrid vehicles (PHEV) and electric vehicles (BEV) are equipped with a system to charge the high voltage battery using power from an external power source.
- If a charge cable is connected to the charging inlet of the vehicle, disconnect the charge cable as follows to stop charging.

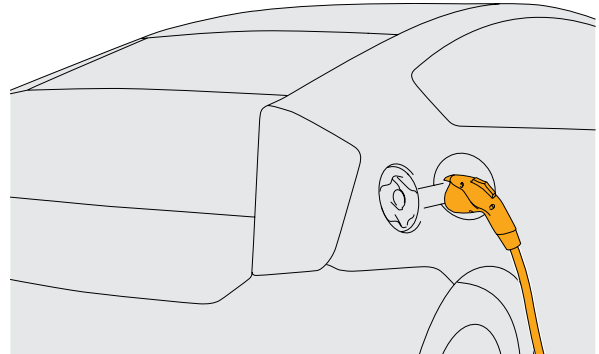

1. Push the latch release button on the top of the charging connector and pull it away from the charging inlet of the vehicle.

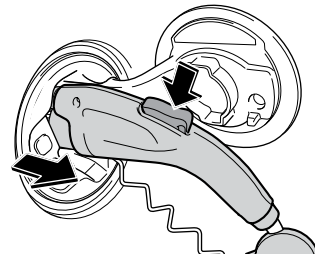

NOTICE

- Some plug-in hybrid vehicles and electric vehicles have a connector locking system. The charging connector is unlocked by pressing the charging connector lock switch after unlocking the doors.
- If the lock of the charge cable assembly connector cannot be released, turn OFF or unplug the external charger, or turn its main breaker OFF.
- The lock of the charge cable assembly connector cannot be released during fast charging. If charging does not stop even when the charger is turned OFF, turn its main breaker OFF.

2. Close the charging inlet cap and charging port lid.

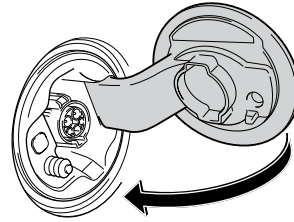

3. Turn off the external charger by unplugging it or turning its main circuit breaker off.

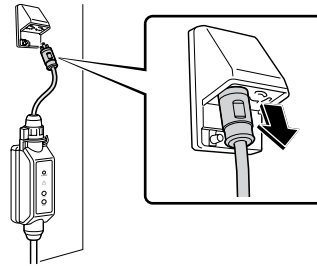

WARNING

- To prevent serious injury or death from severe burns or electric shock, shut off the utility circuit supplying power to the charge cable before disconnecting it if the vehicle, charge cable or external charger is submerged in water.

Vehicle with Hydrogen Gas

- Fuel cell vehicles (FCEV) carry compressed hydrogen gas. In order to abort refueling, follow the steps below.

1. Operate the hydrogen station to abort refueling.

- Hydrogen inside the hose will be depressurised and the filling nozzle can now be removed.

2. Remove the filling nozzle of the hydrogen station from the refueling port (receptacle).

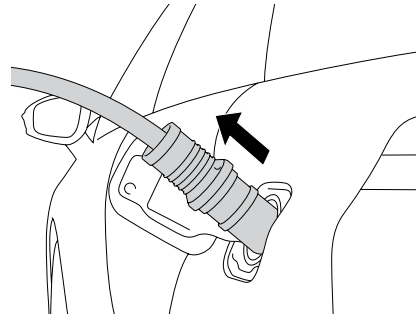

3. Put the cap on the refueling port (receptacle).

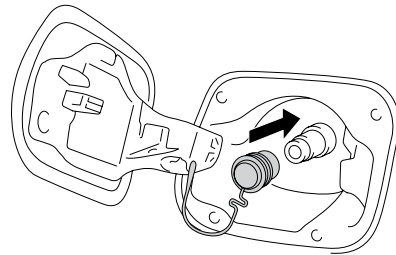

4. Close the fuel door.

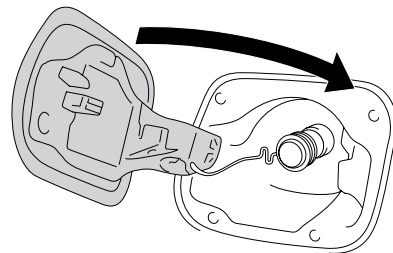

WARNING

- For fuel cell vehicles (FCEV), even if the READY indicator turns off, the high voltage system may still be active if the H₂O indicator in the combination meter is illuminated. Shut off and disable the vehicle and ensure the meters are turned off.

Components Requiring Special Attention

- The construction and functions of components requiring special attention during emergency response are described in this section.

Doors

- The door is opened by operating the handle on the door.
- Some vehicles are equipped with parts such as flush handles which are normally retracted and pulled to open the door, e-latch handles which contain a switch set inside the handle itself to open the door by pressing it, access doors (double doors) which are opened using the inner door handle, and back doors which are opened after lowering the back window glass.
- Refer to the rescue sheet for the door specifications of each vehicle.

Flush Handle Type

- When voltage is not supplied, such as when the terminal of the 12 V battery is disconnected, the flush handle will not be deployed electrically. In this case, the door handle must be opened manually.
 1. The retracted door handle can be pulled out by pushing on the front end.
 2. The door can be opened by pulling more on the pulled out door handle.

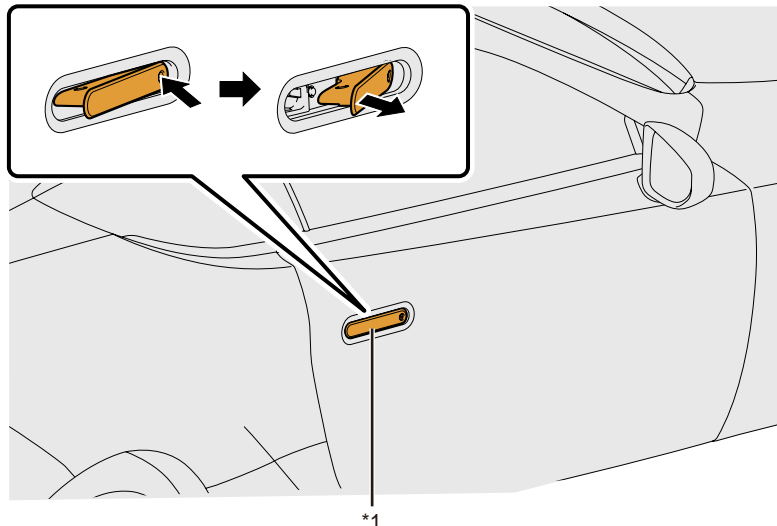

*1 Door Handle



NOTICE

- If the door lock is engaged, insert the mechanical key into the flush handle to release the lock.

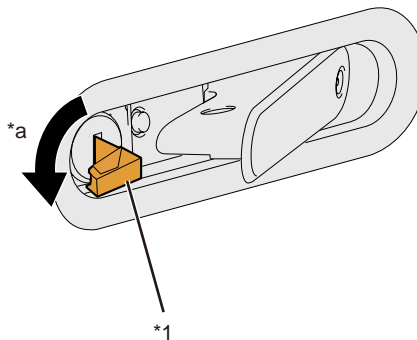

*1 Mechanical Key

*a Unlock

e-latch Handle

- When opening the door from outside the vehicle, the door is opened by gripping the outside handle while pressing the switch on the inside. When opening the door from inside the vehicle, the door is opened by pressing the switch on the inside handle.

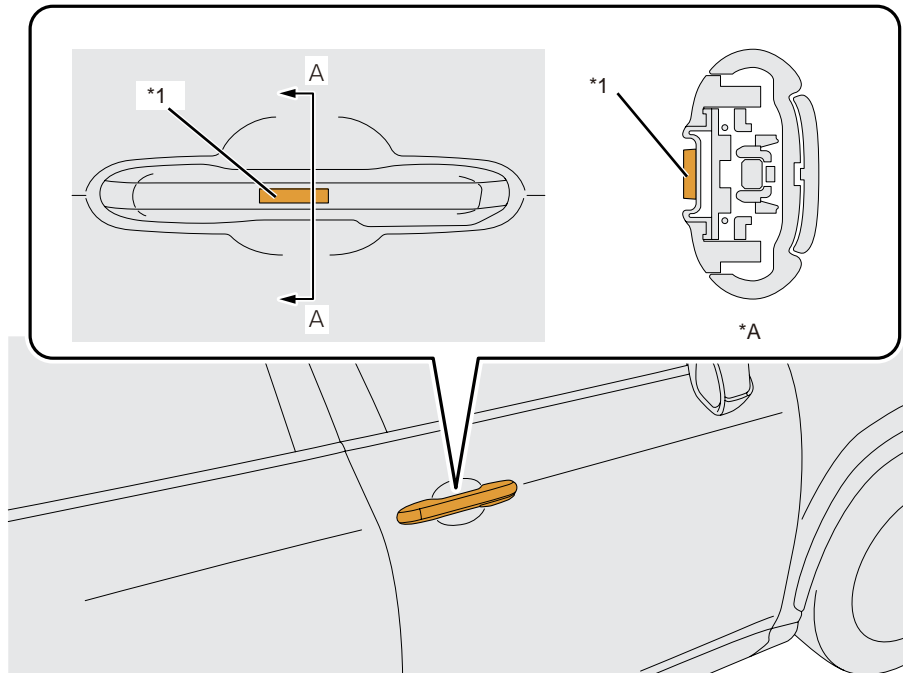

*A	A-A Cross Section
----	-------------------

*1	Switch
----	--------

Operations using the door opening switch will be disabled if battery voltage is not being supplied or if a collision occurs in which the airbag is deployed. In these types of situations, the manual release handle inside or outside the vehicle should be used to open the door. When opening the door from inside the vehicle, the door opening switch inside the vehicle will function as a manual release handle. The door is opened by pulling this manual release handle twice.

*A

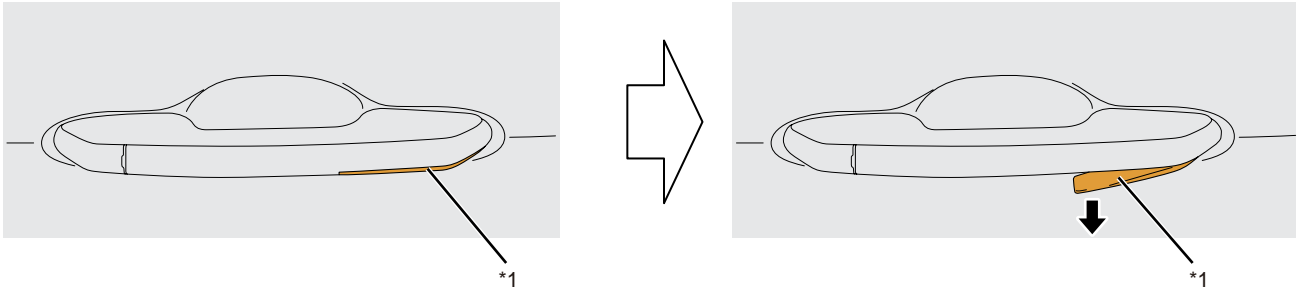

*B

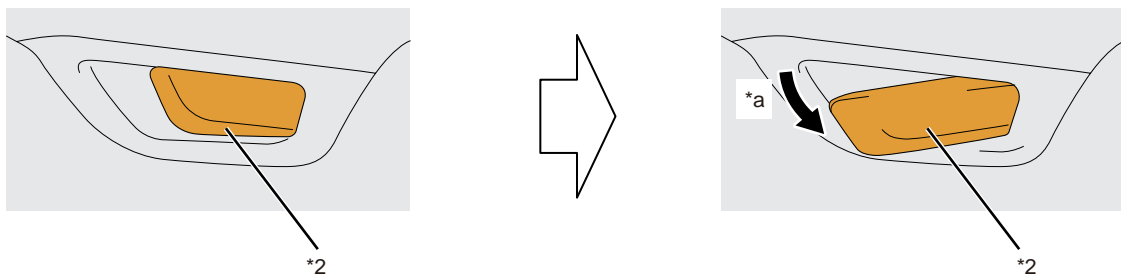

*A	Outside Release Handle	*B	Inside Release Handle
*1	Release Handle	*2	Release Handle (Door Opening Switch)
*a	Pull twice		



If the door is locked, use a plastic card or similar object to release the cover on the outside handle (toward the rear of the vehicle), insert the mechanical key into the key cylinder inside, and then turn toward the unlock side to enable the release handle outside the vehicle.

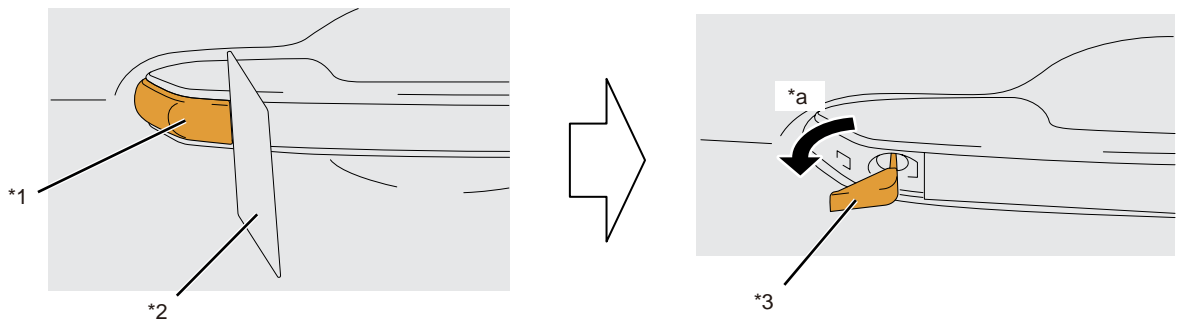

*1	Cover	*2	Card
*3	Mechanical Key	*a	Unlock Side

Door Open Switch

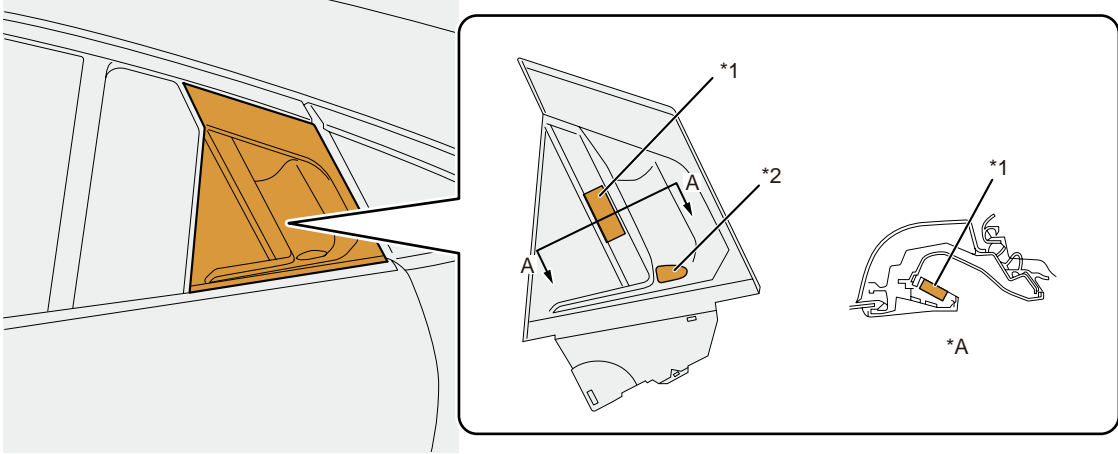

*A	A-A Cross Section		
*1	Switch	*2	Manual Operate Button

- When opening the door from outside the vehicle, the door can be opened by simultaneously pushing the inside switch while holding the outside handle.
- As operation of the internal switch of the outside handle is disabled when there is no voltage being supplied by the battery, or a collision occurs for which the airbags were deployed, etc., open the door using the manual operate button.

Access Door (Double door)

1. Open the front door as much as possible.
2. Pull the door handle on the access door forward.
3. Open the access door.

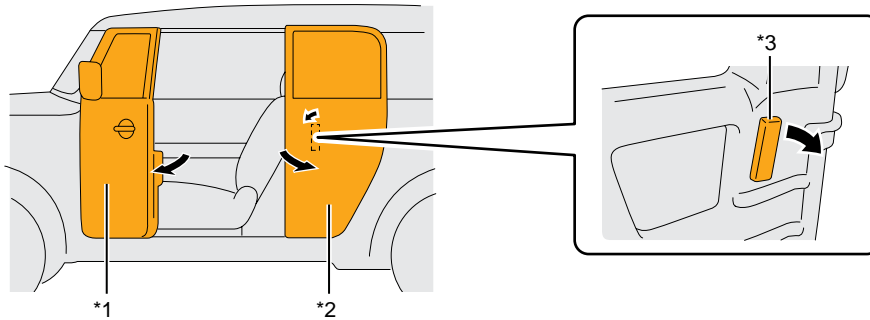

*1	Front Door	*2	Access Door
*3	Door Handle		



- Before opening either access doors, make sure the front seatbelt is unfastened. If the access door is opened with the front seatbelt fastened, the seatbelt may be locked and squeeze the front occupant, resulting in a serious injury.

Back Door

1. Insert a key into the key cylinder in the back door then turn the key clockwise to lower the back window glass.
2. Pull up the lock knob on the back door to release the lock.
3. Pull up the back door handle to open the back door.

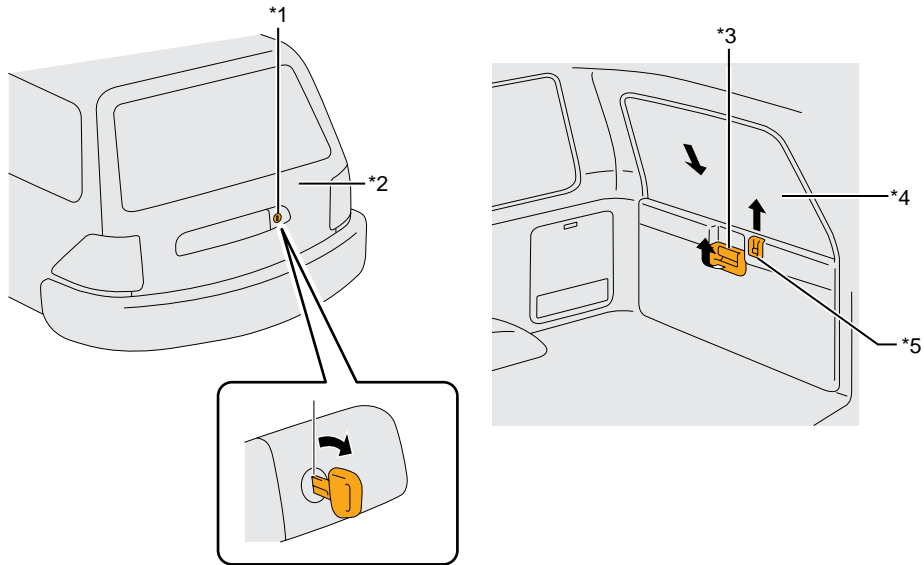

*1	Key Cylinder	*2	Back Door
*3	Back Door Handle	*4	Back Window Glass
*5	Lock Knob		

Structural Reinforcements

- A side impact protection beam and ultra high tensile strength sheet steel that are stronger than normal steel sheets are used as structural reinforcements.
- Refer to the Rescue Sheet for each model for locations of the side impact protection beams and ultra high tensile strength sheet steel.



NOTICE

- Because the strength of side impact protection beam and ultra high tensile strength sheet steel is higher than sheet steel and high tensile strength sheet steel, it is difficult to cut through side impact protection beam and ultra high tensile strength sheet steel with conventional cutters. Avoid side impact protection beam and parts made from ultra high tensile strength sheet steel when cutting a vehicle.

Side Impact Protection Beam

- Side impact protection beams are located inside the door.

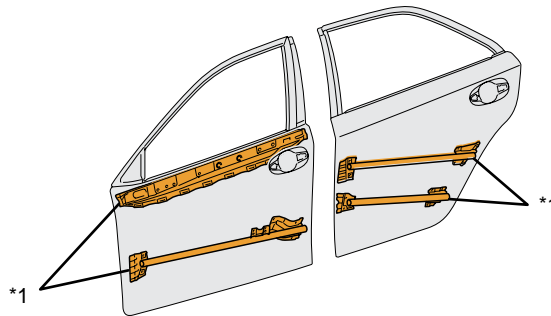

*1 Side Impact Protection Beam

Ultra High Tensile Strength Sheet

- Ultra high tensile strength sheet steel, which is approximately 1.5 times higher strength (1.5 GPa (15,296 kgf/cm², 217,557 psi) class) than standard high tensile strength sheet steel (under 1 GPa (10,197 kgf/cm², 145,038 psi) class), is used for some body structural components on certain models.

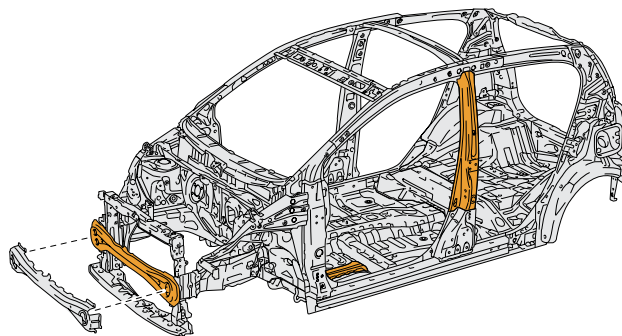

Ultra High Tensile Strength Sheet

- Refer to 4.Access to the occupants (P67) for the vehicle cutting procedure.

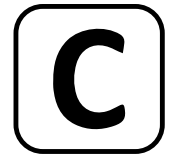

Carbon Fibre Reinforced Plastic (CFRP)

- Lightweight and highly rigid Carbon Fibre Reinforced Plastic (CFRP) is used for some body structural parts of certain models.
- CFRP can be cut and deformed using cutters for rescue operations.

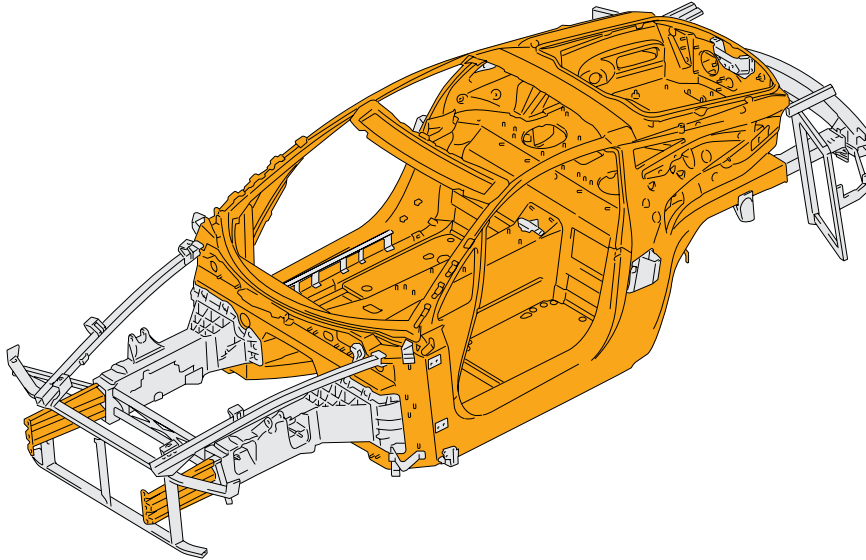

WARNING

- Cutting CFRP using a grinder or a saw will create carbon fibre dust. Wear appropriate protective equipment such as a dust mask and safety gloves when cutting CFRP.
- CFRP is conductive. If carbon fibre dust attaches to an electrical circuit, a short circuit may result. Keep electrical circuits free from carbon fibre dust when cutting CFRP.

Window Glass

- Laminated glass and tempered glass are widely used for vehicle windows.

* Laminated glass is mainly used for the windshield. It is also used for the door glass on some vehicles.

- Tempered glass is mainly used for the door glass, the roof glass and the back window glass.

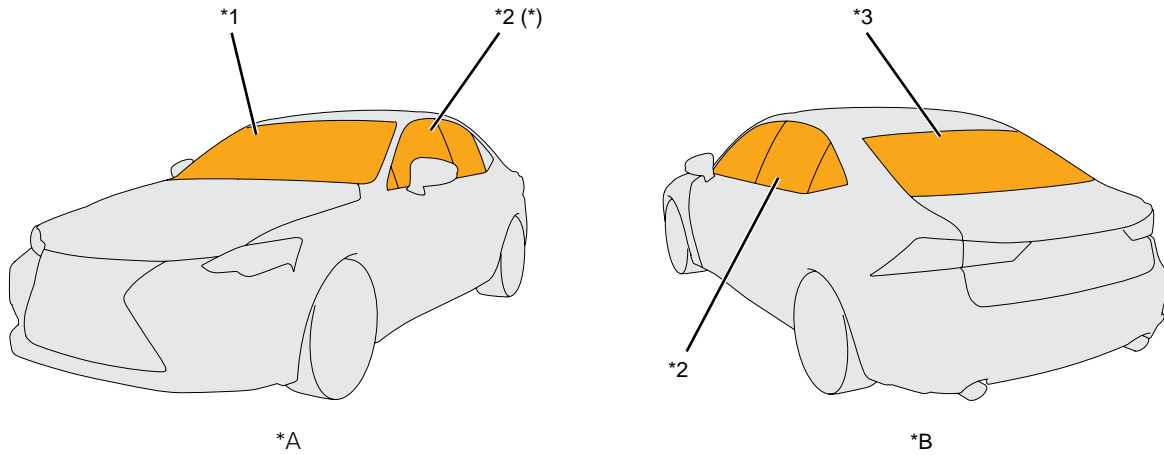

*A	Laminated Glass Applications	*B	Tempered Glass Applications
*1	Windshield	*2	Door Glass
		*3	Back Window Glass

- Laminated glass and tempered glass are indicated respectively by “LAMISAFE” or “TEMPERLITE” printed on glass.

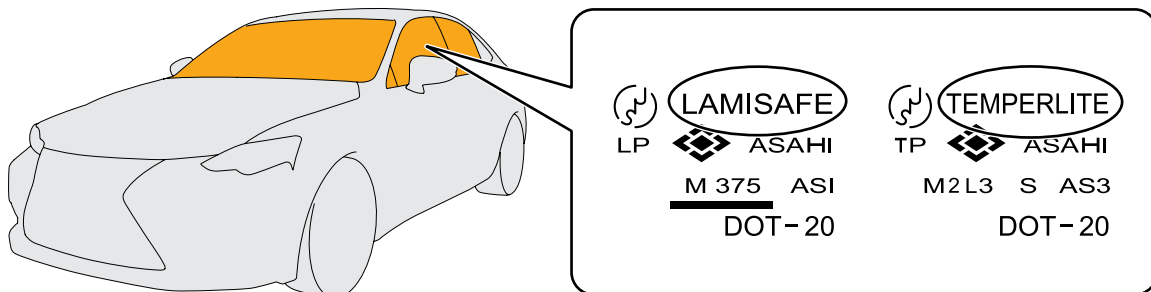

Laminated Glass

- Laminated glass consists of 2 layers of glass with a film in-between. Objects that strike the glass are less likely to penetrate the glass and glass shards tend to remain adhered to the film.

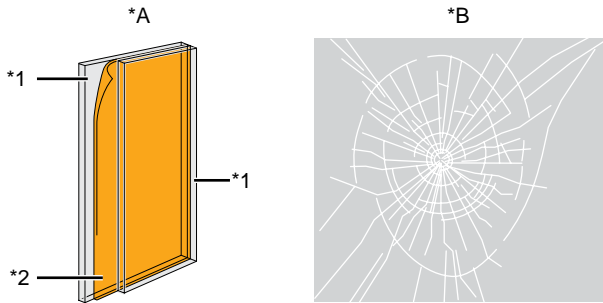

*A	LAMISAFE Structure
*B	Broken Laminated Glass
*1	Glass
*2	Film

Tempered Glass

- Tempered glass is heated to near softening temperature, then rapidly cooled down to make it 3 to 5 times stronger than normal glass. When tempered glass is broken, it will break into very small pieces.



NOTICE

- Laminated glass consists of 2 layers of glass bonded together with a film. It does not break easily even when struck by an object.

Front Seat

- Two types of front seats, a manual seat and a power seat, are available. When adjusting the seat position, a lever or a knob is operated for the manual seat and a switch is operated for the power seat.

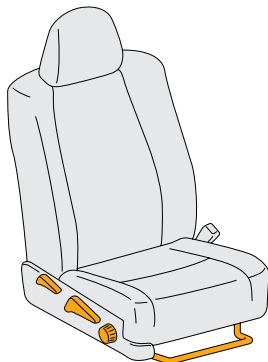

*1

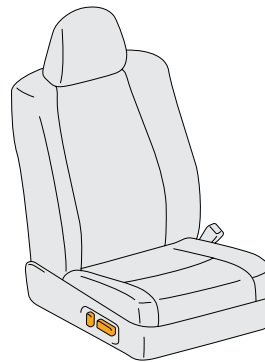

*2

*1	Manual Seat	*2	Power Seat
----	-------------	----	------------

Manual Seat

- The seat can be moved forward/backward by lifting the slide lever (slide adjustment).
- The seatback can be tilted forward/backward by lifting the reclining lever (reclining adjustment).
- The seat cushion can be raised/lowered by repeatedly pulling up/pushing down on the lever (lifter adjustment).
- The front end of the seat cushion can be raised/lowered by turning the vertical knob (front vertical adjustment).

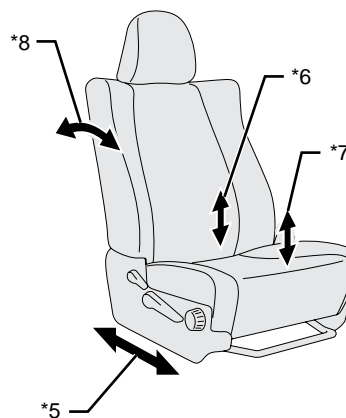
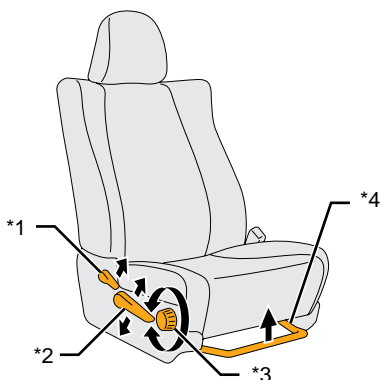

*1	Reclining Lever	*2	Lifter Lever
*3	Vertical Knob	*4	Slide Lever
*5	Slide Adjustment	*6	Lifter Adjustment
*7	Front Vertical Adjustment	*8	Reclining Adjustment

Power Seat

- The seat can be moved forward/backward using the slide function of the power seat switch (slide adjustment).
- The entire seat cushion can be raised/lowered using the lifter function of the power seat switch (lifter adjustment).
- The front end of the seat cushion can be raised/lowered using the front vertical function of the power seat switch (front vertical adjustment).
- The seatback can be tilted forward/backward by operating the reclining adjustment switch (reclining adjustment).
- The lumbar support position can be moved forward/backward by operating the lumbar support adjustment switch (lumbar support adjustment).
- The side support position can be moved right/left by operating the side support position adjustment switch (side support adjustment).
- The pelvic support position can be moved forward/backward by operating the pelvic support position adjustment switch (pelvic support adjustment).
- The shoulder support position can be moved forward/backward by operating the shoulder support position adjustment switch (shoulder support adjustment).
- The length of the seat cushion can be adjusted by operating the cushion length adjustment switch (cushion length adjustment).

Front Seat

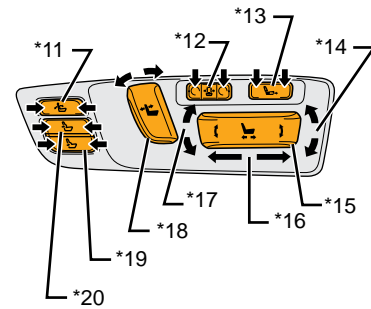
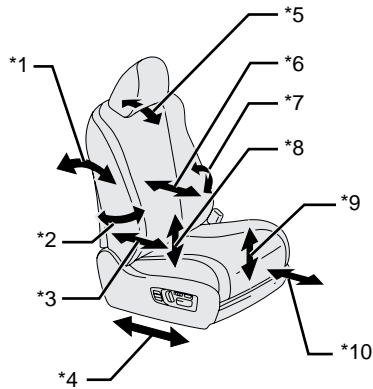

*1	Reclining Adjustment	*2	Side Support Adjustment	*3	Pelvic Support Adjustment
*4	Slide Adjustment	*5	Shoulder Support Adjustment	*6	Lumbar Support Adjustment
*7	Side Support Adjustment	*8	Lifter Adjustment	*9	Front Vertical Adjustment
*10	Cushion Length Adjustment	*11	Shoulder Support Adjustment Switch	*12	Side Support Adjustment Switch
*13	Cushion Length Adjustment Switch	*14	Front Vertical Adjustment	*15	Power Seat Switch
*16	Slide Adjustment	*17	Lifter Adjustment	*18	Reclining Adjustment Switch
*19	Pelvic Support Adjustment Switch	*20	Lumbar Support Adjustment Switch		



NOTICE

- The seat position adjustment functions of a power seat will be disabled when the 12 V battery is disconnected.

- When a vehicle is equipped with the driving position memory function, the driver seat automatically moves backward when the power switch is turned off (auto away function) and moves forward when the power switch is turned on (IG) (auto return function). Whether or not the vehicle is equipped with the driving position memory function can be confirmed by the existence of memory switches in the upper door trim.

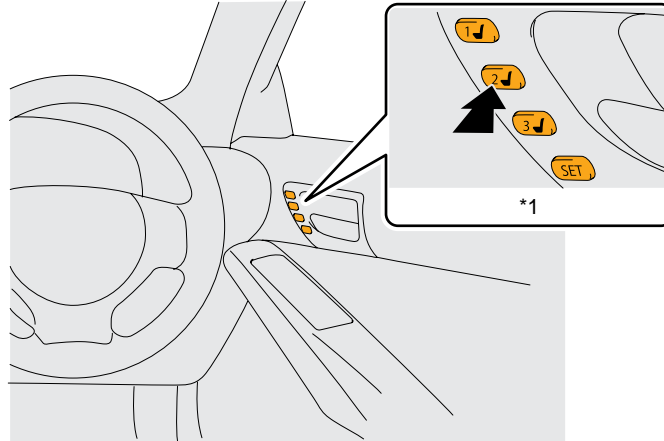

*1	Seat Memory Switch
----	--------------------

Rear Seat

- Two types of rear seats, a manual seat and a power seat, are available. When adjusting the seat position, a lever or a knob is operated for the manual seat and a switch is operated for the power seat.

Manual Seat

- The seat can be moved forward/backward by lifting the slide lever (slide adjustment).
- The seatback can be tilted forward/backward by lifting the reclining lever (reclining adjustment).
- The seat can be tilted forward by pulling the reclining strap.
- The seat can be moved leftward/rightward by lifting the lateral slide handle (lateral slide adjustment).
- The ottoman can be raised/lowered by lifting the ottoman lock handle (ottoman angle adjustment).
- The seat can be turned around by operating the swivel lever.

Rear Seat

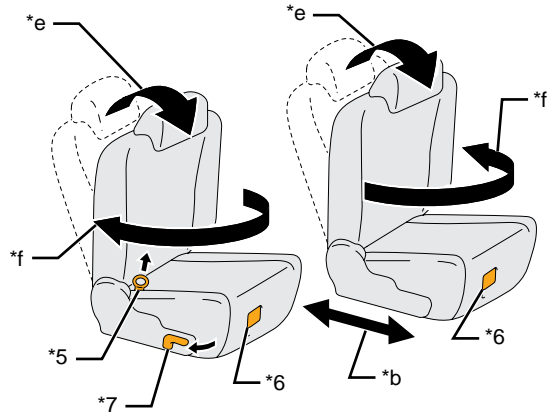
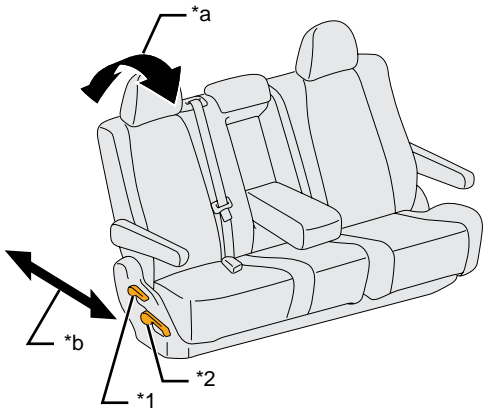
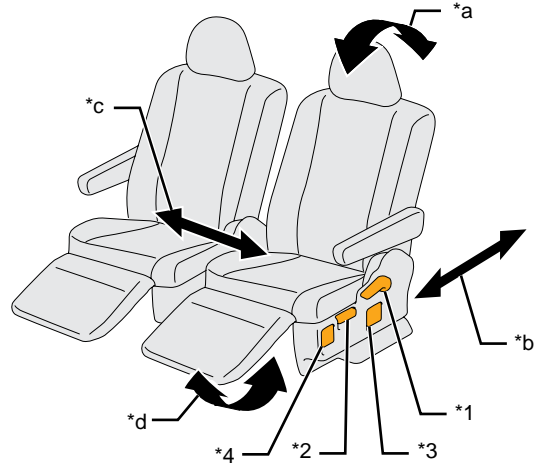
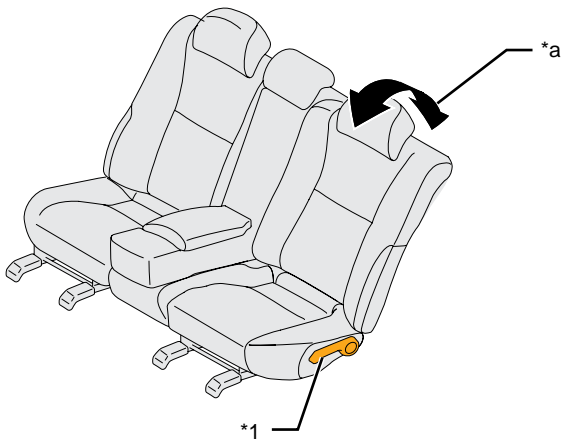

*a	Reclining Adjustment	*b	Slide Adjustment	*c	Lateral Slide Adjustment
*d	Ottoman Angle Adjustment	*e	Forward Tilting	*f	Turning Direction
*1	Reclining Lever	*2	Slide Lever	*3	Lateral Slide Handle
*4	Ottoman Lock Handle	*5	Reclining Strap	*6	Slide Handle
*7	Swivel Lever				

Power Seat

- The seat can be moved forward/backward by operating the slide adjustment switch (slide adjustment).
- The seatback can be tilted forward/backward by operating the reclining adjustment switch (reclining adjustment).
- The ottoman can be raised/lowered by operating the ottoman angle switch (ottoman angle adjustment).
- The angle of the upper seatback can be adjusted vertically by operating the seatback bend angle switch (seatback bend angle adjustment).
- The headrest can be raised/lowered by operating the headrest vertical adjustment switch (headrest vertical adjustment).

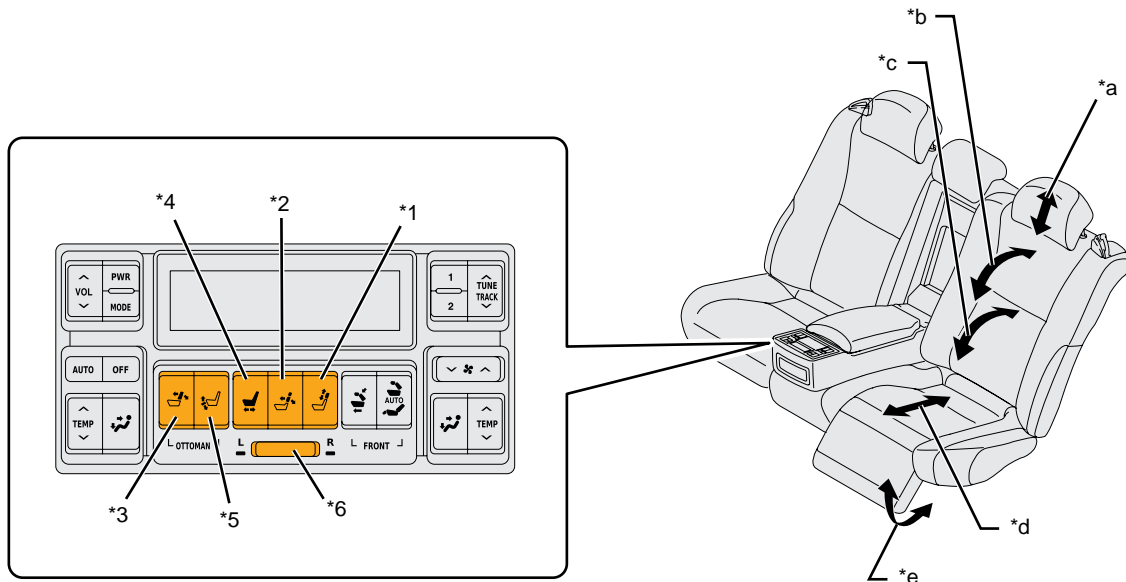

*a	Headrest Vertical Adjustment	*b	Seatback Bend Angle Adjustment	*c	Reclining Adjustment
*d	Slide Adjustment	*e	Ottoman Angle Adjustment		
*1	Headrest Vertical Adjustment Switch	*2	Seatback Bend Angle Adjustment Switch	*3	Reclining Adjustment Switch
*4	Slide Adjustment Switch	*5	Ottoman Angle Adjustment Switch	*6	Seat Select Switch

Headrest

- The position of the headrests can be adjusted vertically and horizontally.
- Two types of headrests, a manual headrest and a power headrest, are available. Vertical adjustment of the headrest is performed by hand on manual headrests or by operating a switch on power headrests. Horizontal adjustment can be performed by hand only.

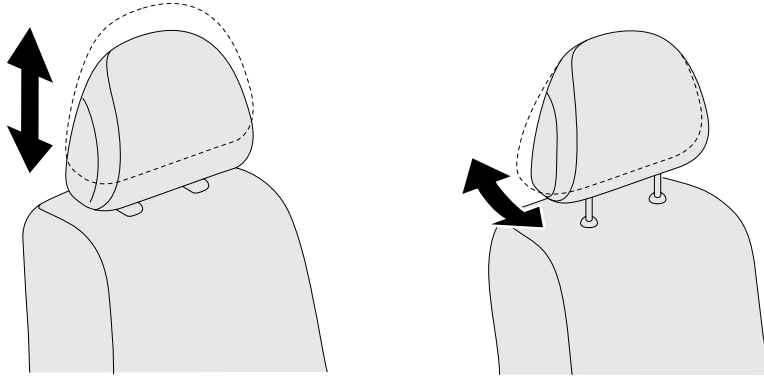

Manual Headrest

- When raising a manual headrest, pull up the headrest by hand. When lowering, push down the headrest while pushing the release button. To remove the headrest, pull out the headrest while pushing the release button.

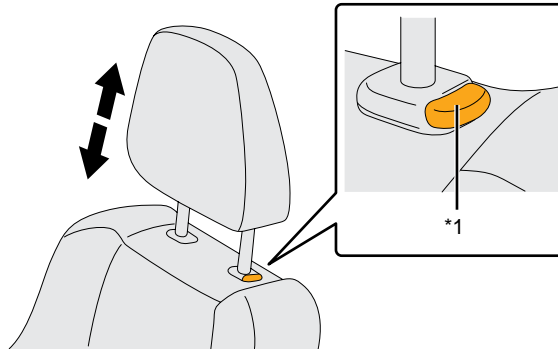

*1	Release Button
----	----------------



NOTICE

- If the headrest cannot be removed by pushing the release button, insert a screwdriver into the release hole provided on the opposite side of the headrest from the release button to release the lock and pull out the headrest.

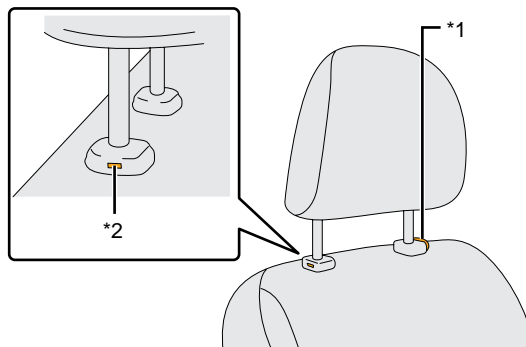

*1	Release Button
----	----------------

*2	Release Hole
----	--------------

Power Headrest

- When raising a power headrest, raise/lower the headrest by operating the power seat switch located on the side of the seat.

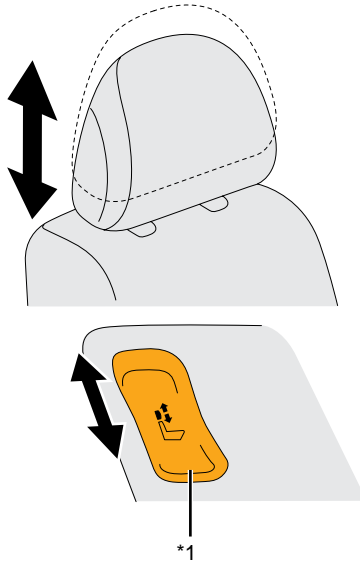

*1 Power Seat Switch



NOTICE

- To remove the headrest, disengage the pins located inside the seatback and pull out the headrest.

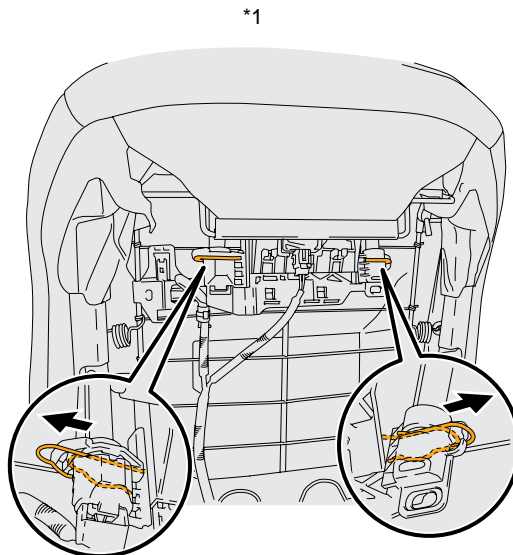

*1 Back of the Seatback



Active Headrest System

- The active headrest system is built into the front headrests.
- The active headrest system consists of an inflator, a rod and a link mechanism.
- When the airbag sensor detects a rear impact, an ignition signal is sent to the inflators to activate the active headrest system. When an inflator is ignited, pressure inside the inflator rises, pushing up a piston. As the piston rises, the rod in the headrest stay is pushed up, a lock is released via the link mechanism and the headrest is pushed forward by a spring, helping reduce the possibility of whiplash injuries.

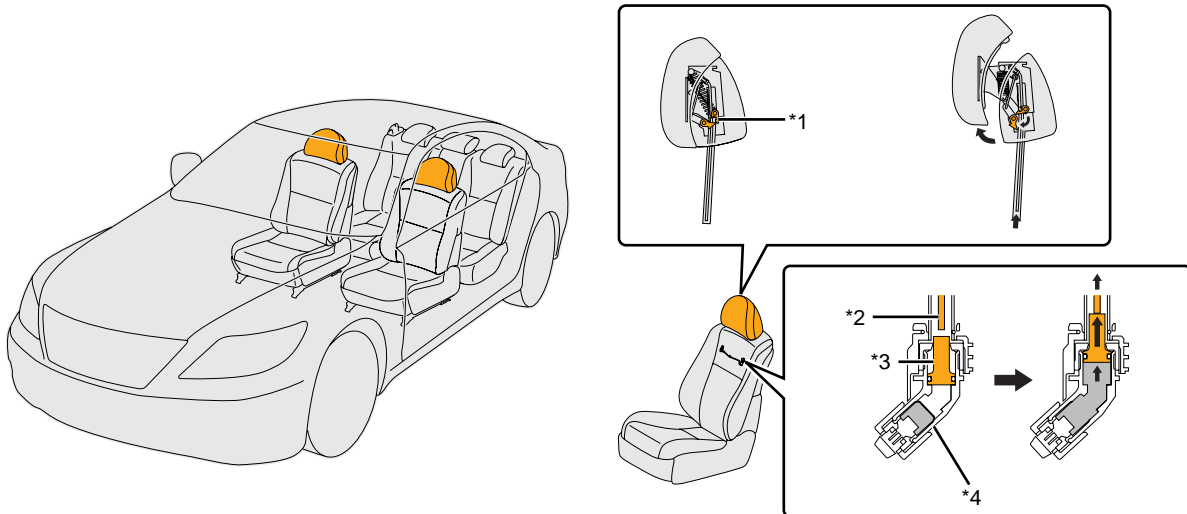

*1	Link Mechanism	*2	Rod
*3	Piston	*4	Inflator



- The active headrest system may remain powered for up to 90 seconds after the vehicle is shut off and disabled (see page 57). Wait at least 90 seconds before starting any operation. Failure to shut off and disable the vehicle before emergency response procedures are performed may result in serious injury or death from unintentional actuation of the active headrest.
- If an inflator is cut, the active headrest inflator may unintentionally deploy. To prevent serious injury or death from unintentional active headrest actuation, avoid breaching the inflators.

Tilt & Telescopic Steering

- The steering column has a tilt mechanism, which enables vertical adjustment of the steering wheel position, and a telescopic mechanism, which enables horizontal adjustment of the steering wheel position.
- Two types of tilt & telescopic steering, manual tilt & telescopic steering and power tilt & telescopic steering, are available. When adjusting the position of the steering wheel, a lever is operated for the manual tilt and telescopic mechanisms and a switch is operated for the power tilt and telescopic mechanisms.
- Some vehicles have only tilt or telescopic mechanism, not both. Also, some vehicles have a fixed type steering column (not equipped with tilt & telescopic mechanism), and some vehicles power mechanism is only for tilt or telescopic function.

Manual Tilt & Telescopic

- The manual tilt & telescopic steering is provided with a lock lever under or side of steering column for releasing the lock when adjusting the steering wheel position.
- When the lock lever is operated, the lock is released, allowing adjustment of the steering wheel position. After adjustment, the steering wheel can be locked in the desired position by returning the lock lever.

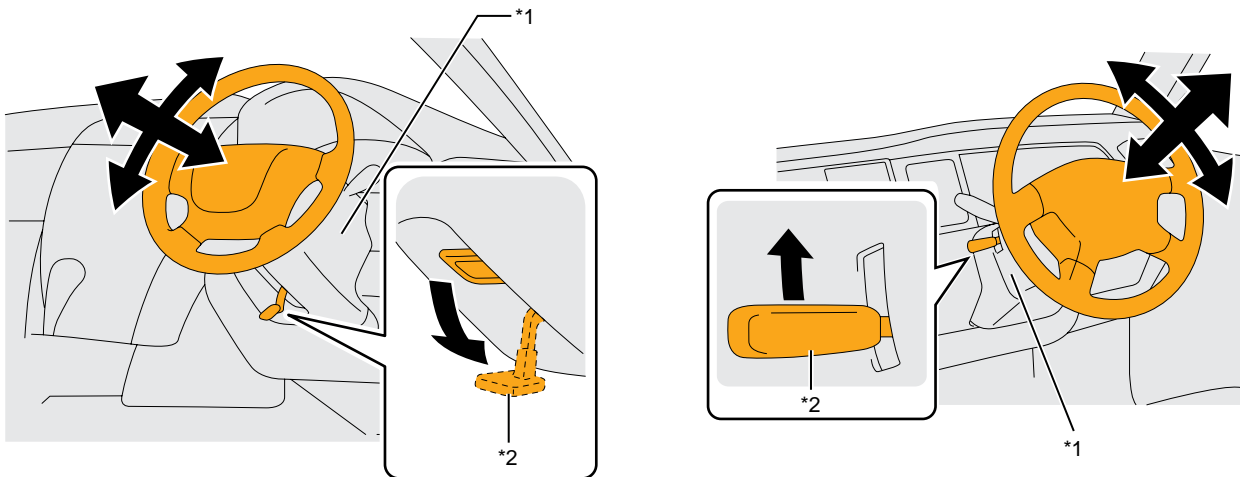

*1	Steering Column	*2	Lock Lever
----	-----------------	----	------------

Power Tilt & Telescopic

- The power tilt & telescopic steering is provided with a switch on the steering column for adjusting the steering wheel position.
- The steering wheel can be moved to a desired position by operating the switch.

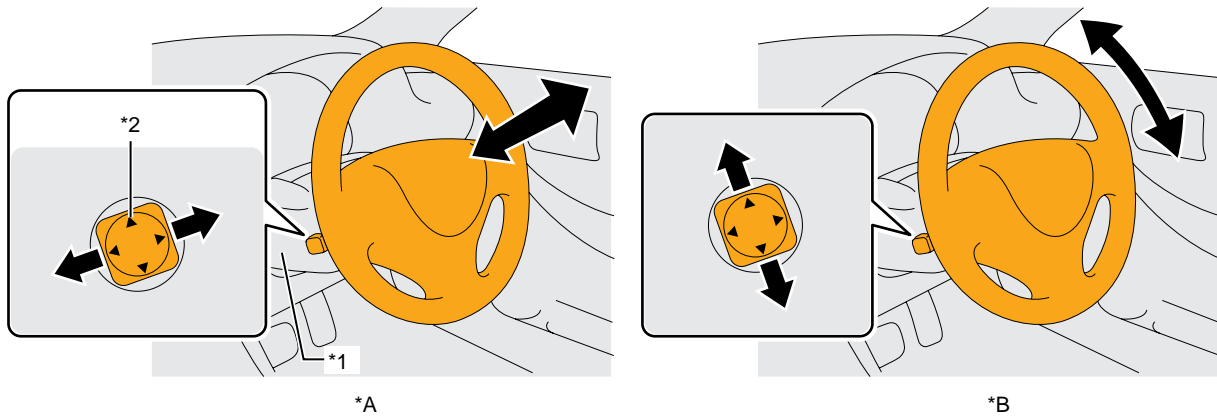

*A	Telescopic Mechanism	*B	Tilt Mechanism
*1	Steering Column	*2	Steering Wheel Adjustment Switch

Emergency Response Key Points

- Procedures and points to be noted when handling TOYOTA vehicles during emergency response are provided in this section.
- Refer to the Rescue Sheet for each model for model specific information such as vehicle identification points, component locations, etc.

Access Occupants

- Make sure that the vehicle is immobilised and disabled (see page 57), then open or remove windows and doors to access patients.
- Secure the necessary space for performing operations by adjusting the position of the steering wheel and seats and removing the head rests.



WARNING

- The SRS airbags, seat belt pretensioners, pedestrian protection active system and active headrests may remain powered for up to 90 seconds after the vehicle is shut off and disabled (see page 57). Wait at least 90 seconds before starting any operation. Failure to shut off and disable the vehicle before emergency response procedures are performed may result in serious injury or death from unintentional deployment of the SRS airbags or unintentional actuation of the seat belt pretensioners, pedestrian protection active system or active headrests.
- Depending on the circumstances surrounding a collision, such as vehicle speed, point of impact, occupant detection etc., the SRS airbags, seat belt pretensioners, pedestrian protection active system or active headrests will not always be activated and may remain active. If an unactivated inflator of these systems is cut, the powder inside the inflator may ignite resulting in airbag deployment. To prevent serious injury or death from unintentional SRS airbag deployment or unintentional actuation of the seat belt pretensioners, pedestrian protection active system or active headrests, avoid breaching the inflators.
- Immediately after an SRS airbag is deployed or a seat belt pretensioners, the pedestrian protection active system or an active headrest is actuated, the components are extremely hot and may cause burns if touched.
- If an SRS airbag deploys with all doors and windows closed, inflation gas may cause breathing difficulty.
- If residue that is produced during the operation of SRS airbags, seat belt pretensioners, pedestrian protection active system or active headrests comes in contact with skin, rinse it off immediately to prevent skin irritation.

Vehicle with High Voltage Battery

- Hybrid vehicles (HEV), plug-in hybrid vehicles (PHEV), electric vehicles (BEV) and fuel cell vehicles (FCEV) are equipped with a high voltage electrical system (120 to 800 V).



WARNING

- The high voltage system may remain charged for up to 10 minutes after the vehicle is shut off and disabled (see page 57). Failure to shut off and disable the vehicle before emergency response procedures are performed may result in serious injury or death from severe burns and electric shock from the high voltage electrical system.
- To prevent serious injury or death from severe burns or electric shock, avoid touching, cutting, or breaching any orange high voltage power cable or high voltage component. Wear appropriate protective equipment such as insulated gloves when there is a risk of touching high voltage power cables or high voltage components.

Vehicle with Hydrogen Gas

- Fuel cell vehicles (FCEV) carry compressed hydrogen gas.



WARNING

- Hydrogen gas is colourless, odorless and flammable.
- Compared to petrol or natural gas, hydrogen gas can ignite in a wide range of concentrations (4 to 74.5%). If the sound of hydrogen leaking (a loud hissing sound) can be heard when working on the vehicle, or if the hydrogen concentration around the vehicle exceeds 1% when measured with a hydrogen concentration detector, immediately step away from the vehicle as there is a chance that the hydrogen gas may ignite.
- Even after the vehicle is stopped (see page 57), hydrogen remains inside the FC stack, hydrogen tanks and other hydrogen-related parts, as well as inside the hydrogen pipe. In order to avoid fires and explosions, never cut or damage these hydrogen-related parts or the hydrogen pipe.
- If there is any hydrogen leakage, do not use any electrical or rescue equipment that may produce static electricity, as this may ignite the hydrogen.

Cut Vehicle

- Pay special attention to the location of structural reinforcements, fuel system, SRS and high voltage electrical system components when cutting a vehicle.
- Refer to the Rescue Sheet for each model for model specific information such as component locations, etc.

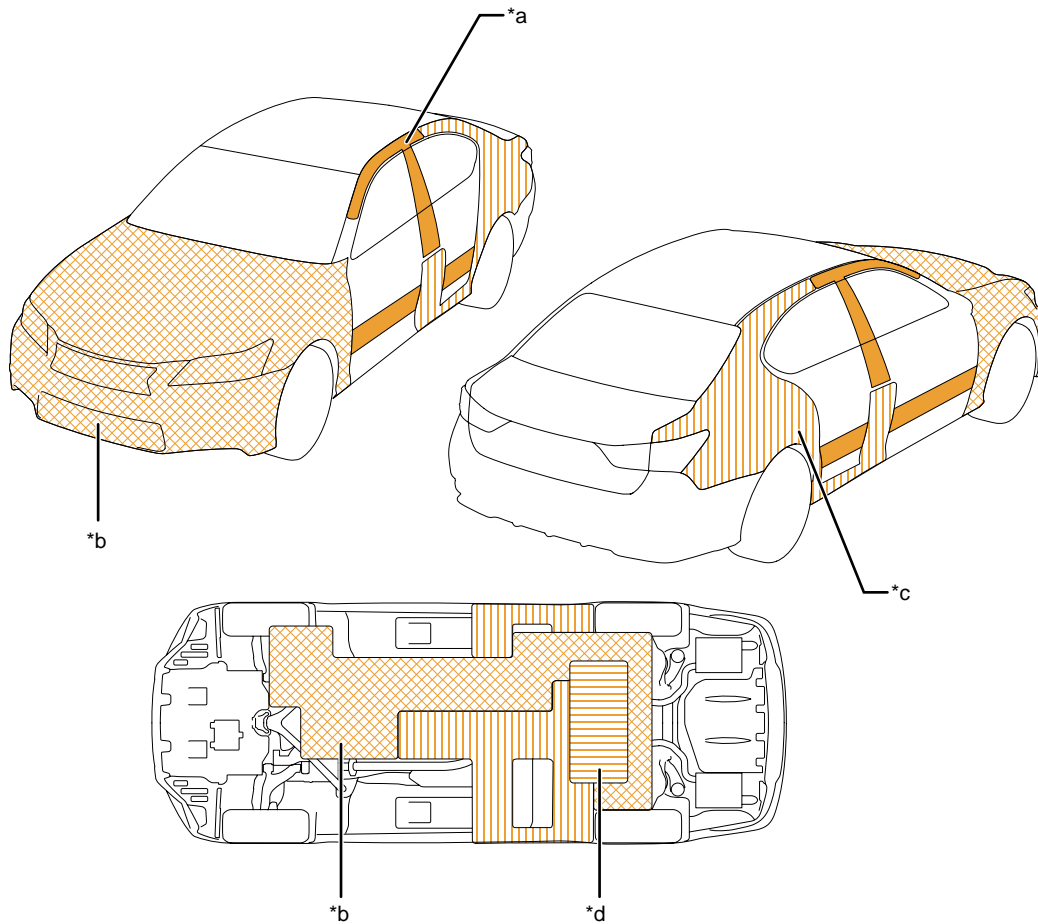

*a	Structural Reinforcements	*b	High Voltage Electrical System Components
*c	SRS Components	*d	Fuel System Components



WARNING

- To prevent serious injury from a fire caused by sparks, use a hydraulic cutter or other tools that do not generate sparks when cutting the vehicle.

- If the SRS airbag, seat belt pretensioner, pedestrian protection active system or active headrest has already been activated, the inflator can be cut.

Components Requiring Special Attention

- The construction and functions of components requiring special attention during emergency response are described in this section.

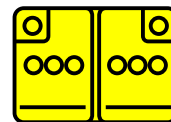

Battery low voltage

12 V Battery

- The 12 V battery supplies power to the ECUs that control various systems and auxiliary components such as the power door lock, power window, power tilt and telescopic steering, power seat, etc.
- To ensure safe emergency response operations, it is necessary to completely shut off the vehicle (see page 57). Disconnect the negative battery terminal from the 12 V battery before performing work and shut off the power to the electrical system to prevent electrical fires and to keep the vehicle from starting.
- 12 V battery electrolyte contains dilute sulfuric acid.
- Depending on the model the 12 V battery is installed in the engine compartment, luggage compartment, under the rear seats, etc.
- Refer to the Rescue Sheet for each model for locations of the 12 V battery.

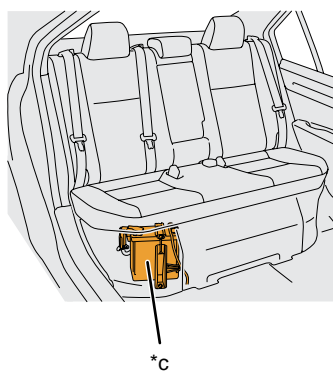
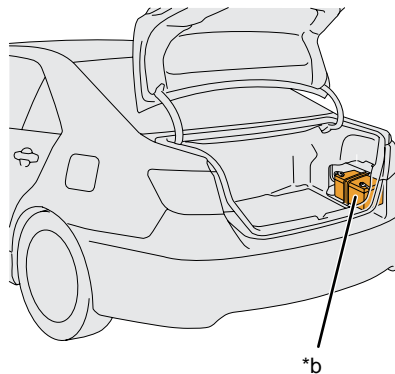
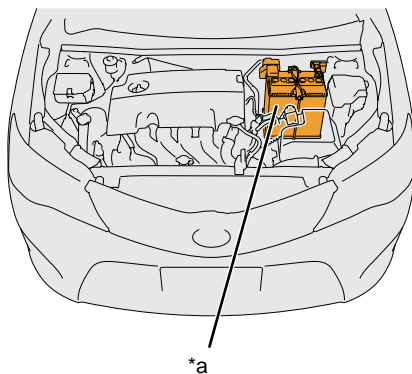

*a	Engine Compartment	*b	Luggage Compartment
*c	Under Rear Seat		

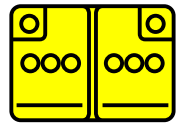

WARNING

- There is a possibility of explosion due to ignition of the hydrogen gas generated from the 12 V battery. Therefore, do not allow any open sparks or open flames nearby the 12 V battery.
- Dilute sulfuric acid may cause irritation of the skin if contacted. Wear appropriate protective equipment such as rubber gloves and safety goggles when there is a risk of touching electrolyte.



NOTICE

- Once the 12 V battery is disconnected (see page 57), power controls will not operate. To facilitate emergency response operations, lower the windows, open the back door, unlock the doors and take other necessary actions before shutting off the vehicle.
- 12 V battery electrolyte contains ingredients that damage painted surfaces. If any comes in contact with the vehicle body, discolouration or other damage may occur.

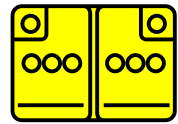

Sub-battery

- A sub-battery is installed in vehicles equipped with an electro shiftmatic system and advanced drive system.
- Dual systemization of the 12 V battery power supply enables the parking brake lock operation and advanced drive control when the 12 V battery malfunctions.
- By disconnecting the negative (-) terminal of the 12 V battery and shutting of the electricity for 10 minutes or more, the protection relay inside the sub-battery is released and the voltage drops to 0 V.
- One sub-battery is a nickel-metal hydride (Ni-MH) battery, and the other is a lithium ion (Li-ion) battery.
- The nickel-metal hydride (Ni-MH) sub-battery consists of 10 1.2 V nickel-metal hydride automotive batteries connected in series, ensuring a 12 V power source.
- The lithium ion (Li-ion) sub-battery consists of four 3.7 V lithium ion automotive batteries connected in series, ensuring a 12 V power source.
- The Ni-MH battery contains a strong alkaline electrolyte (pH 13.5). The electrolyte is absorbed in the cell plates, but it may leak in cases of damage to the high voltage battery. However, it would not be a large amount.
- The Li-ion battery electrolyte, mainly consists of carbonate ester, is a flammable organic electrolyte. The electrolyte is absorbed into the electrodes and the separators. It may leak in cases of damage to the high voltage battery, but it would not be a large amount.

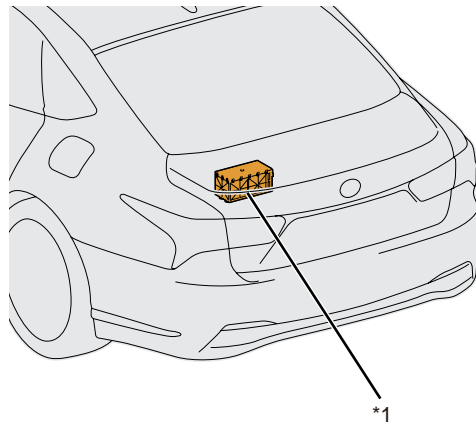
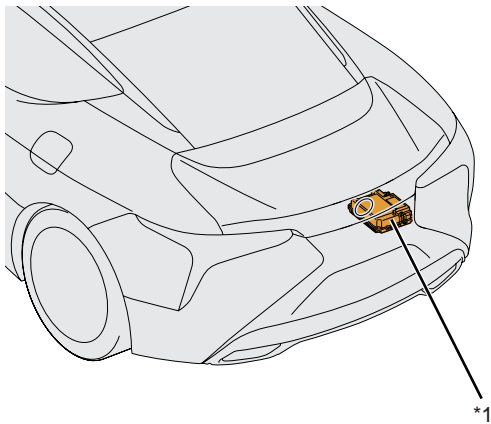

*1	Sub-battery
----	-------------

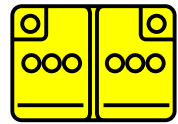

WARNING

- There is a possibility of explosion due to ignition of the hydrogen gas generated from the sub-battery. Therefore, do not allow any open sparks or open flames nearby the sub-battery.
- The strong alkaline (pH 13.5) potassium hydroxide water solution contained in the nickel-metal hydride (Ni-MH) battery is harmful to the human body. In cases where touching the electrolyte is unavoidable or there is a danger of it being touched, perform work wearing appropriate protective equipment such as rubber gloves and safety goggles.
- The flammable organic electrolyte in the lithium ion (Li-on) battery primarily contains carbonate ester and is harmful to the human body. In case of contact with the electrolyte, it may irritate the eyes, nose, throat, and skin. In case of contact with the smoke or vapor from leaked electrolyte or a burning battery, it may irritate the eyes, nose, or throat. In cases where touching the electrolyte is unavoidable or there is a danger of it being touched, perform work wearing appropriate protective equipment such as rubber gloves, safety goggles, a protective mask, or a self-contained breathing apparatus (SCBA).
- If electrolyte leaks from the lithium ion (Li-on) battery, keep it away from fire and ensure the area is well ventilated. Absorb the electrolyte with a cloth or equivalent absorbing material and keep it in an airtight container.



NOTICE

- After the negative (-) terminal of the 12 V battery has been disconnected and the power has been shut off, approximately 12 V is maintained between the positive (+) terminal and negative (-) terminal of the sub-battery for up to approximately 10 minutes.

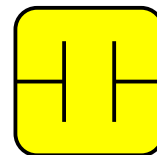

Ultra-capacitor, low-voltage

- The ultra-capacitor, low-voltage is installed inside the centre console.
- By using an internal condenser, the supply of power is ensured.
- For the detailed installation locations of ultra-capacitor, low-voltage for each model, refer to the Rescue Sheet for each model.

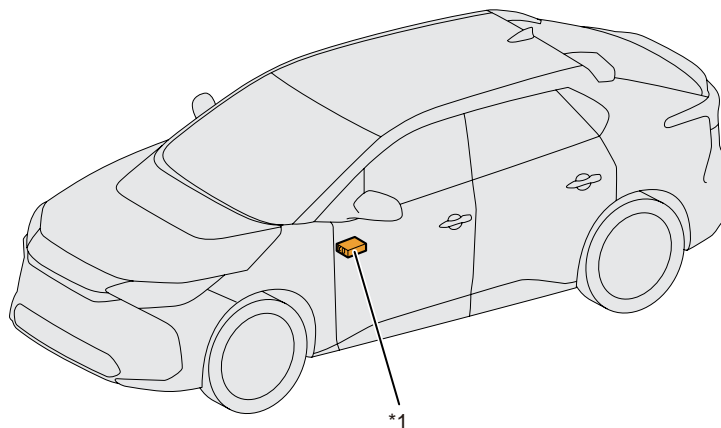

*1 Ultra-capacitor, low-voltage



NOTICE

- After the negative (-) terminal of the 12 V battery has been disconnected and the power has been shut off, approximately 12 V is maintained between the positive (+) terminal and negative (-) terminal of the ultra-capacitor, low-voltage for up to approximately 10 minutes.



High Voltage System

High Voltage Battery

- The high voltage battery for the motor stores high voltage electricity (120 to 800 V). Depending on the model the battery is installed in the luggage compartment, under the rear seats, under the centre console or under the floor.

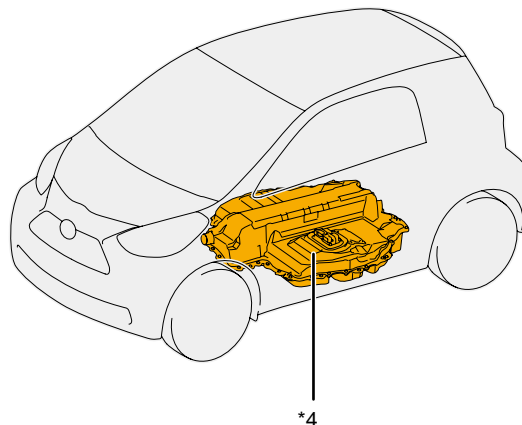
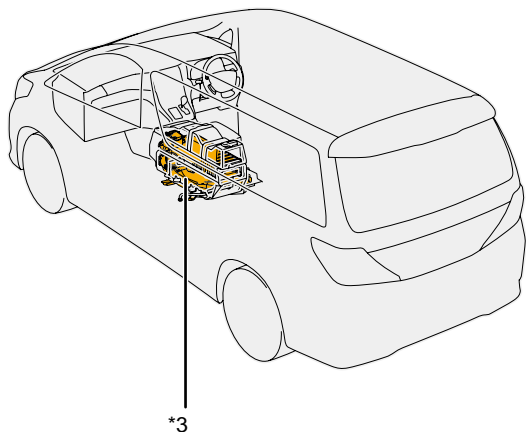
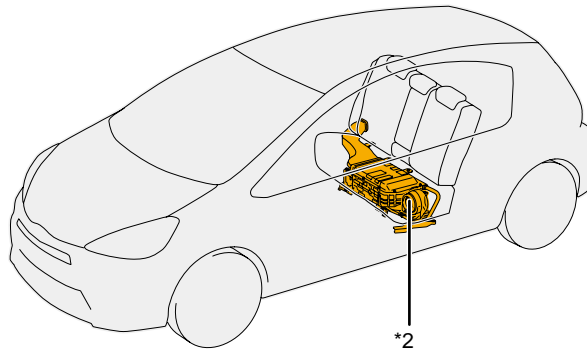
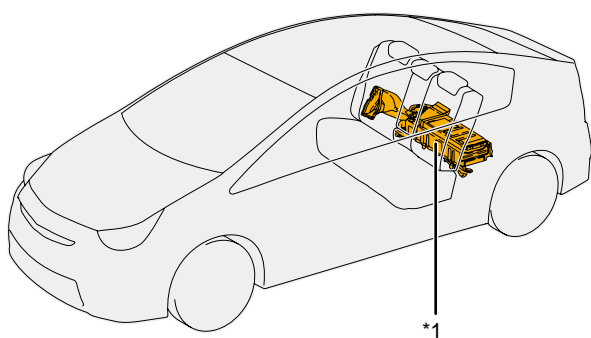

*1	Luggage Compartment	*2	Under Rear Seat
*3	Under Centre Console	*4	Undercarriage

- An under-bonnet label shows the location of the high voltage battery.

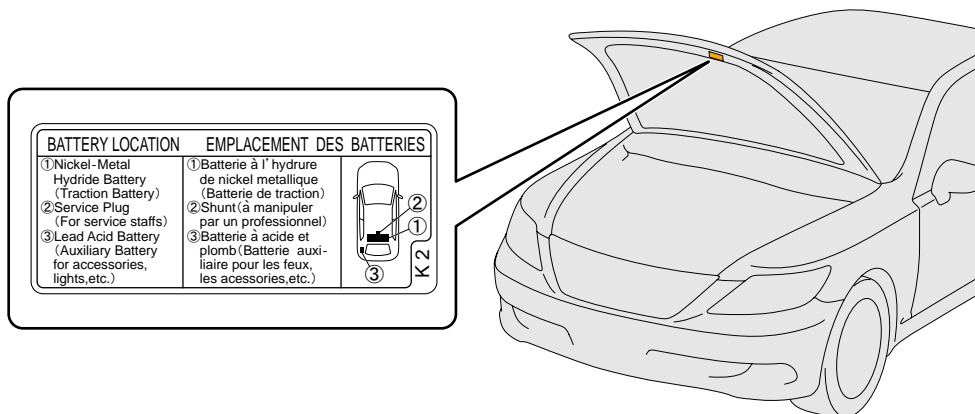



- A Nickel-metal hydride (Ni-MH) battery or lithium ion (Li-ion) battery is used as the high voltage battery.

1. Nickel-metal hydride (Ni-MH) battery

- These batteries consist of multiple modules, each module consisting of six 1.2 V cells, connected in series to obtain a high voltage (120 to 400 V).
- The battery modules are sealed in a case and cannot easily be touched.
- The Ni-MH battery contains a strong alkaline electrolyte (pH 13.5). The electrolyte, however, is absorbed in the cell plates and will not normally spill or leak out even if a battery module is cracked.
- Electrolyte leakage from the HV battery pack is unlikely due to its construction and the amount of available electrolyte contained within the Ni-MH modules. Any spillage would not warrant a declaration as a hazardous material incident.

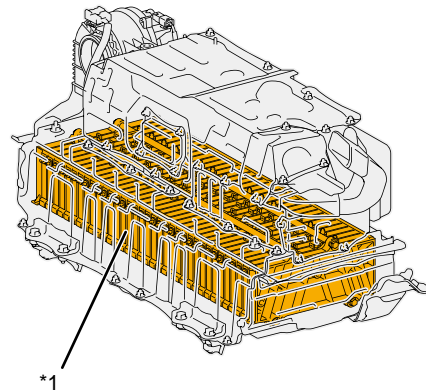
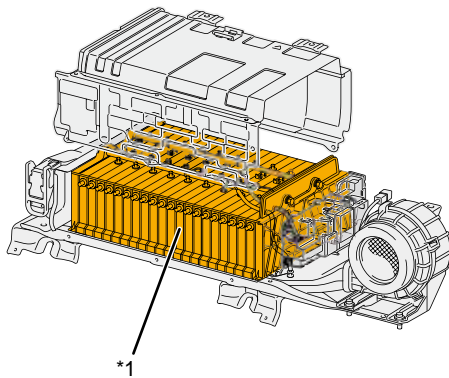

*1	Battery Module
----	----------------



WARNING

- Strong alkaline electrolyte (pH 13.5) is harmful to the human body. To avoid injury by coming in contact with the electrolyte, wear appropriate protective equipment such as rubber gloves and safety goggles when there is a risk of touching electrolyte.



2. Lithium ion (Li-ion) battery

- Li-ion batteries consist of multiple stacks. Each stack consists of multiple cells, and the stacks are connected in series to obtain high voltage (120 to 800 V).
- The battery cells are sealed in a case and cannot easily be touched.
- The Li-ion battery electrolyte, mainly consists of carbonate ester, is a flammable organic electrolyte. The electrolyte is absorbed into the battery cell separators, even if the battery cells are crushed or cracked, it is unlikely that liquid electrolyte will leak.
- Any liquid electrolyte that leaks from a Li-ion battery cell quickly evaporates.

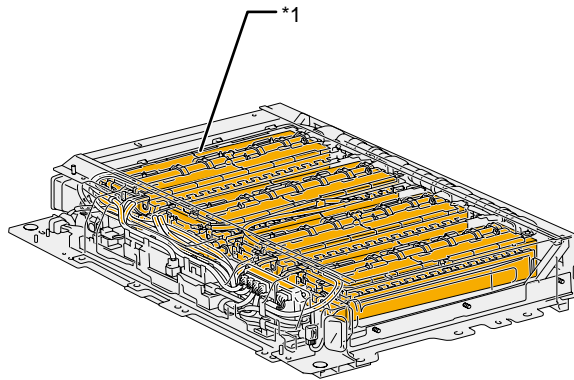
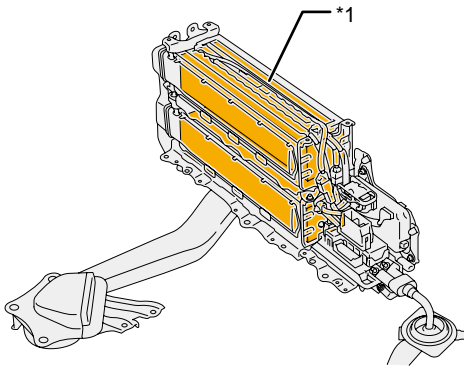

*1 Battery Stack



WARNING

- The flammable organic electrolyte which primarily contains carbonate ester is harmful to the human body. In case of contact with the electrolyte, it may irritate the eyes, nose, throat and skin. In case of contact with the smoke or vapor from leaked electrolyte or a burning battery, it may irritate the eyes, nose or throat. To avoid injury by coming in contact with the electrolyte or vapor, wear appropriate protective equipment such as rubber gloves, safety goggles, protective mask or SCBA when there is a risk of touching electrolyte.
- If the electrolyte spills, keep it away from fire and ensure the area is well ventilated. Absorb the electrolyte with a waste cloth or equivalent absorbing material and keep it in an airtight container until disposed of.



Fuel Cell (FC) System

FC Stack

- The FC stack is a device to generate electricity through the chemical reaction between hydrogen and oxygen. Using the hydrogen supplied by the hydrogen tank and oxygen in the air drawn in from outside the vehicle, a high voltage of 200 V or higher is generated.
- The FC stack generates power using so called “cells”, which are comprised of an electrolyte membrane sandwiched by separators. A few hundred cells are connected in a row to generate a high voltage.
- The cells are sealed in a case and cannot easily be touched.
- Water is generated through the chemical reaction between hydrogen and oxygen during power generation, and discharged via the discharge outlet.

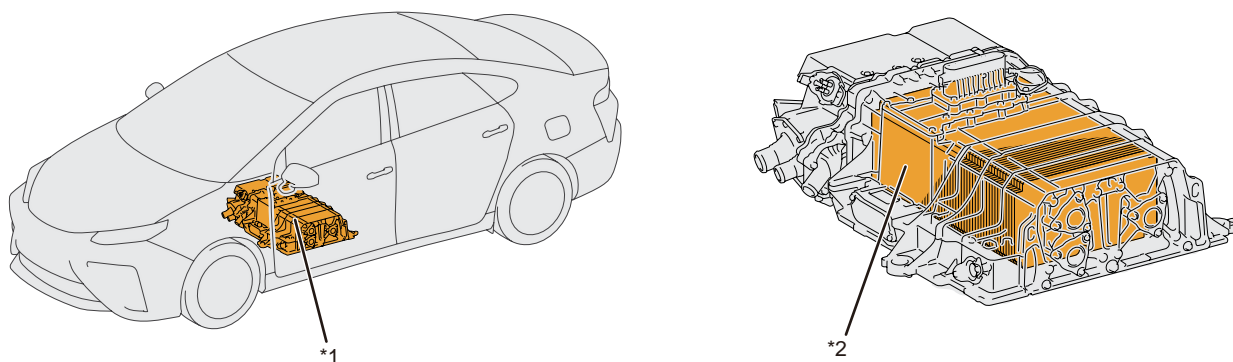

*1	FC Stack	*2	Cell
----	----------	----	------

- An under-bonnet label shows the location of the FC stack.

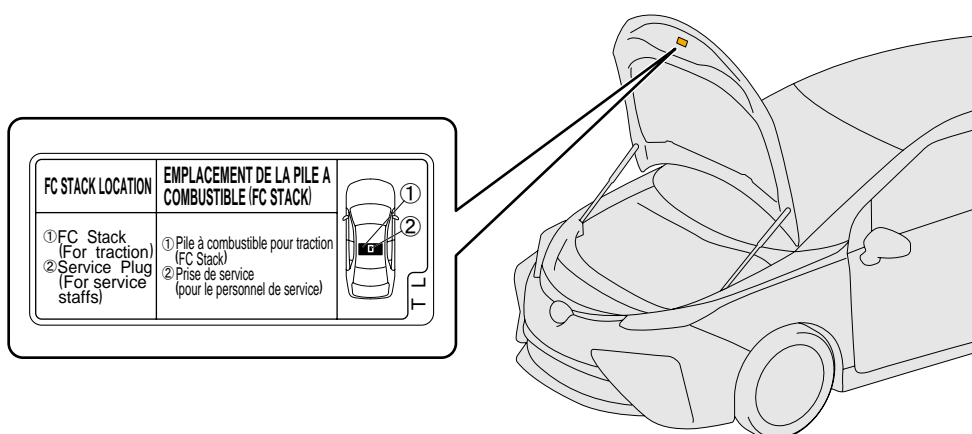



Hydrogen Tank

- The hydrogen tanks are filled with high pressure hydrogen gas (a maximum of 70 MPa (714 kgf/cm², 10,153 psi) at 15°C (59°F)) that is supplied to the FC stack.
- The hydrogen tanks are made of carbon fibre-reinforced plastic and located underneath the floor.
- The hydrogen detector used to detect hydrogen leaks is located near the tanks. If a specified concentration of hydrogen leakage is detected, the FC system cuts off the supply of hydrogen.
- Each tank is equipped with a thermal pressure relief device (TPRD) in order to prevent an explosion when the temperature of the hydrogen reaches abnormal levels due to a vehicle fire. The pressure relief device will open at approximately 110°C (230°F) to release the hydrogen gas in the tank outside of the vehicle.

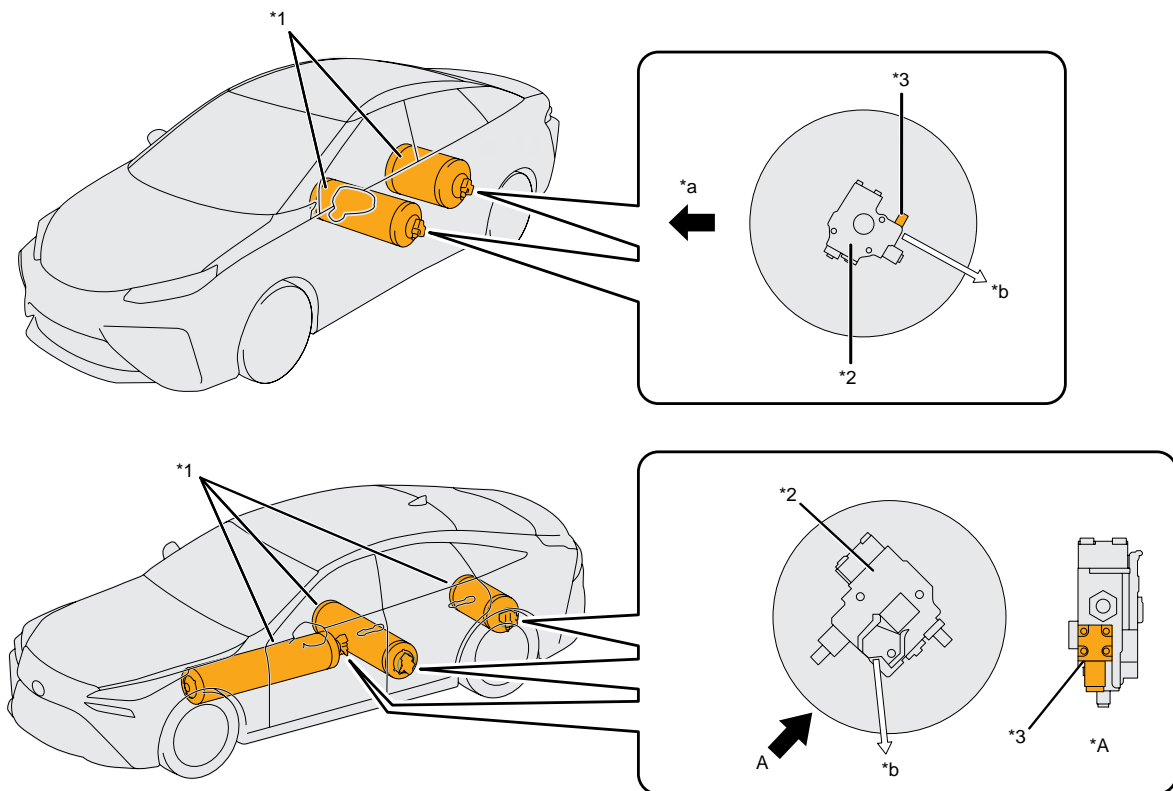

*A	View A		
*1	Hydrogen Tanks	*2	Tank Valve
*3	Thermal Pressure Relief Device (TPRD)		
*a	Front of Vehicle	*b	Jet Angle



NOTICE

- Depending on the model, multiple hydrogen tanks may be installed. For the detailed installation locations of hydrogen tanks for each model, refer to the Rescue Sheet for each model.

Hydrogen Pipes

- The hydrogen pipes connect the hydrogen-related parts such as the FC stack and hydrogen tanks.
- The hydrogen pipes are located underneath the floor.
- Some of the high-pressure hydrogen pipes are identified in red.

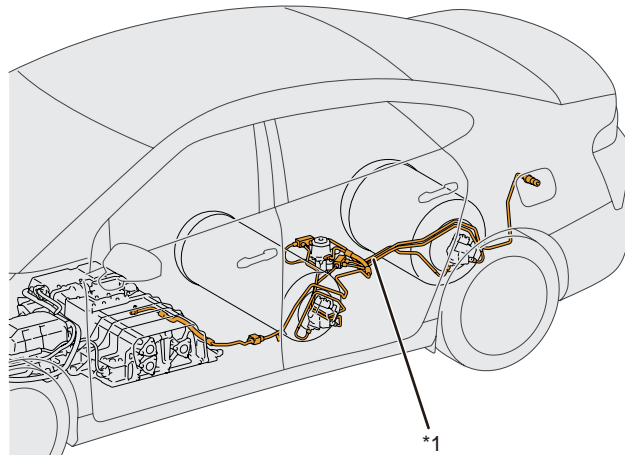

*1	Hydrogen Pipes
----	----------------



Hydrogen Pump

- The hydrogen pump circulates the hydrogen supplied from the hydrogen tanks into the FC stack.
- The hydrogen pump has a built-in motor that is operated using the high voltage from the FC water pump and hydrogen pump inverter. The hydrogen pump is installed underneath a cover at the side of the FC stack.

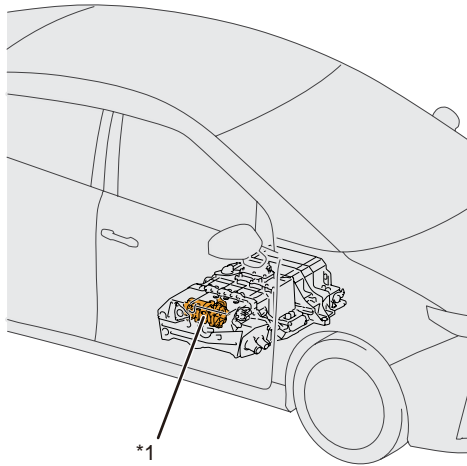

*1	Hydrogen Pump
----	---------------



CNG Tank

- The Compressed Natural Gas (CNG) tank is filled with compressed natural gas that is used as fuel for the engine at a maximum pressure of 20 MPa (204 kgf/cm², 2,900 psi).
- The CNG tank is made of metal and located in the luggage compartment, etc.
- The CNG tank is equipped with a pressure relief device (PRD) in order to prevent an explosion when the temperature of the natural gas reaches abnormal levels due to a vehicle fire. The pressure relief device will open at approximately 110°C (230°F) to release the natural gas in the tank outside of the vehicle.
- Natural gas is flammable and can ignite within a concentration of 5.3 to 15.0%.
- Natural gas mainly consists of methane, is harmless and diffuses upwards as it is lighter than air. Also, the gas is infused with a smell so that a leak can be quickly detected.

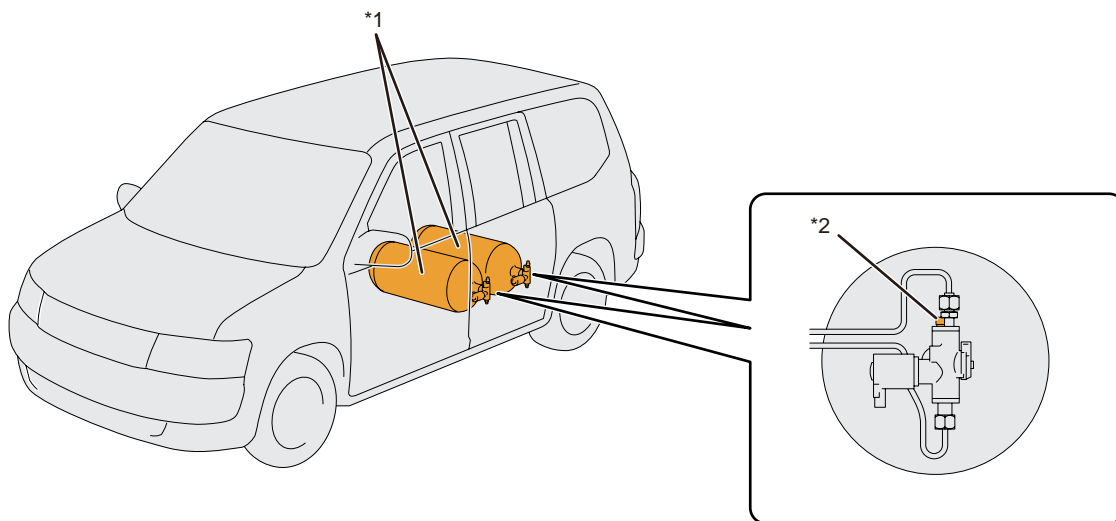

*1	CNG Tank	*2	Pressure Relief Device (PRD)
----	----------	----	------------------------------



WARNING

- If the sound of natural gas leaking (a loud hissing sound) can be heard when working on the vehicle, or if the smell of natural gas is present, immediately step away from the vehicle as there is a chance that the natural gas may ignite.



LPG Tank

- The Liquefied Petroleum Gas (LPG) tank is filled with compressed liquefied propane, butane, etc. that is used as fuel for the engine at a pressure of 1 MPa (10.2 kgf/cm², 145 psi) or less.
- The LPG tank is made of metal and located in the luggage compartment, etc.
- The LPG tank is equipped with a pressure relief device (PRD) in order to prevent an explosion when the pressure of the LPG reaches abnormal levels due to a vehicle fire. The pressure relief device will open when the pressure in the tank reaches a certain pressure to release the gas in the tank outside the vehicle.
- LPG is flammable and can ignite within a concentration of 2.4 to 9.5%.
- The main components of LPG, propane and butane are harmless and remain close to the ground as they are heavier than air. Also, the gas is infused with a smell so that a leak can be quickly detected.

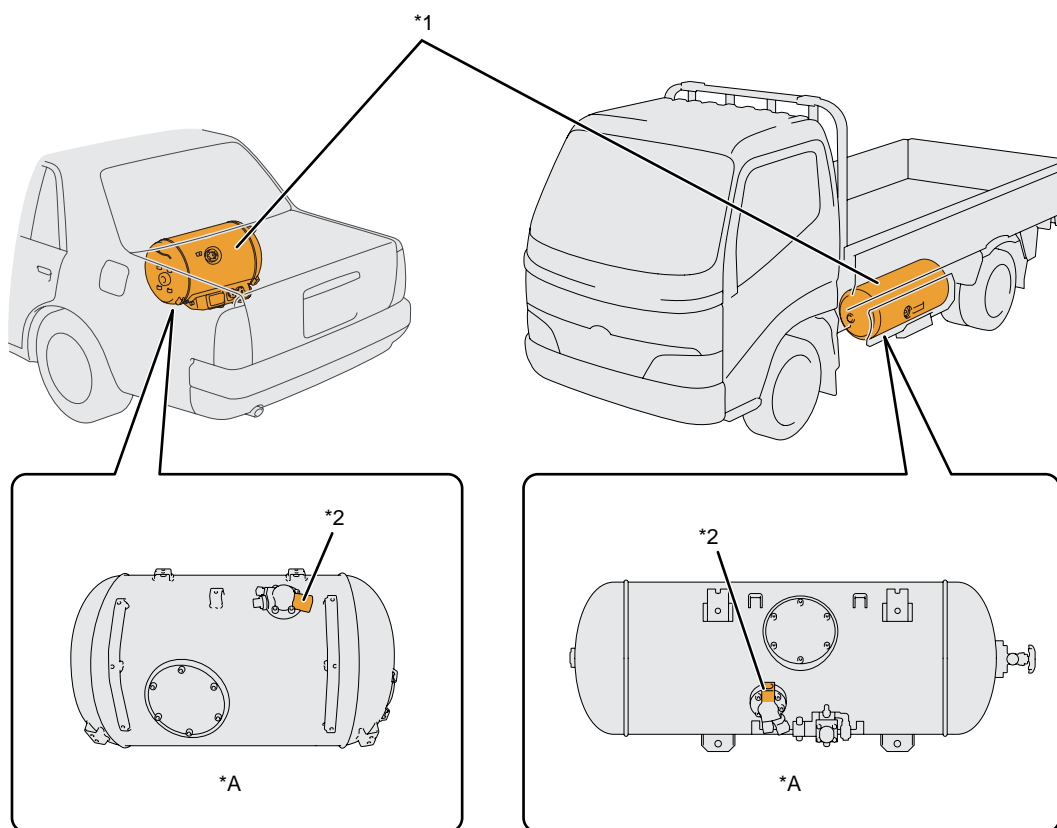

*A	Bottom view of tank		
*1	LPG Tank	*2	Pressure Relief Device (PRD)



- If the sound of LPG leaking (a loud hissing sound) can be heard when working on the vehicle, or if the smell of LPG is present, immediately step away from the vehicle as there is a chance that the LPG may ignite.

Air Tank

- The air tank stores compressed air required for vehicle height adjustment.
- The air tank is made of metal and installed in spaces such as under the luggage room.

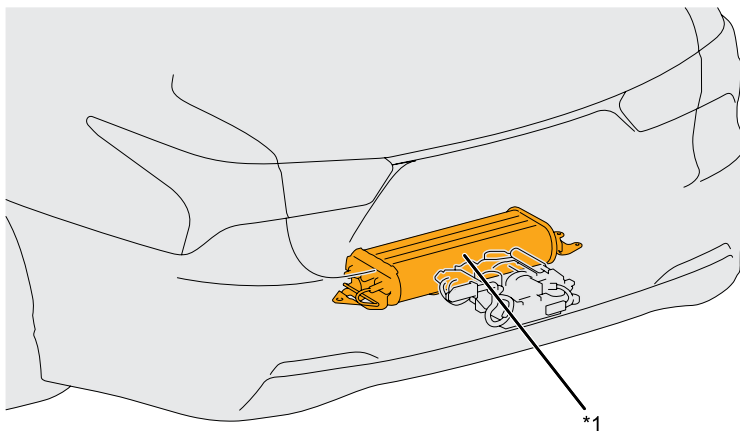

*1 Air Tank

Urea Selective Catalytic Reduction (SCR) System

- The urea Selective Catalytic Reduction (SCR) system reduces harmful nitrogen oxides (NOx) in the exhaust gas using a urea solution (AdBlue).
- The urea solution (AdBlue) is stored in the urea tank installed below the floor, etc.
- The urea solution (AdBlue) is a colourless, odorless and harmless liquid. However, when the temperature is high, such as in the summer, there is a possibility that an irritating odor is produced by the thermolysis of urea solution (AdBlue).
- The urea solution (AdBlue) is noncombustible. However, if the urea solution (AdBlue) is heated due to a fire, etc., it breaks down and may emit a harmful gas.

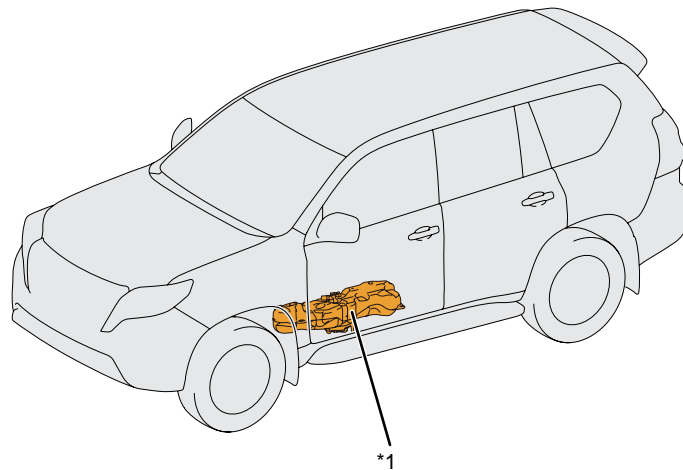

*1	Urea Tank
----	-----------



WARNING

- If you come in contact with smoke or vapor from a burning urea tank, it may irritate the eyes, nose or throat. To avoid injury by coming in contact with the smoke or vapor from a burning urea tank, wear appropriate protective equipment such as rubber gloves, safety goggles, a protective mask or SCBA when there is a risk of contacting the smoke or vapor.

Emergency Response Key Points

- Procedures and points to be noted when handling TOYOTA vehicles during emergency response are provided in this section.
- Refer to the Rescue Sheet for each model for model specific information such as vehicle identification points, component locations, etc.

Spills

- Vehicles contain various fluids such as petrol, coolant, engine oil, transmission oil, brake fluid, power steering fluid, window washer fluid and 12 V battery electrolyte.

Coolant

- Long Life Coolant (LLC) that is used to cool the engine and inverter contains ethylene glycol for freezing temperature control and anticorrosion additives for preventing metal components from corroding.

Lubrication Oil

- Engine oil, transmission oil and gear oil are used for lubrication and contain mineral oils and synthetic oils.

Brake Fluid

- Brake fluid contains several types of glycol-ether and anticorrosion additives for preventing metal components from corroding.



NOTICE

- Brake fluid contains ingredients that damage painted surfaces. If any comes in contact with the vehicle body, the paint may come off.

Power Steering Fluid

- Power steering fluid contain mineral oils and synthetic oils.

Window Washer Fluid

- Window washer fluid contains alcohol for freezing temperature control.

12 V Battery Electrolyte

- 12 V battery electrolyte contains dilute sulfuric acid.



- Dilute sulfuric acid may cause irritation of the skin if contacted. Wear appropriate protective equipment such as rubber gloves and safety goggles when there is a risk of touching electrolyte.



- 12 V battery electrolyte contains ingredients that damage painted surfaces. If any comes in contact with the vehicle body, discolouration or other damage may occur.

Sub-battery Electrolyte

- There are 2 types of high voltage battery; the nickel-metal hydride type and the lithium ion type.

1. Nickel-metal hydride (Ni-MH) battery

- The Ni-MH battery contains a strong alkaline electrolyte (pH 13.5). The electrolyte is absorbed in the cell plates, but it may leak in cases of damage to the high voltage battery. However, it would not be a large amount.



- Strong alkaline (pH 13.5) potassium hydroxide water solution is harmful to the human body. In cases where touching the electrolyte is unavoidable or there is a danger of it being touched, perform work wearing appropriate protective equipment such as rubber gloves and protective glasses.

2. Lithium ion (Li-ion) battery

- The Li-ion battery electrolyte, mainly consists of carbonate ester, is a flammable organic electrolyte. The electrolyte is absorbed into the electrodes and the separators. It may leak in cases of damage to the high voltage battery, but it would not be a large amount.
- Electrolyte will quickly evaporate if leaked from the battery cell.



- The flammable organic electrolyte which primarily contains carbonate ester is harmful to the human body. In case of contact with the electrolyte, it may irritate the eyes, nose, throat and skin. In case of contact with the smoke or vapor from leaked electrolyte or a burning battery, it may irritate the eyes, nose or throat. To avoid injury caused by coming in contact with the electrolyte or the vapor, wear appropriate protective equipment such as rubber gloves, safety goggles, protective mask or SCBA when there is a risk of touching electrolyte.
- If the electrolyte is spilled, keep it away from fire and ensure the area is well ventilated. Absorb the electrolyte with a piece of cloth or equivalent absorbent material, and keep it in an airtight container for proper disposal.

48V Battery Electrolyte

- A Li-ion battery is used for the 48V battery.

- The Li-ion battery electrolyte, mainly consisted of carbonate ester, is a flammable organic electrolyte. The electrolyte is absorbed into the electrodes and the separators. It may leak in case of damages to the 48V battery, but it would not be a large amount.
- Electrolyte will quickly evaporate if leaked from the battery cell.



- The flammable organic electrolyte which primarily contains carbonate ester is harmful to the human body. In case of contact with the electrolyte, it may irritate the eyes, nose, throat and skin. In case of contact with the smoke or vapor from leaked electrolyte or a burning battery, it may irritate the eyes, nose or throat. To avoid injury caused by coming in contact with the electrolyte or the vapor, wear appropriate protective equipment such as rubber gloves, safety goggles, protective mask or SCBA when there is a risk of touching electrolyte.
- If the electrolyte is spilled, keep it away from fire and ensure the area is well ventilated. Absorb the electrolyte with a piece of cloth or equivalent absorbent material, and keep it in an airtight container for proper disposal.

Vehicle with High Voltage Battery

- There are 2 types of high voltage battery; the nickel-metal hydride type and the lithium ion type.

1. Nickel-metal hydride (Ni-MH) battery

- The Ni-MH battery contains a strong alkaline electrolyte (pH 13.5). The electrolyte is absorbed in the cell plates, but it may leak in cases of damage to the high voltage battery. However, it would not be a large amount.
- Electrolyte leakage from the HV battery pack is unlikely considering the battery construction and the amount of electrolyte inside the module.



- Strong alkaline electrolyte (pH 13.5) is harmful to the human body. To avoid injury by coming in contact with the electrolyte, wear appropriate protective equipment such as rubber gloves and safety goggles when there is a risk of touching electrolyte.

2. Lithium ion (Li-ion) battery

- The Li-ion battery electrolyte, mainly consists of carbonate ester, is a flammable organic electrolyte. The electrolyte is absorbed into the electrodes and the separators. It may leak in cases of damage to the high voltage battery, but it would not be a large amount.
- Electrolyte will quickly evaporate if leaked from the battery cell.



WARNING

- The flammable organic electrolyte which primarily contains carbonate ester is harmful to the human body. In case of contact with the electrolyte, it may irritate the eyes, nose, throat and skin. In case of contact with the smoke or vapor from leaked electrolyte or a burning battery, it may irritate the eyes, nose or throat. To avoid injury caused by coming in contact with the electrolyte or the vapor, wear appropriate protective equipment such as rubber gloves, safety goggles, protective mask or SCBA when there is a risk of touching electrolyte.
- If the electrolyte is spilled, keep it away from fire and ensure the area is well ventilated. Absorb the electrolyte with a piece of cloth or equivalent absorbent material, and keep it in an airtight container for proper disposal.

Traction Battery Coolant

- Traction battery coolant contains ethylene glycol for freezing temperature control and anticorrosion additives for preventing metal components from corroding.
- As coolant is used as the cooling method for the high voltage battery, a coolant leak in the high voltage section during an accident, malfunction, etc., could result in a short circuit or similar possibly leading to battery overheating and the emission of fumes. For this reason, a coolant which resists the flow of electricity is used for the cooling system of the traction battery.
- As the coolant is different to traditional engine coolant (pink colour), an orange colour is used in order to be the same as high voltage systems.

Vehicle with Solar Battery

- A strong alkaline (pH 13.5) potassium hydroxide water solution is used as the solar battery electrolyte. The electrolyte is soaked into non-woven fabric. However, if the solar battery is damaged in any way, it may leak. However, there is no risk of a mass leak.
- Electrolyte leakage from the solar battery is unlikely due to its construction and the amount of available electrolyte contained within the Ni-MH modules. Any spillage would not warrant a declaration as a hazardous material incident.



WARNING

- Strong alkaline electrolyte (pH 13.5) is harmful to the human body. To avoid injury by coming in contact with the electrolyte, wear appropriate protective equipment such as rubber gloves and safety goggles when there is a risk of touching electrolyte.

Vehicle with Urea Solution

- Urea solution equipped vehicles have a urea tank that stores urea solution (AdBlue).
- The urea solution (AdBlue) is a harmless noncombustible liquid. However, if the urea solution (AdBlue) is heated due to a fire, etc., it breaks down and may emit a harmful gas.



WARNING

- If you come in contact with smoke or vapor from a burning urea tank, it may irritate the eyes, nose or throat. To avoid injury by coming in contact with the smoke or vapor from a burning urea tank, wear appropriate protective equipment such as rubber gloves, safety goggles, a protective mask or SCBA when there is a risk of contacting the smoke or vapor.

Vehicle with Hydrogen Gas

- The FC stack coolant used to cool the FC stack, etc. is colourless and transparent and contains ethylene glycol in order to lower the freezing point.

Gas Leaks

- There are various types of gas used in vehicles. For example, there is nitrogen (N₂) gas used in gas filled dampers, refrigerant gas for air conditioners, and CNG, LPG and hydrogen gas.

Nitrogen (N₂) Gas

- Nitrogen (N₂) is used in gas filled dampers.
- The gas is colourless, odorless, and harmless.

Refrigerant Gas

- The refrigerant gas used in air conditioner is R-134a or R-1234yf.
- The gas is containing carbon and fluorine.
- The gas is colourless, odorless, and harmless.

Vehicle with CNG

- Compressed Natural Gas (CNG) is a flammable gas that mainly contains methane.
- The gas is colourless and harmless.
- The gas is infused with a smell so that a leak can be quickly detected.



WARNING

- If the sound of natural gas leaking (a loud hissing sound) can be heard when working on the vehicle, or if the smell of natural gas is present, immediately step away from the vehicle as there is a chance that the natural gas may ignite.

Vehicle with LPG

- Liquefied Petroleum Gas (LPG) is a flammable gas that mainly contains propane and butane.
- The gas is colourless and harmless.
- The gas is infused with a smell so that a leak can be quickly detected.



WARNING

- If the sound of LPG leaking (a loud hissing sound) can be heard when working on the vehicle, or if the smell of LPG is present, immediately step away from the vehicle as there is a chance that the LPG may ignite.

Vehicle with Hydrogen Gas

- Hydrogen gas is a flammable gas.
- The gas is colourless, odorless, and harmless.



WARNING

- If the sound of hydrogen leaking (a loud hissing sound) can be heard when working on the vehicle, or if the hydrogen concentration around the vehicle exceeds 1% when measured with a hydrogen concentration detector, immediately step away from the vehicle as there is a chance that the hydrogen gas may ignite.

Emergency Response Key Points

- Procedures and points to be noted when handling TOYOTA vehicles during emergency response are provided in this section.
- With regards to the pictograms used, refer to chapter 10. Explanation of pictograms used (P156)

Fire

- During the initial attack on a fire, extinguish the fire with copious amounts of water. This will also cool down the vehicle.



- Plastic and other components will generate toxic gases when they melt. Wear appropriate protective equipment such as a protective mask when extinguishing a fire.

Fire Extinguisher

- Water has been proven to be a suitable extinguishing agent.
- Also use a fire extinguisher suitable for flammable liquid fires (burning of petrol, grease, oil, etc.) and electrical fires (burning of electrical wiring, electric devices, etc.) as well as general fires (burning of solid objects, etc.).

Vehicle with High Voltage Battery

- Hybrid vehicles (HEV), plug-in hybrid vehicles (PHEV), electric vehicles (BEV) and fuel cell vehicles (FCEV) are equipped with a high voltage battery.
- Battery fires should be extinguished by directing the smoke and flame emissions away from the vehicle.
- Extinguish the fire with copious amounts of water to cool down the high voltage battery.
- Water applied directly to the battery cells increases the cooling effect. Open a door or break the glass to extinguish the fire.
- Damaged cells in high-voltage batteries can lead to thermal runaway and reignition. To prevent thermal runaway and reignition, rescuers need to be aware of the risk of residual energy. The main cause of thermal runaway is a short circuit in a high-voltage battery cell and the resulting increase in the internal temperature of the cell. If thermal runaway occurs in one or more cells, it can spread to other cells in a domino effect.
- After an accident, energy remains within the undamaged high-voltage battery cells.
- Refer to the Rescue Sheet for each model for the high voltage battery location.



- To avoid serious injury or death from severe burns or electric shock, never breach or remove the high voltage battery assembly cover under any circumstances, including fire.
- Do not attempt to puncture the high-voltage battery and pour water on it.
- If only a small amount of water is used to extinguish a fire, a short circuit may occur in the high voltage battery, causing the fire to reignite.



- It is recommended to allow the high voltage battery to burn itself out if it is judged that it is difficult to apply copious amounts of water to the high voltage battery.

Vehicle with Lithium ion (Li-ion) Battery



- Burning Li-ion batteries may irritate the eyes, nose or throat. In case of contact with the vapor from the electrolyte, it may irritate the nose or throat. To avoid injury by coming in contact with the electrolyte or vapor, wear appropriate protective equipment such as rubber gloves, safety goggles, protective mask or SCBA when there is a risk of touching electrolyte.
- To prevent reignition, use a thermal imaging camera to ensure that the high-voltage battery is completely cooled after extinguishing the fire.

Vehicle with Urea Solution

- Urea solution equipped vehicles have a urea tank that stores urea solution (AdBlue).



- The urea solution (AdBlue) is noncombustible. However, if the urea solution (AdBlue) is heated due to a fire, etc., it breaks down and may emit a harmful gas. If you come in contact with smoke or vapor from a burning urea tank, it may irritate the eyes, nose or throat.
- To avoid injury by coming in contact with the smoke or vapor from a burning urea tank, wear appropriate protective equipment such as rubber gloves, safety goggles, a protective mask or SCBA when there is a risk of contacting the smoke or vapor.

Vehicle with Hydrogen Gas

- Fuel cell vehicles (FCEV) carry compressed hydrogen gas.
- When dousing the vehicle, keep a distance of at least 10.0 meters (32.8 feet) in case of hydrogen igniting.
- Use larger amounts of water particularly on the vehicle's rear underfloor to cool the area where the hydrogen tanks are located.
- If the hydrogen is on fire, extinguishing the hydrogen flame completely could cause unburned hydrogen to accumulate and lead to a secondary explosion. Therefore, spray water to prevent the flame from spreading to surrounding areas, then wait for the hydrogen flame to naturally die down (burn itself out).
- In order to prevent an explosion when the temperature of the hydrogen reaches abnormal levels in case of a vehicle fire, the thermal pressure relief devices (TPRD) installed on the hydrogen tanks open when they exceed approximately 110°C (230°F), and the hydrogen inside the tank is released outside of the vehicle.
- A pure hydrogen fire is colourless and is not visible. However, in a vehicle fire, other flammable materials will also burn, allowing the fire to be visible.

Fire

- The temperature of a hydrogen fire itself is very high, but the amount of heat that radiates from the flame is small. It is unique in that it is difficult to feel the heat even in close proximity.

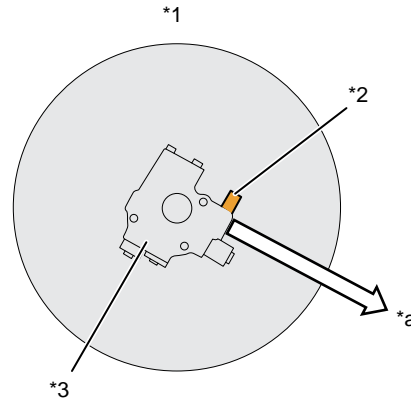

*1	Hydrogen Tank	*2	Thermal Pressure Relief Device (TPRD)	*3	Tank Valve
*a	Jet Angle				



WARNING

- Hydrogen gas is colourless, odorless and flammable.
- Compared to petrol or natural gas, hydrogen gas can ignite in a wide range of concentrations (4 to 74.5%). If the sound of hydrogen leaking (a loud hissing sound) can be heard when working on the vehicle, or if the hydrogen concentration around the vehicle exceeds 1% when measured with a hydrogen concentration detector, immediately step away from the vehicle as there is a chance that the hydrogen gas may ignite.



NOTICE

- Depending on the model, multiple hydrogen tanks may be installed. For the detailed installation locations of hydrogen tanks for each model, refer to the Rescue Sheet for each model.

Emergency Response Key Points

- Procedures and points to be noted when handling TOYOTA vehicles during emergency response are provided in this section.

Submersion

- Pull the vehicle out of water as much as possible. Immobilise the vehicle (see page 27) and disable the vehicle (see page 57) before starting any operation.
- Refer to 4. Access to the occupants (P57) for rescue procedures.



NOTICE

- A short circuit due to electrical corrosion (wiring and circuit boards become corroded due to an electrochemical reaction with water) may cause a vehicle fire after some time has elapsed.
- To prevent a vehicle fire, avoid turning the ignition switch or power switch of a submerged vehicle to ACC or ON.

Vehicle with High Voltage Battery

- A partially or fully submerged hybrid vehicle (HEV), plug-in hybrid vehicles (PHEV), electric vehicle (BEV) or fuel cell vehicle (FCEV) does not have high voltage potential on the metal vehicle body, and is safe to touch.
- It is safe to enter the water as the vehicle and water have the same electrical potential.



WARNING

- Touching exposed orange high voltage power cables or high voltage components such as the high voltage battery may cause electrical shock due to a change in electrical potential.
- To prevent serious injury or death from severe burns or electric shock, avoid touching, cutting, or breaching any orange high voltage power cable or high voltage component. Wear appropriate protective equipment such as insulated gloves when there is a risk of touching high voltage power cables or a high voltage components.

Damaged Vehicle Handling Key Points

- Points to be noted when handling damaged vehicles are provided in this section.

Towing Damaged Vehicle

- Loading a vehicle onto a car carrier (flat bed trailer) is the preferred method of towing.
- Only the FF (Front-engine Front-wheel drive) vehicles are available to tow with rear wheels on the ground.
- If towing the vehicle with all four wheels on the ground is unavoidable, release the parking lock, move the shift lever to neutral (N), and unlock the steering wheel first. The vehicle can then be towed at a low speed (below 30 km/h) for a distance of up to 80 km in a forward direction. (*Except vehicles with a high voltage battery. See page130for details.)
- Refer to the illustrations on the following page for correct and incorrect methods of towing FF (Front-engine Front-wheel drive), FR (Front-engine Rear-wheel drive), MR (Mid-engine Rearwheel drive) and 4WD (Four Wheel Drive) vehicles.



WARNING

- When towing a vehicle with all four wheels on the ground, make sure the vehicle is in "Ignition-On" mode. If in "Off" mode, the steering wheel may lock, making the steering inoperative.
 - Vehicles equipped with the steer-by-wire system cannot be steered while the ignition switch is turned off because the steering wheel and the tires are in a free condition*.
- *The steering lock may be engaged in this condition.



NOTICE

- Exceeding the towing distance or speed limit when towing a vehicle with all four wheels on the ground or towing a vehicle with the vehicle facing backwards, may damage the transmission or transaxle.
- When the vehicle is equipped with a stop and start system, towing the vehicle with all four wheels on the ground may damage the system.

Parking Lock

- The parking lock can be released by moving the shift lever from park (P) to neutral (N) while pushing and holding the "lock release button" on the shift gate.

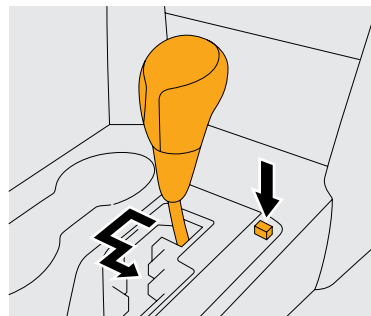

NOTICE

- The parking lock for vehicles equipped electric shift switches (vehicles with a P position switch) cannot be released while the 12 V negative (-) battery terminal is disconnected. When moving the vehicle, use a jack, etc.

Steering Wheel Lock

- The steering wheel can be unlocked by pushing the engine/power switch until in “Ignition-On” mode, or turning the ignition switch to any position other than “LOCK”.
- When it is difficult to release the lock, turn the steering wheel in either direction while pushing the engine/power switch or turning the key.

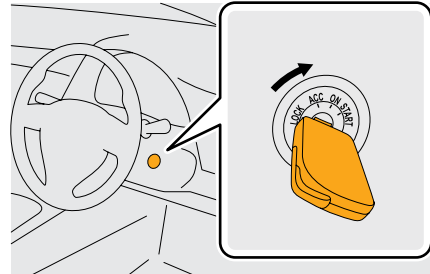

NOTICE

- When a vehicle is equipped with the electrical key transmitter system, the steering wheel cannot be unlocked if the negative (-) terminal of the 12 V battery is disconnected. Use wheel dollies or similar equipment when moving the vehicle.

Steer-by-Wire System

- The steer-by-wire system is a power steering system without a mechanical link between the steering wheel and the tires via intermediate shaft.
- It consists of a steering control actuator (STA) with an STA MCU and a worm and wheel reducer installed in the steering wheel and steering column, and steering control actuator (SCA) with an SCA MCU installed in the rack-parallel power steering gear. The STA and SCA are connected via CAN communication.
- When the ignition switch is turned off, the steering wheel and the tires will be in a free condition.

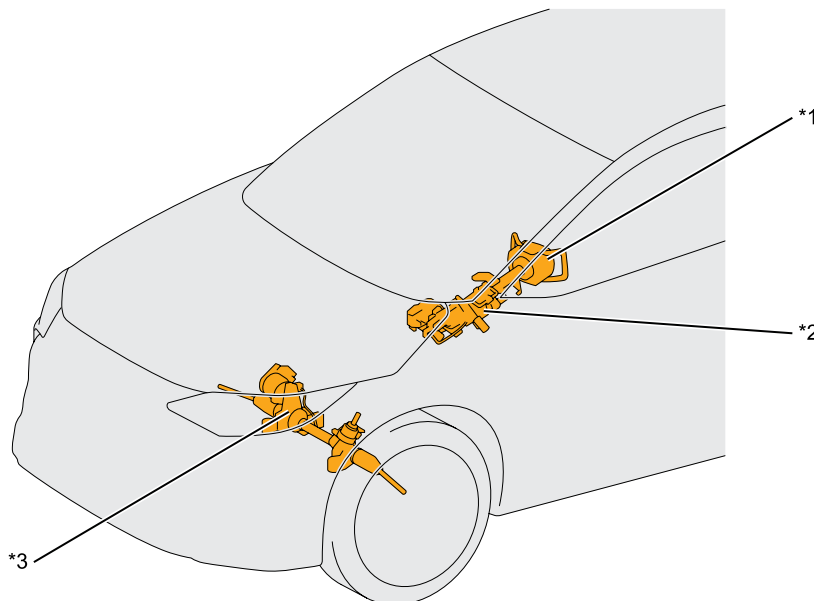

*1	Steering Wheel	*2	Steering Torque Actuator
*3	Steering Control Actuator	-	-

Precautions for FF (Front-engine Front-wheel drive) vehicle

- Tow the vehicle with the front wheels or all four wheels off the ground.

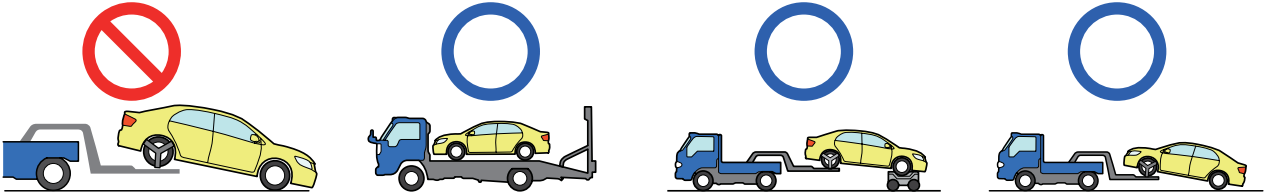

Precautions for FR (Front-engine Rear-wheel drive), MR (Mid-engine Rear-wheel drive) and 4WD (Four Wheel Drive) vehicles

- Tow the vehicle with all four wheels off the ground.

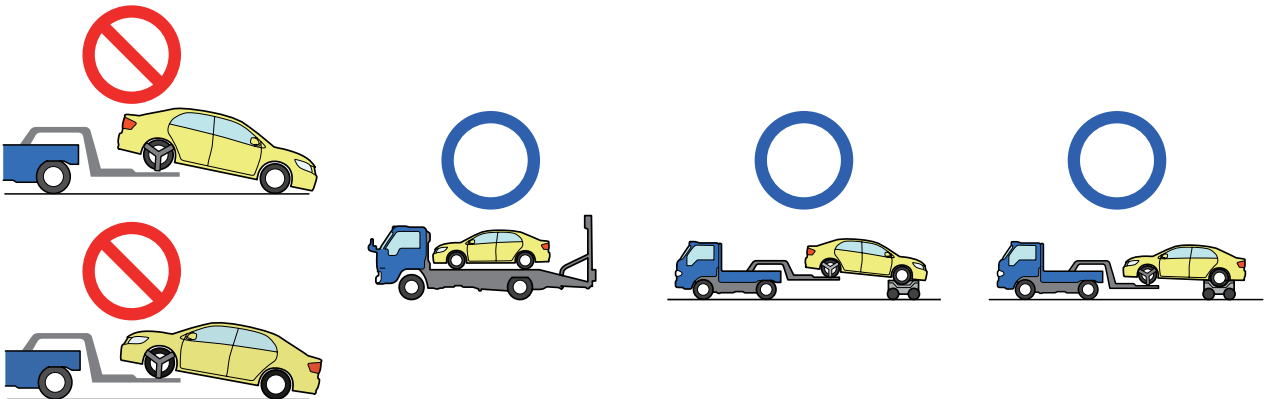

Vehicle with High Voltage Battery

- Make sure the negative (-) terminal of the 12 V battery is disconnected, then load the vehicle onto a car carrier (flat bed trailer).
- If towing the vehicle with all four wheels on the ground is unavoidable, only tow it for a short distance (such as to a car carrier (flat bed trailer)) in a forward direction at a low speed (below 30 km/h (18 mph)).
- Refer to the above illustrations for correct and incorrect methods of towing FF, FR and 4WD vehicles.



WARNING

- Hybrid vehicles (HEV), plug-in hybrid vehicles (PHEV), electric vehicles (BEV) and fuel cell vehicles (FCEV) are equipped with a high voltage electrical system (120 to 800 V).
- To prevent serious injury or death from severe burns or electric shock, avoid touching, cutting, or breaching any orange high voltage power cable or high voltage component. Wear appropriate protective equipment such as insulated gloves when there is a risk of touching high voltage power cables or high voltage components.



NOTICE

- If hybrid vehicles (HEV), plug-in hybrid vehicles (PHEV), electric vehicles (BEV) or fuel cell vehicles (FCEV) are towed with the drive wheels on the ground, it could have adverse effects on the high voltage system and damage it.

Storing a Damaged Vehicle

- Drain petrol, oil and other fluids, then disconnect the negative (-) terminal of the 12 V battery before storing a damaged vehicle.

Submerged Vehicle

- In addition to the normal procedures, remove the water from the vehicle.



NOTICE

- A vehicle that has been submerged in water poses a threat of vehicle fire after some time for possible short circuits due to electrical corrosion (wiring and circuit boards to corrode in an electrochemical reaction with water). To store a vehicle that has been submerged in water, choose a well-ventilated place at least 15 meters (49.2 feet) away from other objects.
- To prevent a vehicle fire, avoid turning the ignition switch or power switch of a submerged vehicle to ACC or ON.

Vehicle with High Voltage Battery

- In addition to the normal procedures, remove the service plug or interlock connector from the high voltage battery before storing a damaged vehicle.



WARNING

- The service plug is a high voltage component. Touching it without appropriate protective equipment may result in serious injury or death from severe burns and electric shock from the high voltage electrical system. Wear appropriate protective equipment such as insulated gloves when touching the service plug.
- The high voltage battery is still charged with high voltage electricity even after the vehicle is shut off, disabled (see page 57) and the service plug or interlock connector is removed from the high voltage battery.
- To prevent serious injury or death from severe burns or electric shock, avoid touching, cutting, or breaching any orange high voltage power cable or high voltage component. Wear appropriate protective equipment such as insulated gloves when there is a risk of touching high voltage power cables or high voltage components.
- When the person(s) in charge of handling the damaged vehicle is away from the vehicle, other person(s) may accidentally touch the vehicle and be electrocuted, resulting in severe injury or death. To avoid this danger, display a "HIGH VOLTAGE DO NOT TOUCH" sign to warn others (print and use page 14 of this guide).



NOTICE

- A high voltage battery may cause a vehicle fire after some time for possible short circuits inside due to the impact of collision or electrical corrosion. To store a vehicle equipped with a high voltage battery, choose a well-ventilated place at least 15 meters (49.2 feet) away from other objects.

- To prevent the recurrence of high-voltage battery fires, perform the following steps (1 to 3).

1. Completely shut off the vehicle (see 57).
2. Remove the service plug or interlock connector from the high voltage battery.
3. Discharge the high-voltage battery.
 - (1) Place the high-voltage battery in a saltwater immersion container.
 - (2) Add water until the high-voltage battery is completely submerged.
 - (3) In a bucket of water, add the amount of salt required to make the water in the saltwater immersion container a 1% solution, and then mix well.
 - (4) Pour the saltwater solution into the saltwater immersion container.
 - (5) Leave as is for 24 hours or more until the discharge is completed.



- If gas bubbles are present, do not cover with a lid as the discharge may still be continuing.
- Electrolysis may generate large amounts of combustible hydrogen gas in the salt water. Make sure to perform the discharge operation without a lid.
- To ensure that all energy is discharged, make sure to let the discharge operation continue for at least 24 hours.
- During the discharge operation, there is a chance that a person could unknowingly touch the high-voltage battery, possibly resulting in serious injury or death due to electric shock. (P.133)

Person in charge:

Scheduled discharge completion date:

Discharge start date:

DO NOT TOUCH!
(DISCHARGE BEING PERFORMED)

DO NOT TOUCH!
(DISCHARGE BEING PERFORMED)

Discharge start date:

Scheduled discharge completion date:

Person in charge:

Vehicle with Hydrogen Gas

- In addition to the normal procedures, remove the service plug, etc. cutting off high voltage from the fuel cell (FC stack) before storing the vehicle.



WARNING

- Service plug, etc. cutting off high voltage is a high voltage component. Touching these without wearing protective equipment may result in serious injury or death from severe burns or electric shock. Wear appropriate protective equipment such as insulated gloves when touching high voltage components.
- To prevent serious injury or death from severe burns or electric shock, avoid touching, cutting, or breaching any orange high voltage power cable or high voltage component. Wear appropriate protective equipment such as insulated gloves when there is a risk of touching high voltage power cables or high voltage components.
- When the person(s) in charge of handling the damaged vehicle are away from the vehicle and someone else accidentally approaches or touches the vehicle, death or serious injury may occur due to electrocution, a rupture, an explosion or fire. To avoid this danger, display "HIGH VOLTAGE DO NOT TOUCH" and "HIGH PRESSURE GAS DO NOT TOUCH" signs to warn others (print and use page 14 and 16 of this guide).



NOTICE

- Vehicles that are equipped with hydrogen gas may leak due to damage incurred during an accident. The remaining hydrogen may ignite causing a fire or explosion. Therefore, when storing a vehicle equipped with hydrogen gas, place it in a well ventilated area 15 meters or more away from other items and leave the windows or doors open.

Vehicle with Sub-battery



NOTICE

- Due to the impact during the collision and electrolytic corrosion of the sub-battery, a short circuit may occur internally causing a fire to occur after a certain amount of time elapses. When storing a vehicle equipped with a sub-battery, place it in a well ventilated area 15 meters or more away from other items.

Components Requiring Special Attention

- The construction and functions of components requiring special attention during emergency response are described in this section.

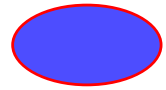

SRS Airbags

- When a vehicle receives a strong impact that can cause serious injury to the occupants, the SRS airbags deploy and the seatbelts restrain the occupants to help reduce impact to the body. Refer to the Rescue Sheet for each model for the type and location of each SRS airbag.

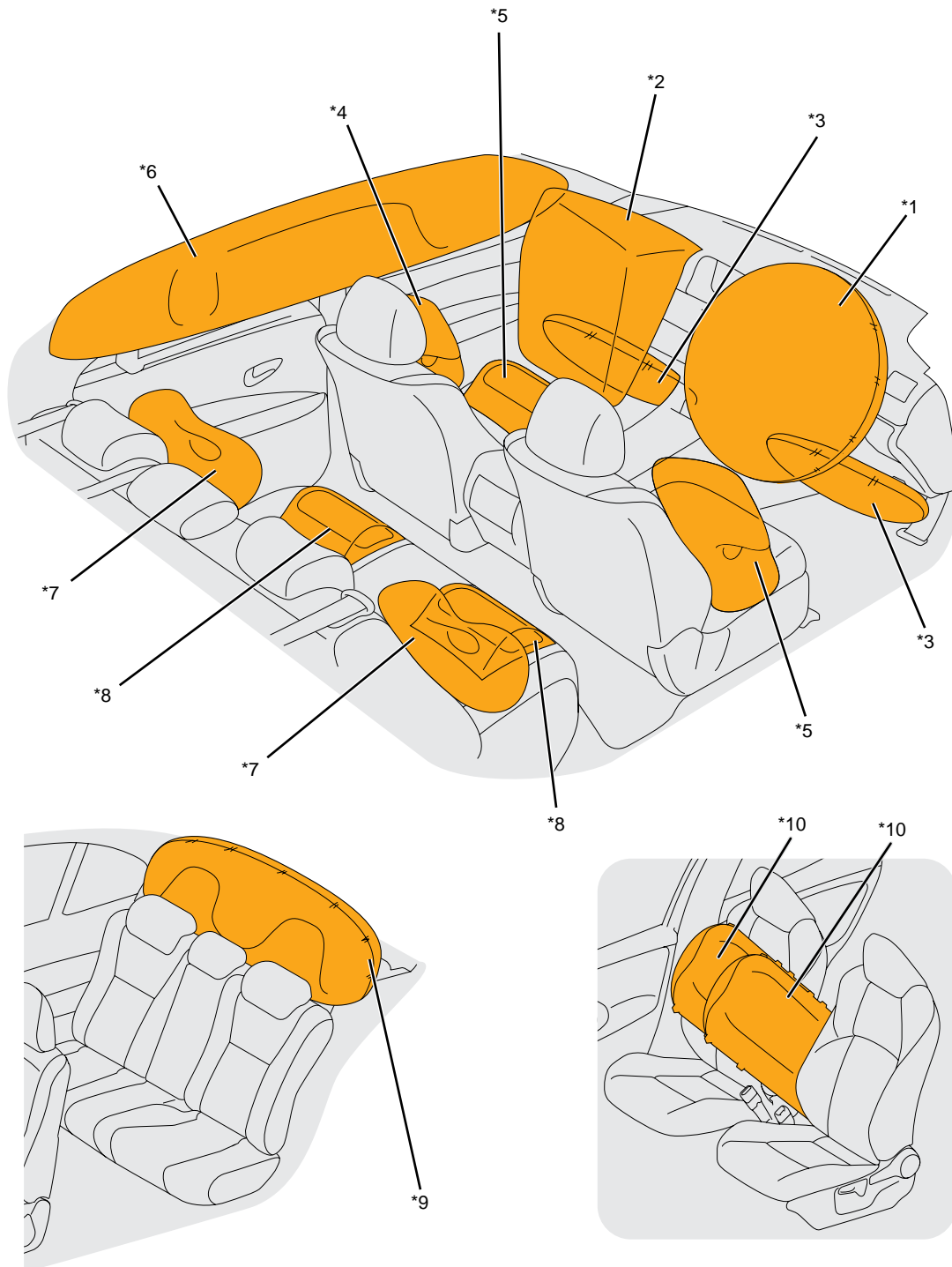
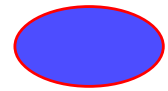

*1	Driver Airbag	*2	Passenger Airbag
*3	Front Knee Airbag	*4	Front Seat Side Airbag
*5	Front Seat Cushion Airbag	*6	Curtain Shield Airbag
*7	Rear Seat Side Airbag	*8	Rear Seat Cushion Airbag
*9	Back Window Curtain Shield Airbag	*10	Front Seat Centre Airbag



- The SRS airbags consist of an inflator (explosive), a bag and other components and are non-serviceable.
- When an airbag sensor detects a strong impact, an ignition signal is sent to an inflator. When the inflator is ignited, gas is generated to inflate a bag, helping reduce the impact to an occupant.



WARNING

- The SRS airbag may remain powered for up to 90 seconds after the vehicle is shut off and disabled (see page 57). Wait at least 90 seconds before starting any operation. Failure to shut off and disable the vehicle before emergency response procedures are performed may result in serious injury or death from unintentional deployment of the SRS airbag.
- Depending on the circumstances surrounding a collision, such as vehicle speed, point of impact, occupant detection etc., SRS airbags will not always be deployed. If an inflator of the undeployed SRS airbag is breached, the powder inside the inflator may ignite resulting in unintentional SRS airbag deployment. To prevent serious injury or death from unintentional SRS airbag deployment, avoid breaching the inflators.
- Immediately after an SRS airbag is deployed, the components are extremely hot and may cause burns if touched.
- If an SRS airbag deploys with all doors and windows closed, inflation gas may cause breathing difficulty.
- If residue that is produced during SRS airbag deployment comes in contact with skin, rinse it off immediately to prevent skin irritation.

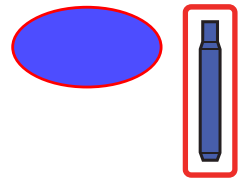

Driver Airbag

- A driver airbag is mounted in the steering wheel pad and activated in the event of a frontal collision.

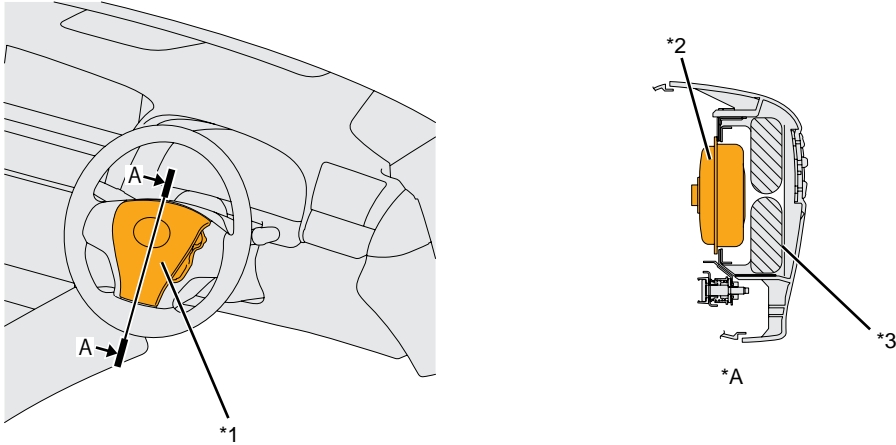

*A	A-A Cross Section		
*1	Driver Airbag	*2	Inflator
*3	Bag		

Passenger Airbag

- A passenger airbag is mounted in the upper portion of the passenger side instrument panel and activated in the event of a frontal collision.

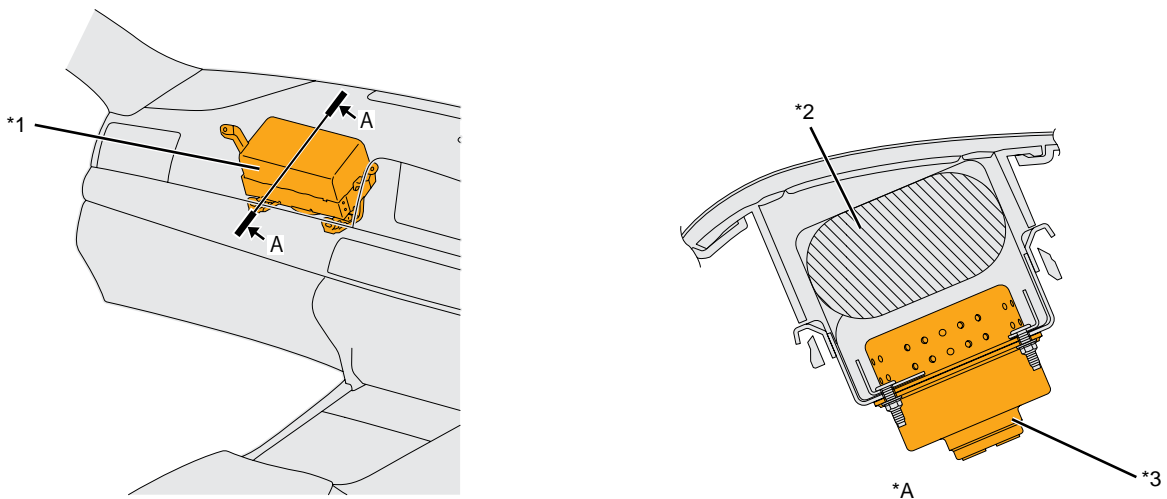

*A	A-A Cross Section		
*1	Passenger Airbag	*2	Bag
*3	Inflator		

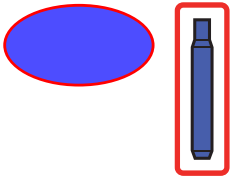

Front Knee Airbag

- Front knee airbags are mounted in the lower portion of the instrument panel on the driver side and the front passenger side, and activated in the event of a frontal collision.

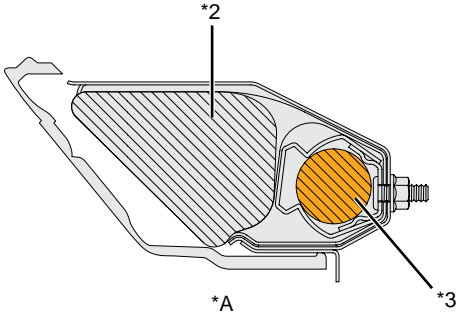
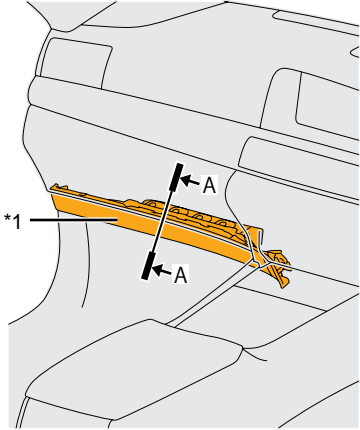

*A	A-A Cross Section		
*1	Front Knee Airbag	*2	Bag
*3	Inflator		

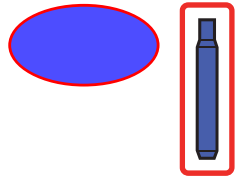

Front Seat Side Airbag

- Front seat side airbags are mounted in the seat frame of the driver seat and the front passenger seat, and activated in the event of a side collision.
- In some vehicles, front seat side airbags are also activated in the event of a frontal collision.

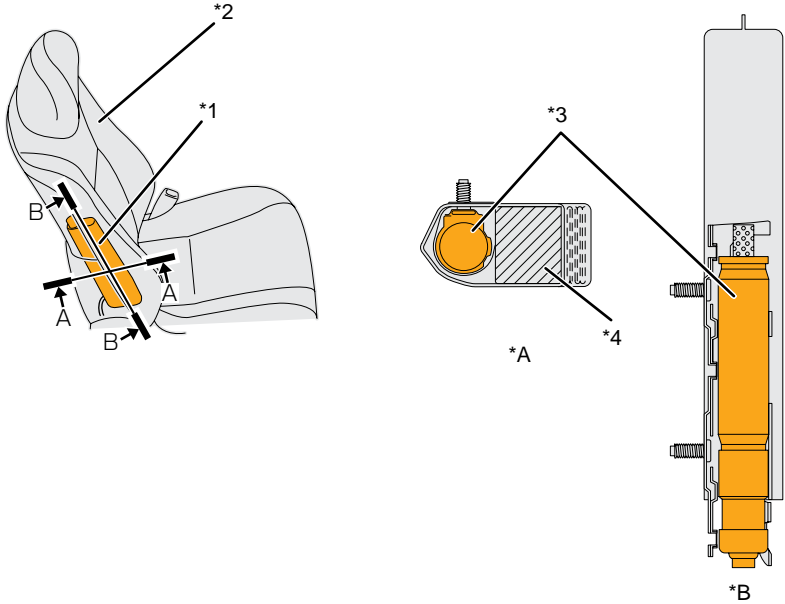

*A	A-A Cross Section	*B	B-B Cross Section
*1	Front Seat Side Airbag	*2	Seat Frame
*3	Inflator	*4	Bag

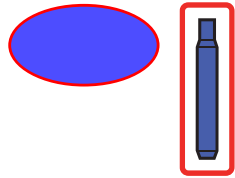

Front Seat Centre Airbag

- Front seat centre airbags are mounted in the seat frame of the driver seat and the front passenger seat, and activated in the event of a side collision.

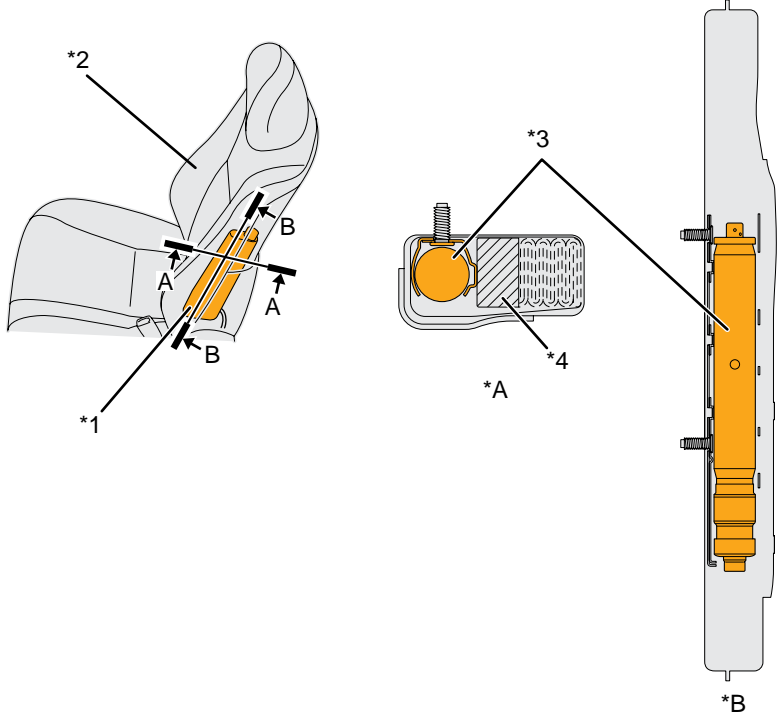

*A	A-A Cross Section	*B	B-B Cross Section
*1	Front Seat Centre Airbag	*2	Seat Frame
*3	Inflator	*4	Bag

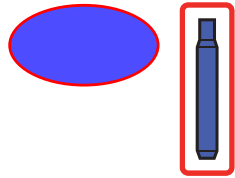

Front Seat Cushion Airbag

- Front seat cushion airbags are mounted in the seat cushion of the driver seat and the front passenger seat, and activated in the event of a frontal collision.

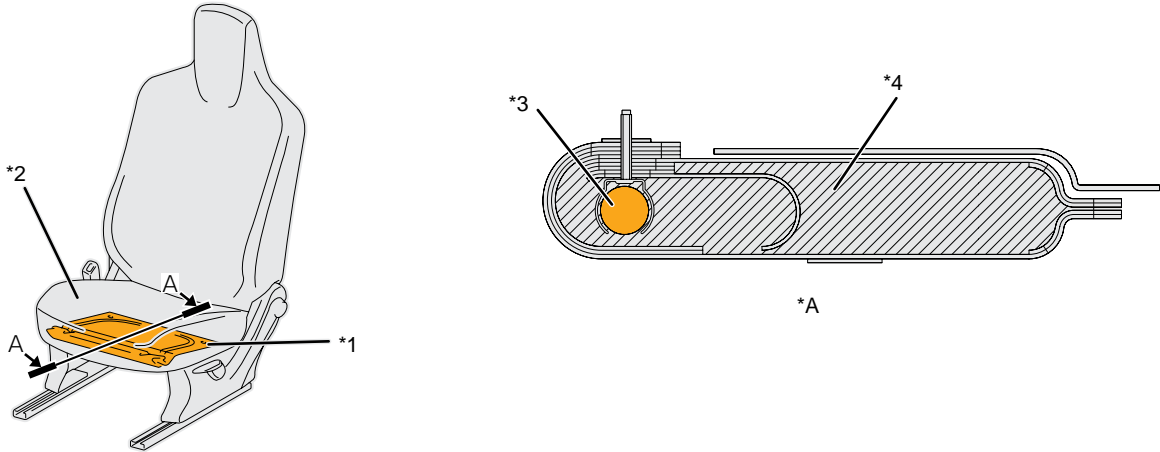

*A	A-A Cross Section		
*1	Front Seat Cushion Airbag	*2	Seat Cushion
*3	Inflator	*4	Bag

Curtain Shield Airbag

- Curtain shield airbags are mounted in the area between the front pillar and rear pillar on the driver side and the front passenger side, and activated in the event of a side collision.
- In some vehicles, curtain shield airbags are also activated in the event of a frontal collision.

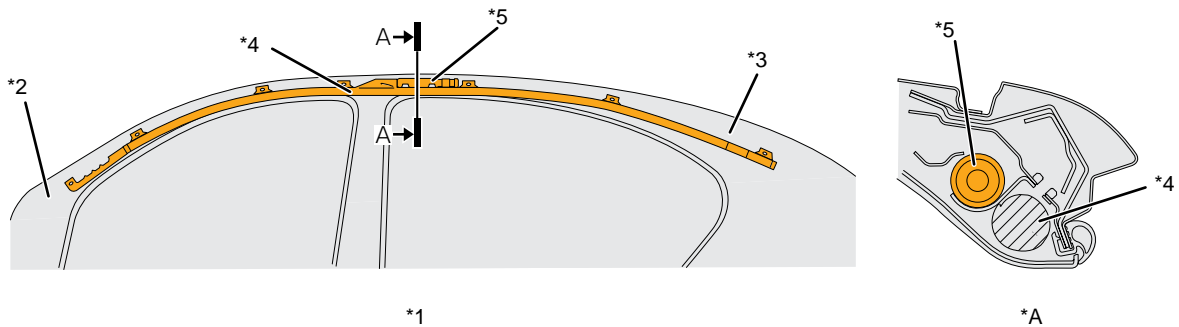

*A	A-A Cross Section		
*1	Curtain Shield Airbag	*2	Front Pillar
*3	Rear Pillar	*4	Bag
*5	Inflator		

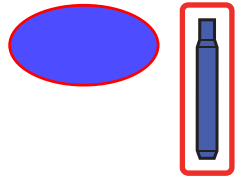

Rear Seat Side Airbag

- Rear seat side airbags are mounted in the sides of the rear seat frame or rear seat side garnish and activated in the event of a side collision.
- In some vehicles, rear seat side airbags are also activated in the event of a frontal collision.

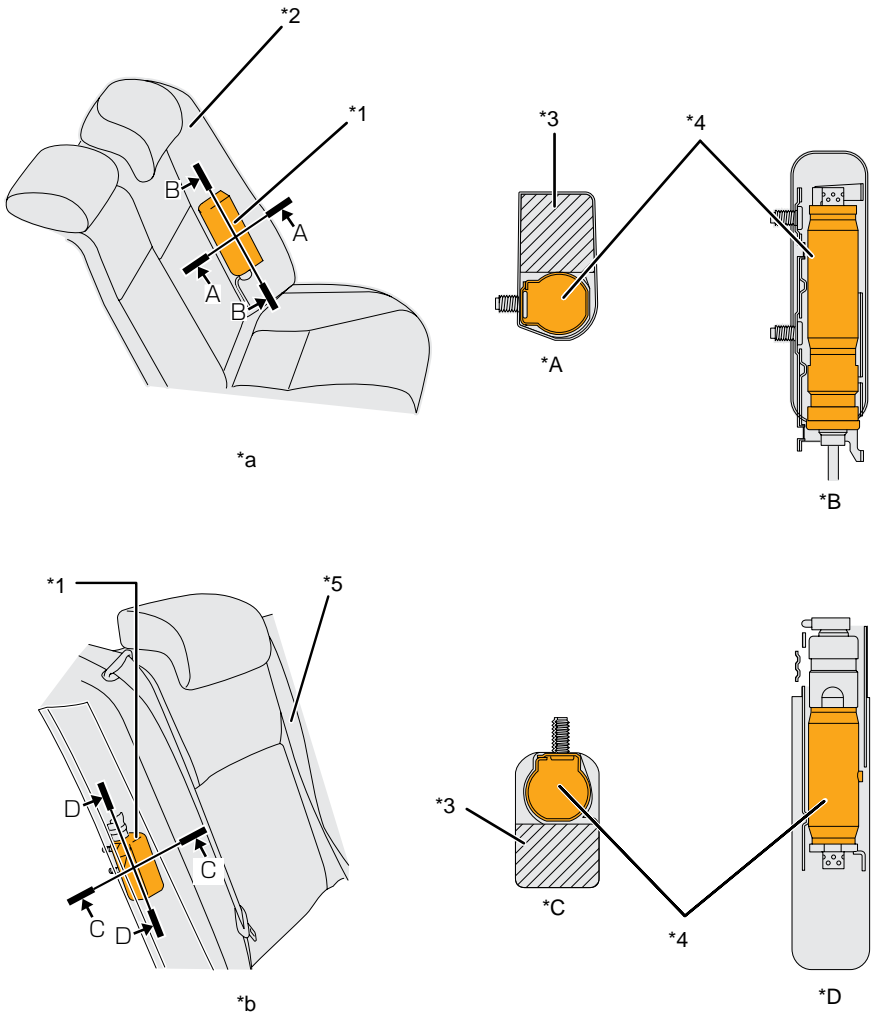

*A	A-A Cross Section	*B	B-B Cross Section
*C	C-C Cross Section	*D	D-D Cross Section
*1	Rear Seat Side Airbag	*2	Rear Seat Frame
*3	Bag	*4	Inflator
*5	Rear Seat		
*a	Mounted in the Side of the Rear Seat Frame	*b	Mounted in the Rear Seat Side Garnish

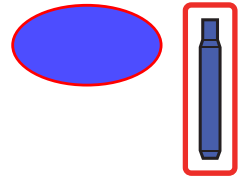

Rear Seat Cushion Airbag

■ Rear seat cushion airbags are mounted in the rear seat cushions and activated in the event of a frontal collision.

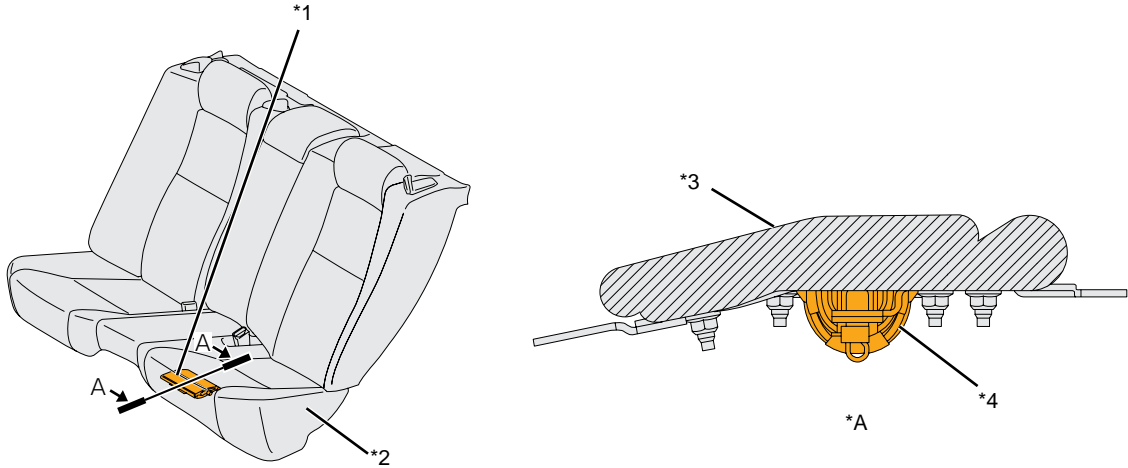

*A	A-A Cross Section	
*1	Rear Seat Cushion Airbag	*2 Rear Seat Cushion
*3	Bag	*4 Inflator

Back Window Curtain Shield Airbag

■ A back window curtain shield airbag is mounted in the upper portion of the rear back panel (back door mounting section) and activated in the event of a rear collision.

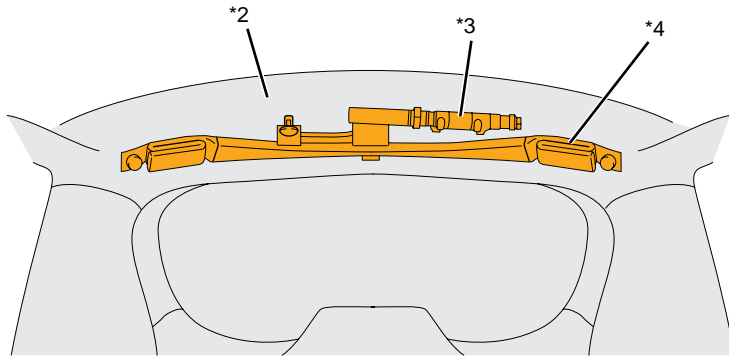

*1

*1	Back Window Curtain Shield Airbag	*2 Rear Back Panel
*3	Inflator	*4 Bag



Automatic rollover protection system

- If the vehicle rolls over, an automatic rollover protection system is deployed to ensure space between the ground and vehicle.
- The automatic rollover protection system is a non-disassembly type and is composed of parts such as the squib, ratchet, and centre profile.
- When the airbag ECU detects a vehicle collision or rollover, the squib is ignited and the automatic rollover protection system begins operating. When the squib is ignited, the centre profile and ratchet are unlocked, and the centre profile moves upward.

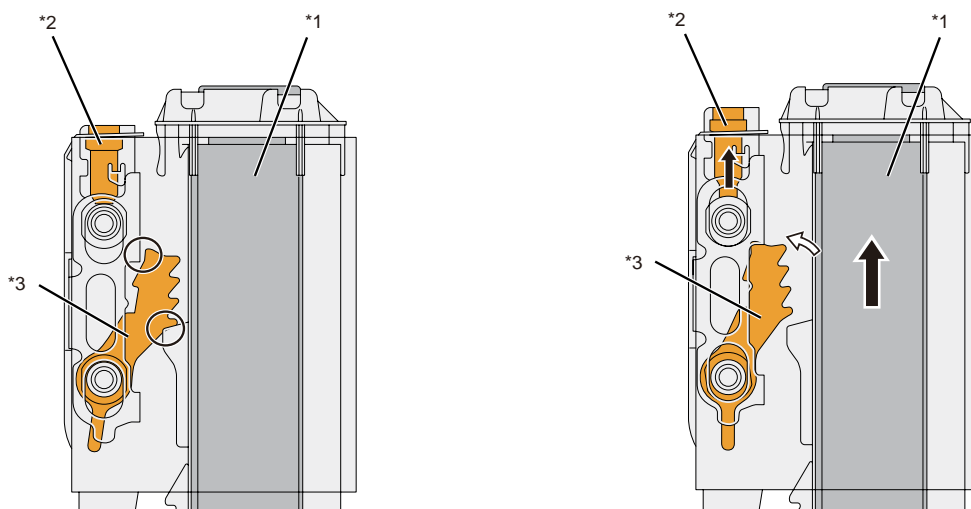
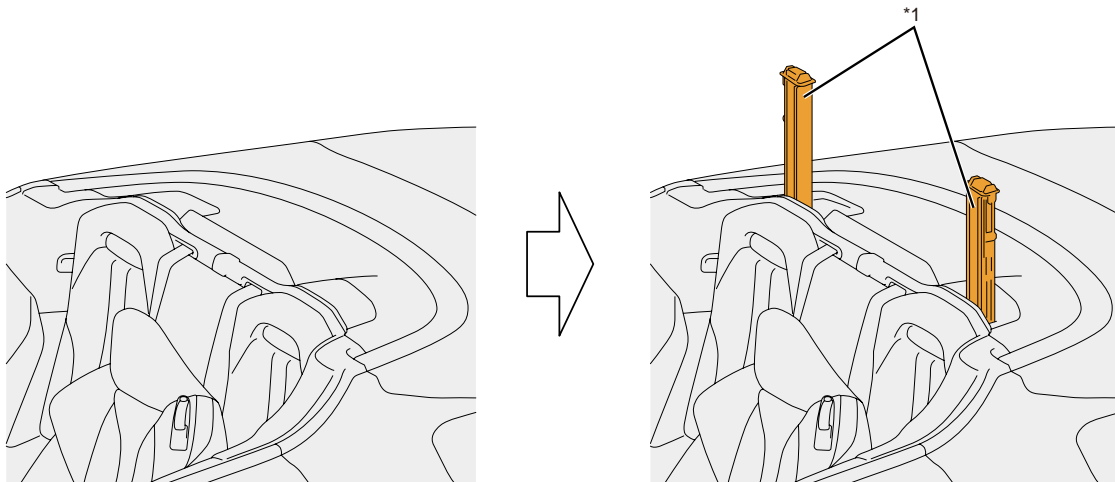

*1	Centre Profile	*2	Squib
*3	Ratchet		

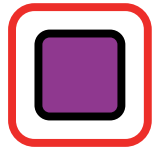

Seat belt pretensioner

- When the vehicle receives a strong impact from the front, the seatbelts are retracted to optimally restrain the occupants.
- In some vehicles, seat belt pretensioners are also activated in the event of a side collision.

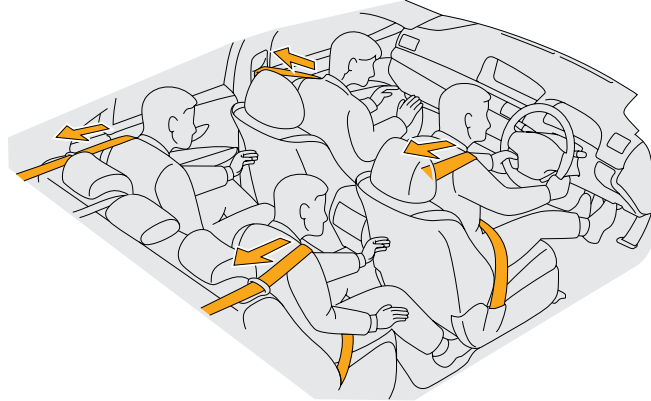

- A pretensioner mechanism is built into the retractor of each of the front seatbelts. Some models have a seat belt pretensioner mechanism in the rear seatbelts.
- The pretensioner mechanism consists of a gas generator, a piston and a pinion gear.
- When an airbag sensor detects a strong impact, an ignition signal is sent to a gas generator. When the gas generator is ignited, gas is generated and its pressure rotates a gear that retracts the seatbelt.

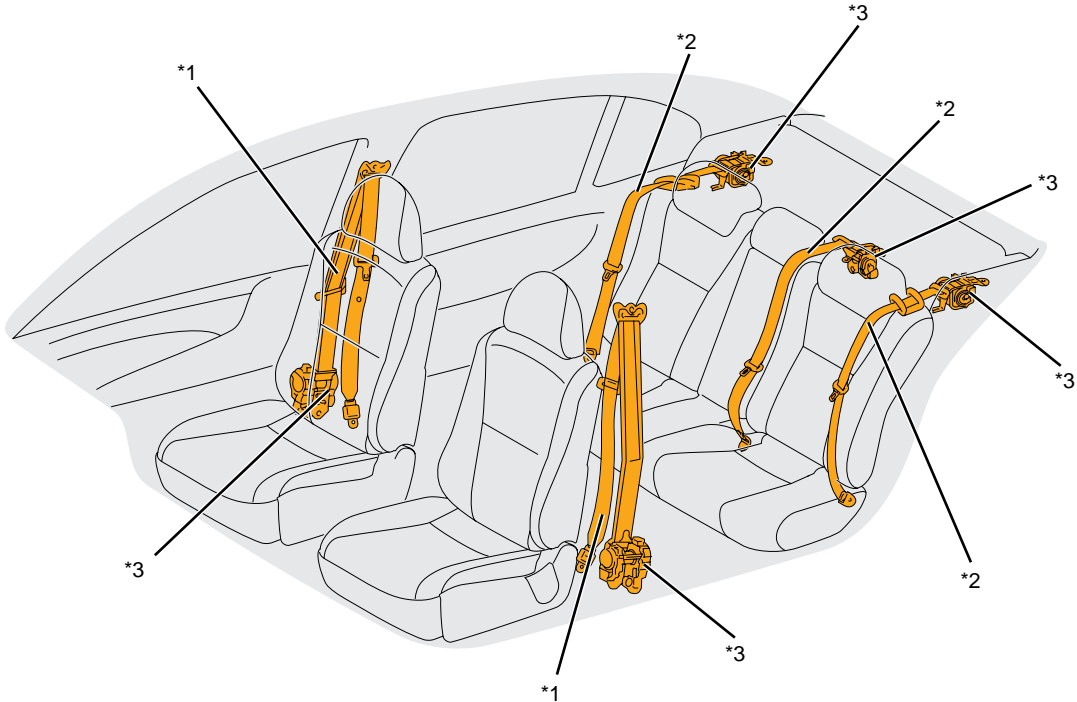

*1	Front Seatbelt	*2	Rear Seatbelt
*3	Retractor		

■ Refer to the Rescue Sheet for each model for locations of the seatbelt pretensioners.



- The seat belt pretensioners may remain powered for up to 90 seconds after the vehicle is shut off and disabled (see page 57). Wait at least 90 seconds before starting any operation. Failure to shut off and disable the vehicle before emergency response procedures are performed may result in serious injury or death from unintentional actuation of the seat belt pretensioner
- To prevent serious injury or death from unintentional seat belt pretensioners actuation, avoid breaching the seat belt pretensioners.

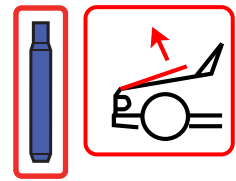

Pedestrian protection active system

- During a frontal collision, the pedestrian protection active system lifts the entire bonnet or the rear end, ensuring ample space inside the engine room and contributing to reduced collision impact to the head of pedestrians.
- When the sensor inside the front bumper detects a strong impact, an ignition signal is sent to the inflator. When the inflator is ignited, the piston inside the lifter is pushed up, lifting the bonnet.

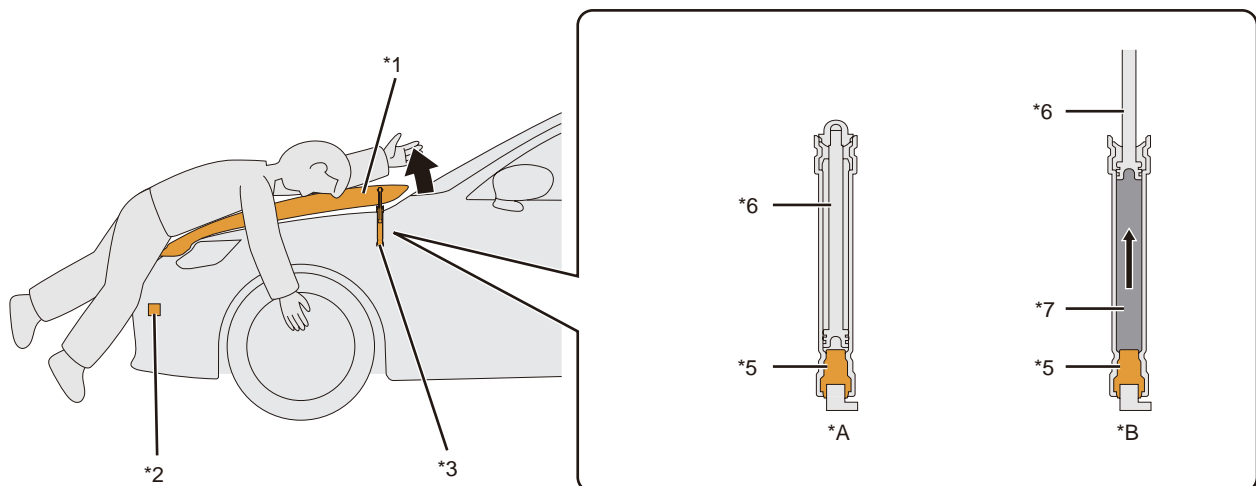
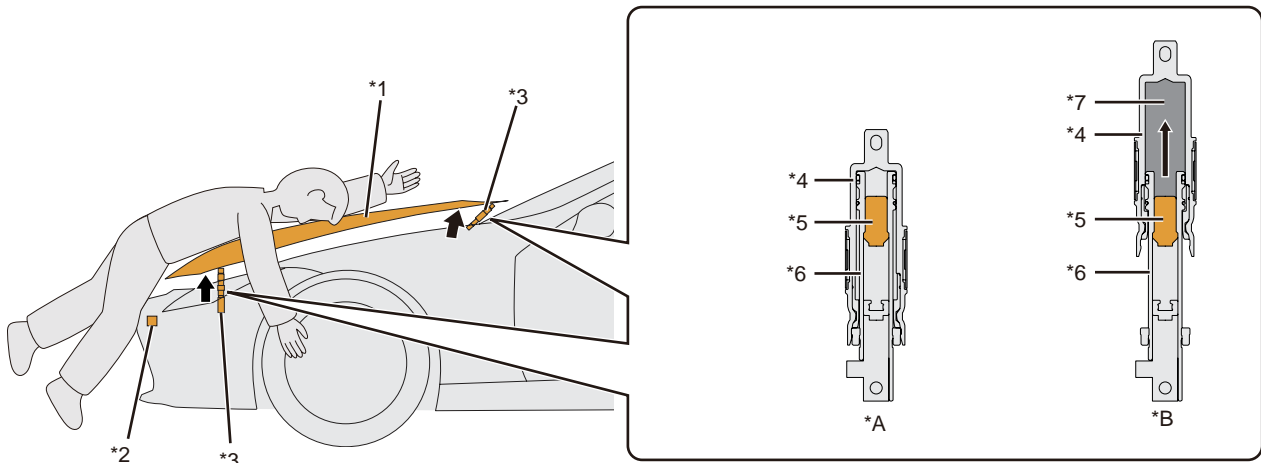

*A	Before Activation	*B	After Activation
*1	Bonnet	*2	Sensor
*3	Lifter	*4	Case
*5	Inflator	*6	Piston
*7	Gas		

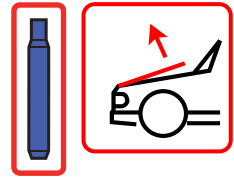

WARNING

- The pedestrian protection active system may remain powered for up to 90 seconds after the vehicle is shut off and disabled (see page 57). Wait at least 90 seconds before starting any operation. Failure to shut off and disable the vehicle before emergency response procedures are performed may result in serious injury or death from unintentional actuation of the pedestrian protection active system.
- If a lifter is cut, the pedestrian protection active system inflator may unintentionally deploy. To prevent serious injury or death from unintentional pedestrian protection active system actuation, avoid breaching the lifters.
- If the bonnet release lever is pulled after the pedestrian protection active system is activated, the bonnet may rise more, possibly resulting in an injury.
- After the pedestrian protection active system is activated, the bonnet cannot be lowered by hand. If the bonnet is pushed down excessively, it may be deformed, possibly resulting in an injury.
- Immediately after the pedestrian protection active system is activated, the lifters are very hot and may cause burns if touched.

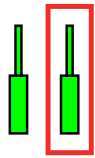

Gas strut / Preloaded spring

- Gas struts are used in various components, such as in the suspension (shock absorbers), engine bonnet stays, and for other various purposes. Nitrogen (N₂) gas is used in these dampers.
- Nitrogen (N₂) gas is colourless, odorless and harmless.
- Refer to the Rescue Sheet for each model for the location of these gas struts.



WARNING

- If a gas-filled damper is heated in an event of a vehicle fire, the damper may explode due to expanded nitrogen (N₂) gas, possibly causing an injury.
- If a gas-filled damper is cut, nitrogen (N₂) gas may cause metal shavings from the cut to scatter. Wear appropriate safety gear such as safety glasses when cutting a gas-filled damper.

Front and Rear Suspension Dampers

- Suspension dampers are installed in the front and the rear suspension.

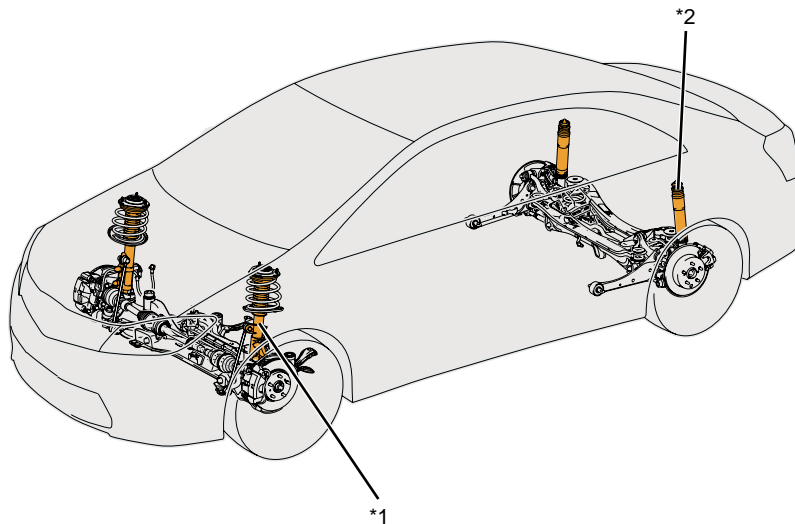

*1 Front Suspension Damper

*2 Rear Suspension Damper

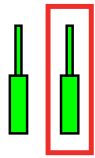

Engine Bonnet Damper

- Gas struts are installed as the stays for the engine bonnet.

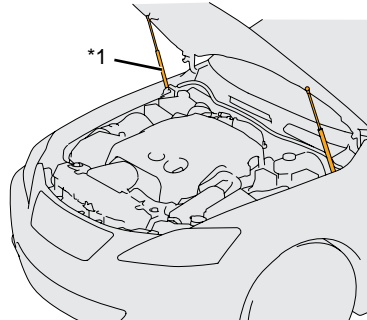

*1	Engine Bonnet Damper
----	----------------------

Luggage Compartment, Hatchback Door, Back Door Dampers

- Gas struts are installed as the stays for the luggage compartment, the hatchback door and the back door.

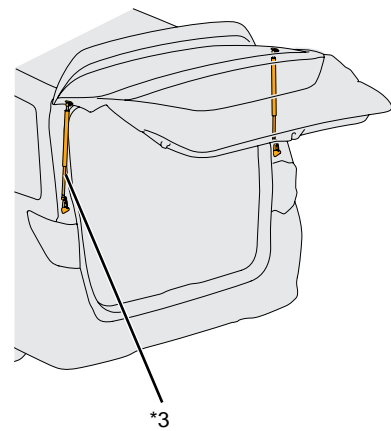
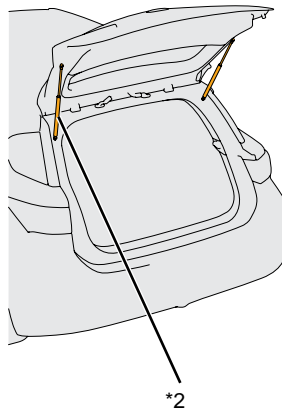
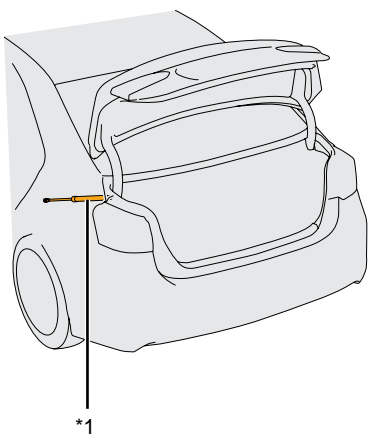

*1	Luggage Compartment Damper
----	----------------------------

*2	Hatchback Door Damper
----	-----------------------

*3	Back Door Damper
----	------------------

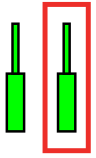

Performance Damper

- Performance dampers are installed across the front and the rear suspension towers and between the right and left sides of the rear lower structural frame (near the rear bumper).

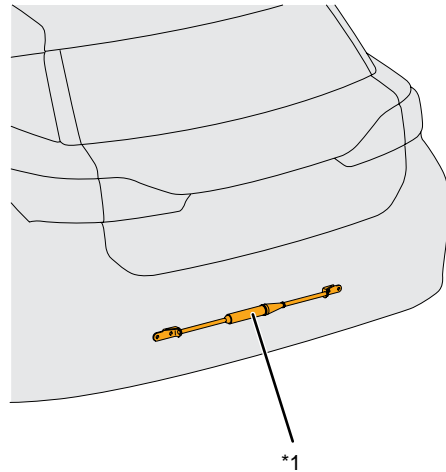
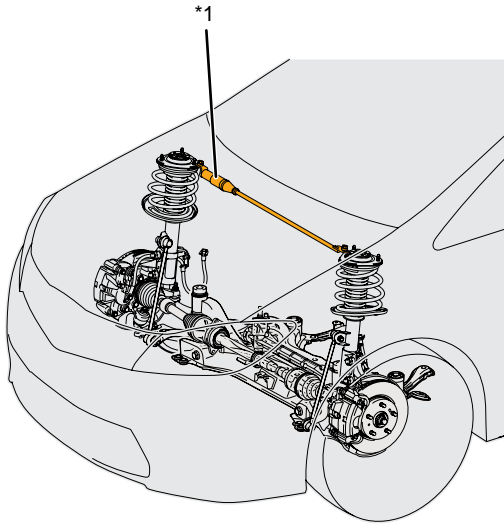

*1	Performance Damper
----	--------------------

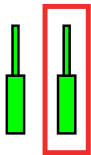

Tail Gate Damper, Side Gate Damper

■ Gas struts are installed as the stays for the tail gate and side gate.

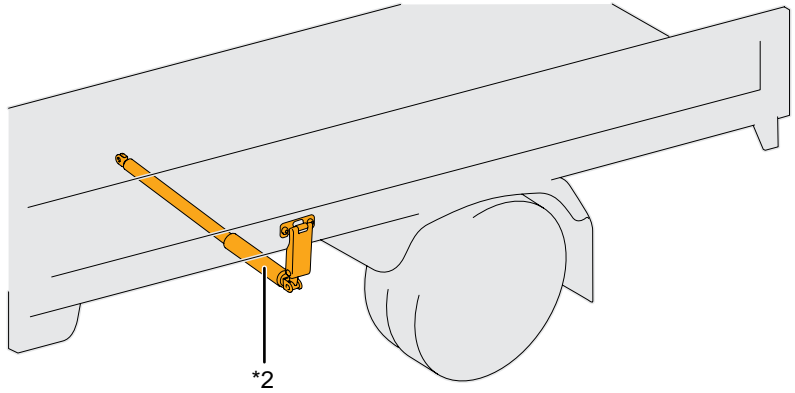
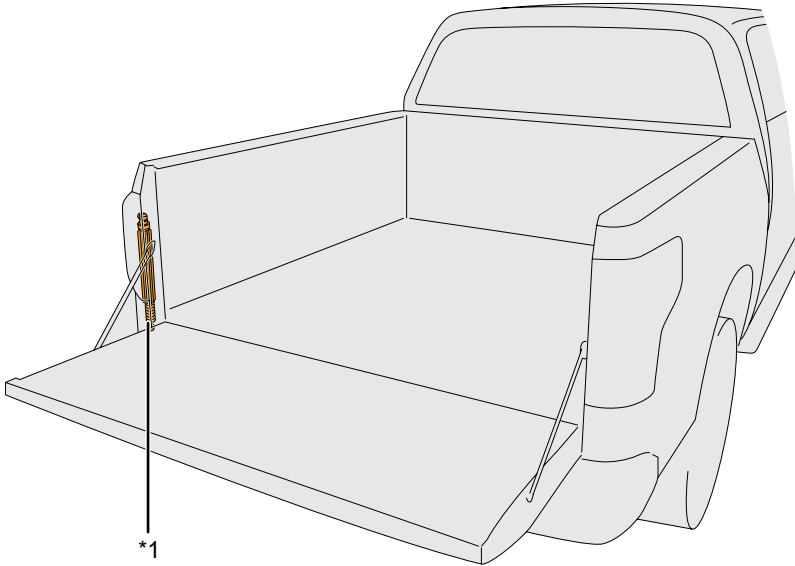

*1	Tail Gate Damper	*2	Side Gate Damper
----	------------------	----	------------------

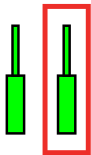





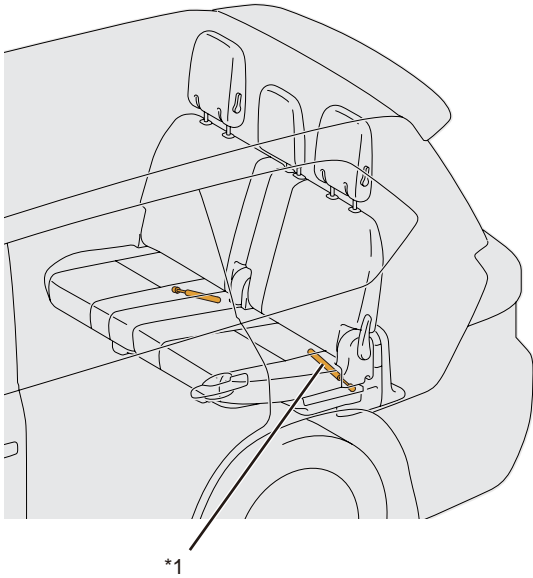













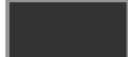
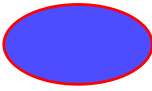



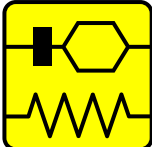
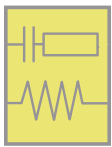

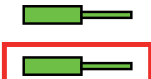
Seat Damper



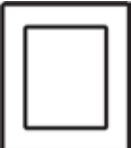
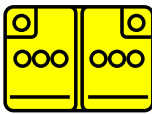

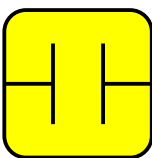





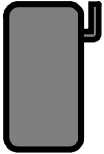





- Seat dampers are equipped to the lower surface of the seat.





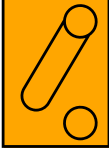
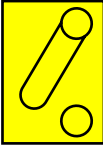

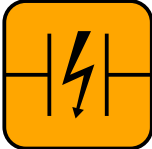

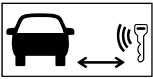





*1	Seat Damper
----	-------------

10. Explanation of pictograms used

	Petrol powered vehicle (Fuel group 2)		Hybrid Electric / Petrol powered vehicle (Fuel group 2)		Electric powered vehicle
	Hydrogen Fuel Cell Electric powered vehicle		Diesel powered vehicle (Fuel group 1)		CNG powered vehicle
	LPG powered vehicle		IG/Power switch		Fuse box
	Airbag		Seat belt pretensioner		Stored gas inflator
	Airbag (incl. Inflator)				Inflator
	SRS control unit		Airbag computer		Pedestrian protection active system
	Automatic rollover protection system		Gas strut / Preloaded spring		High strength zone
			Gas filled damper		Structural reinforcement
	Carbon structure		Zone requiring special attention		Battery low voltage
					12V battery
	Ultra-capacitor, low-voltage		Solar Panel		Fuel tank (petrol)
					
					

 <p>Fuel tank (diesel)</p>	 <p>Gas tank</p>	 <p>Safety valve</p>
 <p>Air tank</p>	 <p>Gas tank with gas type indication (H2)</p>	 <p>Manual gas shut-off valve with gas type indication (H2)</p>
 <p>Automatic hydrogen overpressure safety valve with gas type indication</p>	 <p>Direction of overpressure valve</p>	 <p>Hydrogen tank</p>
 <p>Hydrogen components</p>	 <p>Pressure relief device (PRD) (Hydrogen release direction)</p>	 <p>Battery pack, high-voltage</p>
 <p>High voltage battery</p>	 <p>High voltage component</p>	 <p>High voltage component</p>
 <p>High voltage component / power cable</p>	 <p>Gas line (H2)</p>	 <p>Fuel cell component</p>
 <p>High voltage device that disconnects high voltage</p>	 <p>Device to shut down power in vehicle</p>	 <p>Fuse box disabling high voltage</p>
 <p>High voltage ultra-capacitor</p>	 <p>Low voltage device that disconnects high voltage</p>	 <p>Remove smart key</p>

 <p>Bonnet</p>	 <p>Boot</p>	 <p>Cable cut</p>
 <p>General warning sign</p>	 <p>Hazardous to the human health</p>	 <p>Flammable</p>
 <p>Corrosives</p>	 <p>Explosive</p>	 <p>Acute toxicity</p>
 <p>Warning, Electricity</p>	 <p>Use water to extinguish the fire</p>	 <p>Use thermal Infrared camera</p>
 <p>Right hand drive</p>		

Vehicle Rescue Sheets

86 (ZN6)	161
GR86 (ZN8)	163
Aurion (GSV50)	167
BbZ4X (XEAM10, YEAM15)	169
Camry (ASV50)	173
Camry Hybrid (AVV50)	175
Camry (ASV70 & GSV70)	177
Camry Hybrid (AXVH71)	179
Camry Hybrid (AXVH80)	181
Coaster (XZB70 & GBD70)	185
Corolla Sedan (ZRE172)	187
Corolla Hatch (ZRE182)	189
Corolla Hybrid (ZWE186)	191
Corolla Hatch (MZEA12)	193
Corolla Hybrid Hatch (ZWE211)	195
Corolla Sedan (MZEA12)	197
Corolla Hybrid Sedan (ZWE211/ZWE219)	199
Corolla Cross (MXGA10)	201
Corolla Cross Hybrid (MXGH10 & MXGH15)	205
GR Corolla (GZEA14)	209
C-HR (NGX10/NGX50)	213
C-HR Hybrid (ZYG10)	215
C-HR Hybrid (MAXH25, ZYG20)	217
Fortuner (GUN156)	221
Hiace (TRH201/KDH201)	223
Hiace (TRH22#/KDH22#)	225
Hiace (GRH300/GDH300) (up to 06/2025)	227
Hiace (GRH300/GDH300) (from 06/2025)	229
Hiace/Granvia (GRH303/GDH303)	233
Hiace (GRH320/GDH320) (up to 06/2025)	235
Hiace (GRH320/GDH320) (from 06/2025)	237
Hilux Double Cab (TGN121/GGN12#/GUN12#/GUN13#)	241
Hilux Single Cab (TGN121/GGN12#/GUN12#/GUN13#)	243
Hilux Smart Cab (TGN121/GGN12#/GUN12#/GUN13#)	245
Kluger (GSU50/55)	247
Kluger (GSU70/75 & TXUA70/75)	249
Kluger Hybrid (AXUH78) (up to 11/2023)	253
Kluger Hybrid (AXUH78) (from 11/2023)	257

continued overleaf

LandCruiser 70 Wagon (GDJ/VDJ76)	261
LandCruiser 70 Troop Carrier (GDJ/VDJ78)	263
LandCruiser 70 Double Cab Chassis (GDJ/VDJ79)	265
LandCruiser 70 2 Door (GDJ/VDJ79)	267
LandCruiser 200 (URJ202/VDJ200)	269
LandCruiser 300 (FJA300)	271
LandCruiser Prado 150 (GRJ150/GDJ150)	275
LandCruiser Prado 250 (GDJ251)	277
Mirai (JPD10)	281
Mirai (JPD20) (up to 12/2023)	283
Mirai (JPD20) (from 12/2023)	287
Prius (ZVW50)	291
Prius C (NHP10)	293
Prius V (ZVW40)	295
RAV4 (ZSA42/ASA44/ALA49)	297
RAV4 (MXAA52/AXAA54)	299
RAV4 Hybrid (AXAH52/AXAH54)	301
Supra (DB42)	303
Tarago (ACR50/GSR50)	305
Tundra (VXKH75) (up to 08/2025)	307
Tundra (VXKH75) (from 08/2025)	311
Yaris 3 Door (NCP130)	315
Yaris 5 Door (NCP130)	317
Yaris 3 Door (NCP130) (with rear seat belt pretensioners)	319
Yaris 5 Door (NCP130) (with rear seat belt pretensioners)	321
Yaris (MXPA10)	323
Yaris Cross (MXPB10)	327
Yaris Cross Hybrid (MXPJ10 & MXPJ15) (up to 01/2024)	331
Yaris Cross Hybrid (MXPJ10 & MXPJ15) (from 01/2024)	335
Yaris Hybrid (MXPJ10) (up to 04/2024)	339
Yaris Hybrid (MXPJ10) (from 04/2024)	343
GR Yaris (GXPA16)	347

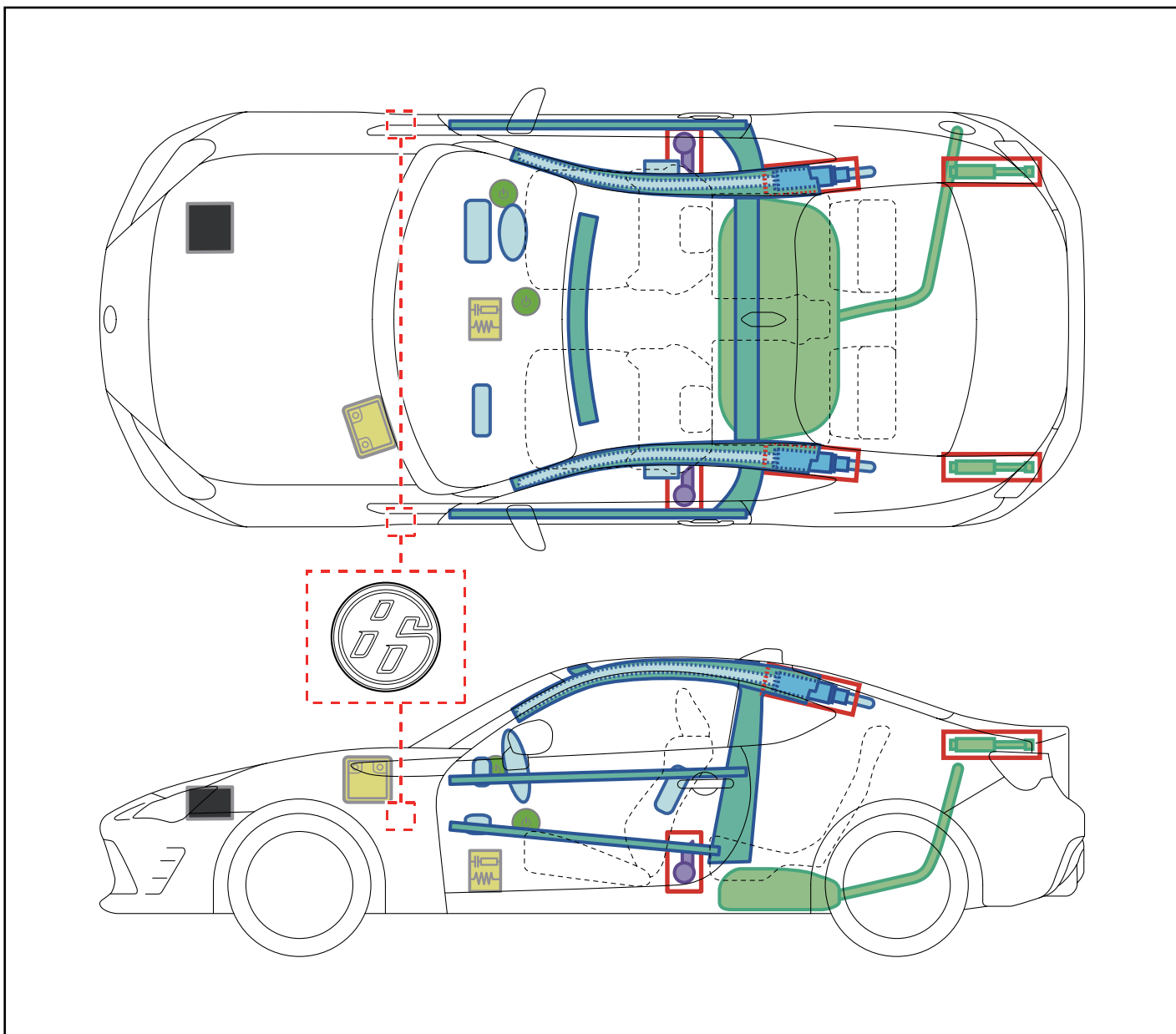
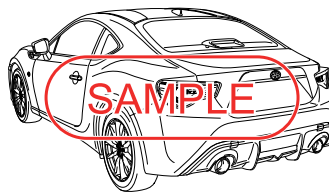
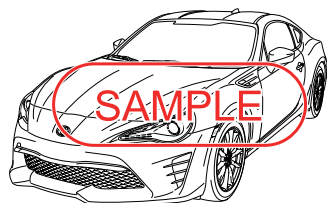

	IG/POWER SW		Fuse Box		12V Battery
	Airbag (incl. Inflator)		Inflator		Fuel Tank
	Gas-filled Damper		Seat Belt Pretensioner (Gas Generator)		Structural Reinforcements
	Airbag Computer	-	-	-	-
-	-	-	-	-	-

Disable Vehicle

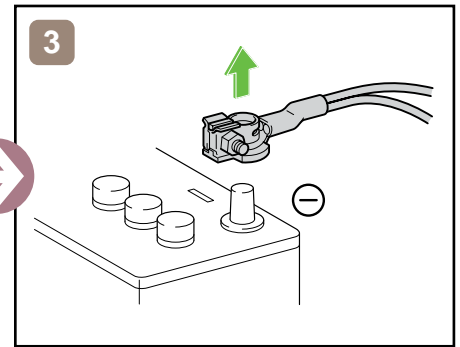
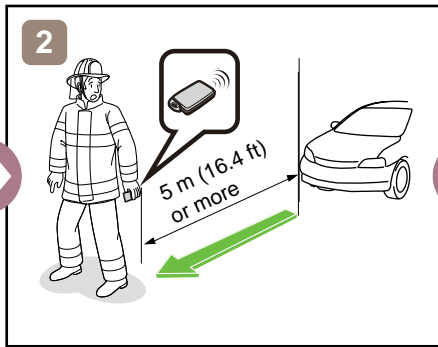
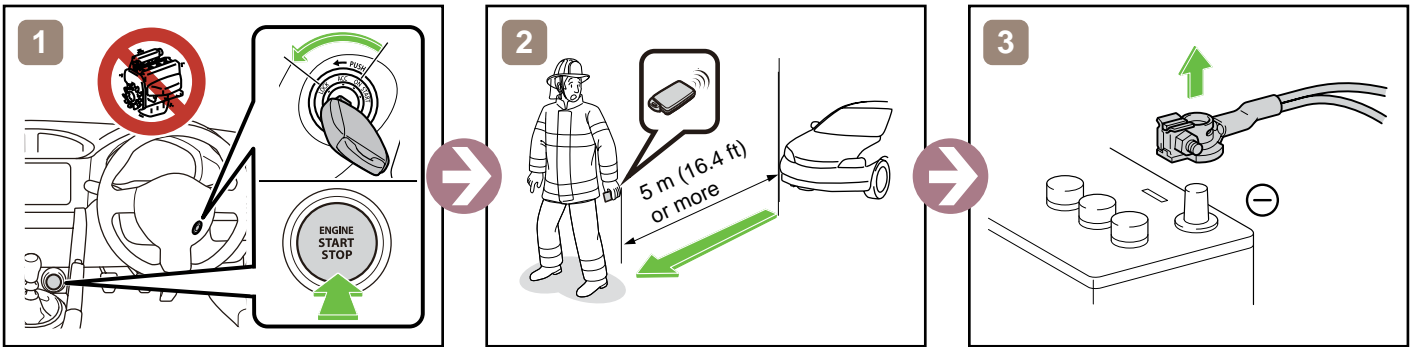

or

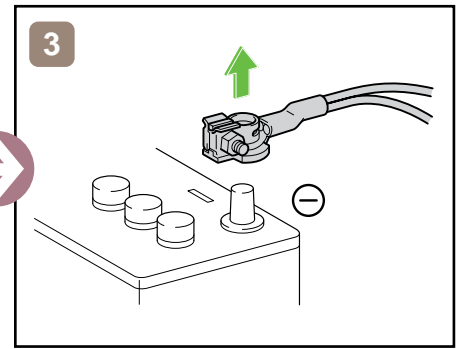
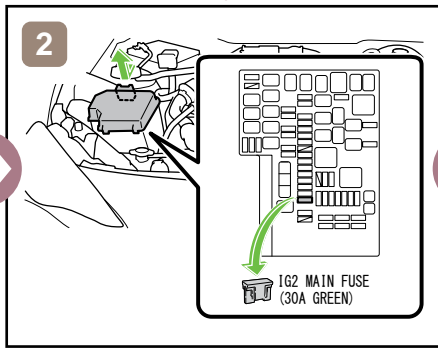
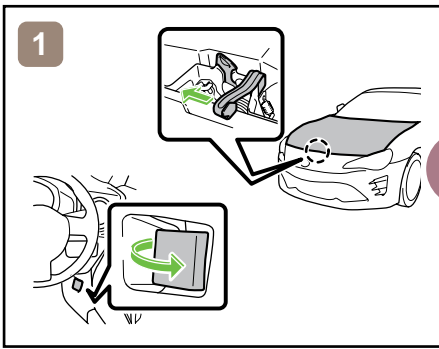

Access to 12V Battery

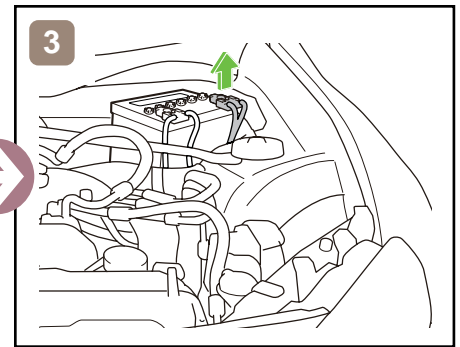
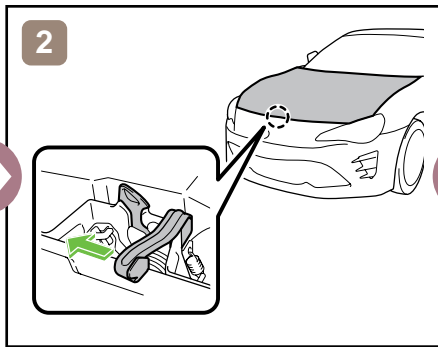
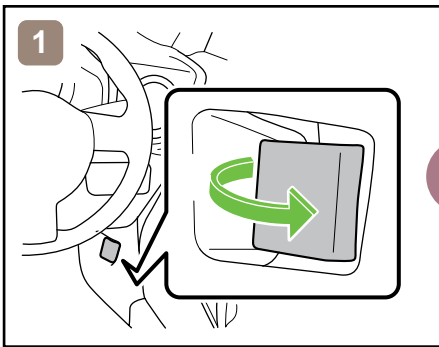

Towing Information

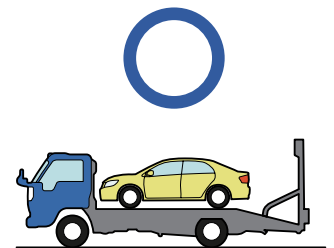
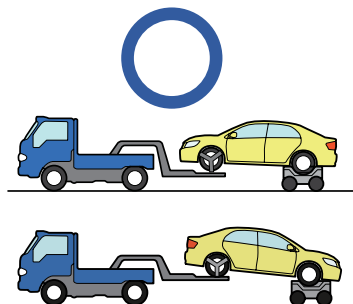
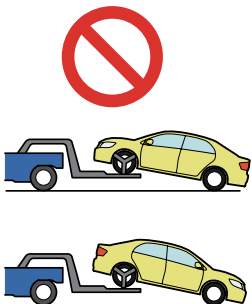

More details, please refer to "Emergency Response Guide".



TOYOTA GR 86

2022-03

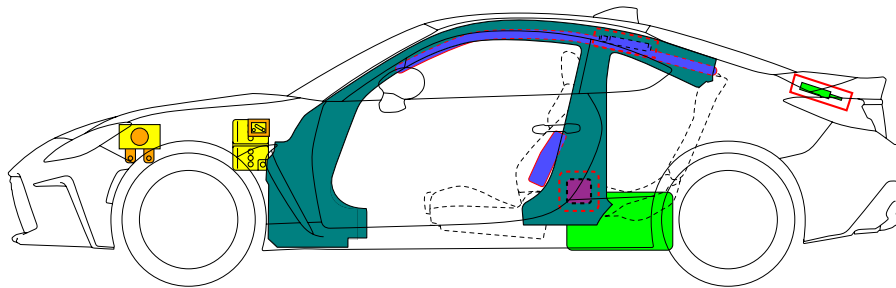
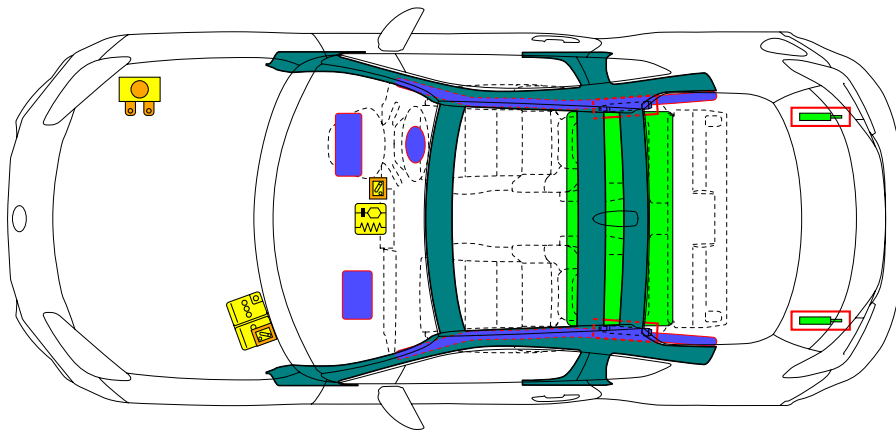

	Airbag		Stored gas inflator		Seat belt pretensioner		SRS control unit		Pedestrian protection active system
	Automatic rollover protection system		Gas strut / Preloaded spring		High strength zone		Zone requiring special attention		
	Battery low voltage		Ultra capacitor, low voltage		Fuel tank		Gas tank		Safety valve
	High voltage battery pack		High voltage power cable / component		High voltage disconnect		Fuse box disabling high voltage system		Ultra capacitor, high voltage
	Low voltage device that disconnects high voltage								
	ID No.	Version No.		Version date		Page			
	GR868	01		03 / 2022		1 / 4			

1. Identification / Recognition

Location of vehicle badges

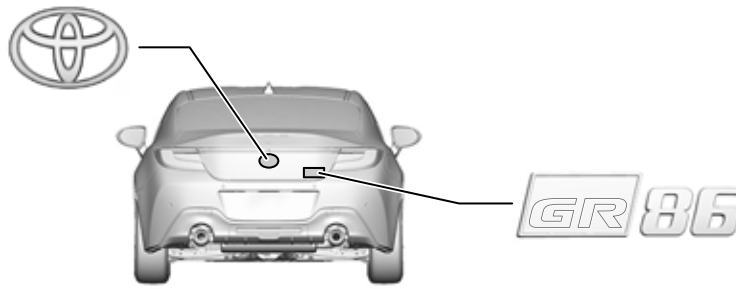

2. Immobilisation / Stabilisation / Lifting

Completely immobilize the vehicle

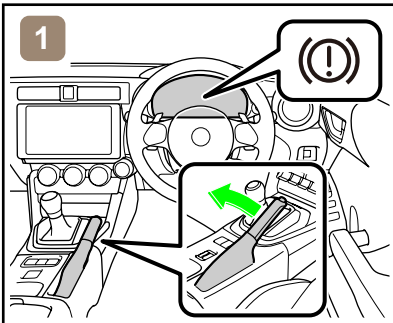

1. Chock the wheels and engage the parking brake.

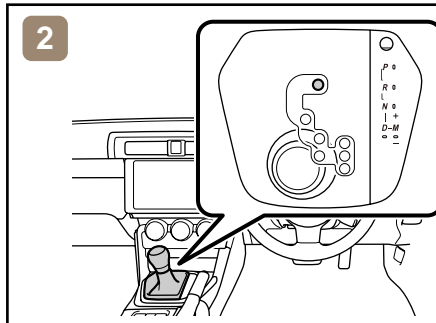

2. Move the shift lever to the park (P) position.

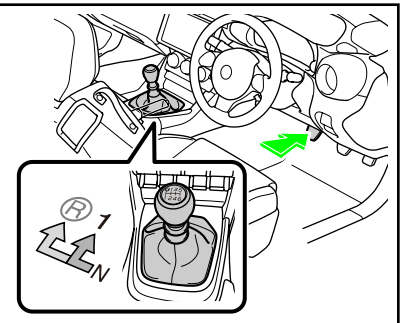

2. Depress the clutch pedal and move the shift lever to the 1st or reverse (R) position.

Stabilisation-lifting point

Place cribbing such as wooden blocks at the four points under the front and rear pillars.

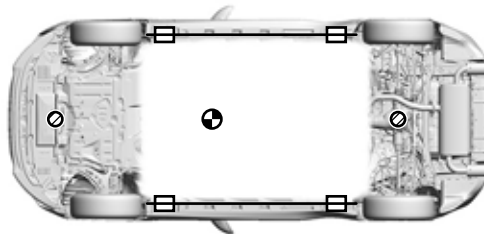

Extra Reinforced Lifting Points



Standard Jack Locations



Vehicle Center of Gravity



Do not place cribbing such as wooden blocks or rescue air lifting bags under the exhaust system or fuel system. Doing so may result in fuel leaks or fire.

3. Disable direct hazards / Safety regulations

If any of the following systems are required to be operated, operate them BEFORE disconnecting the battery.

Power door lock

Power window

Trunk opener



When the 12 V battery is disconnected, electrical components cannot be operated.

ID No.	Version No.	Version date	Page
GR868	01	03 / 2022	2 / 4

■ Perform procedure Main or Alternative to completely shut off the vehicle.

<Procedure Main>

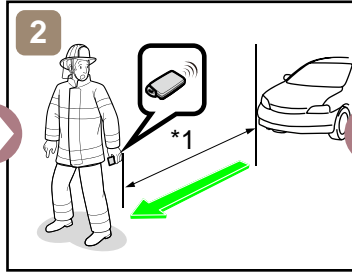
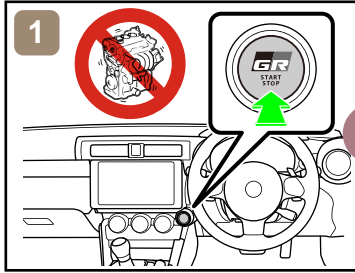
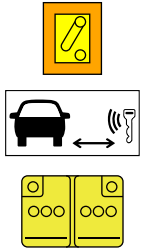

*1: 5 m (16.4 ft) or more

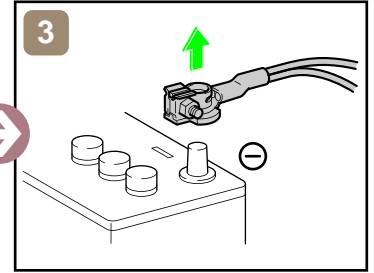

<Procedure Alternative>

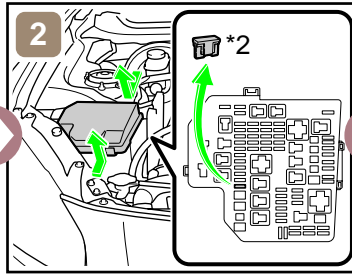
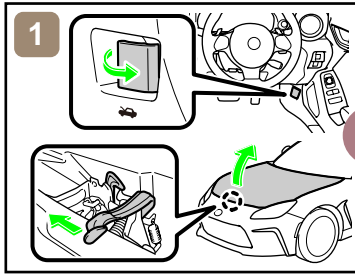
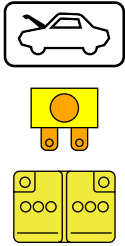

*2: IG2-MAIN (20 A YELLOW)

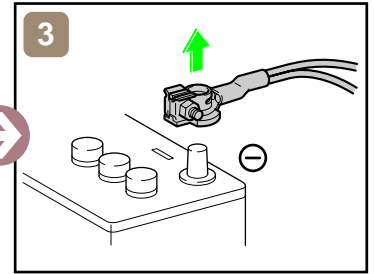

■ Access to 12 V Battery

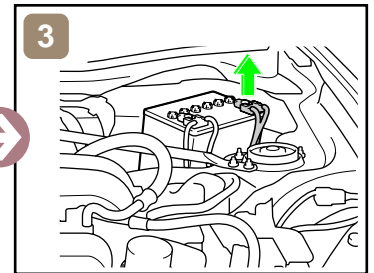
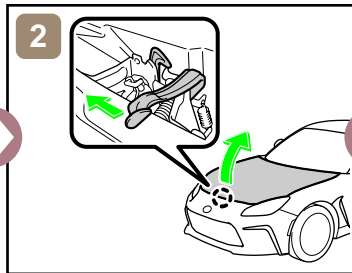
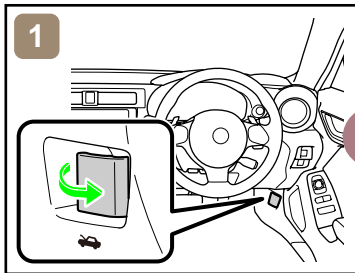
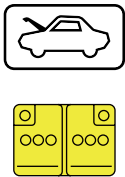

4. Access to the occupants

■ Window Glass

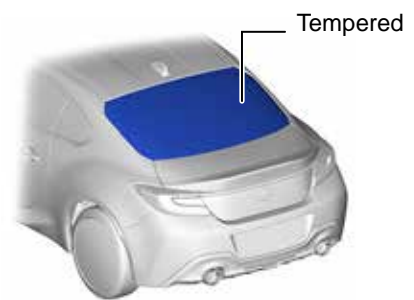
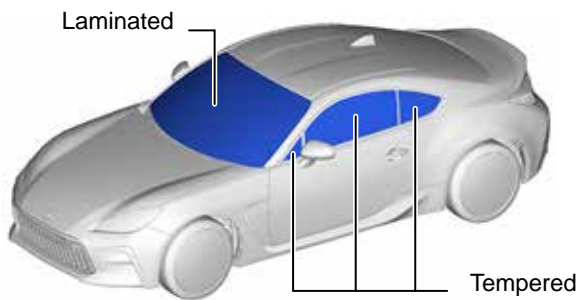

ID No.	Version No.	Version date	Page
GR868	01	03 / 2022	3 / 4

5. Stored energy / Liquids / Gases / Solids



12 V Battery



Gasoline Tank: 50 L



Always wear appropriate personal protective equipment (PPE) when dealing with any of these items.

6. In case of fire

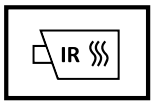

RE-IGNITION POSSIBLE !

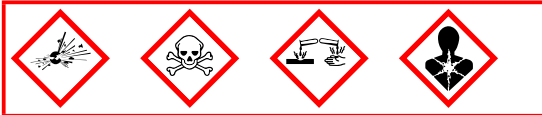

7. In case of submersion



Work on the vehicle only after the vehicle has been pulled out of the water.

8. Towing / Transportation / Storage

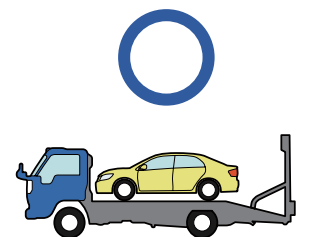
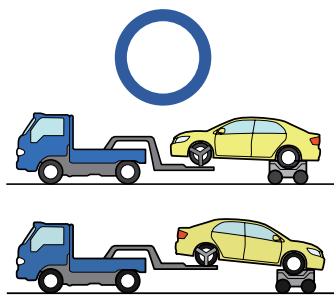
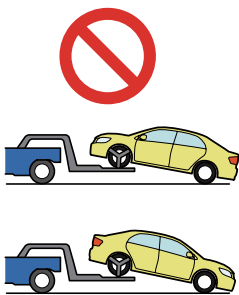

RE-IGNITION POSSIBLE !

Store the vehicle at a safe distance (15 m (49.2 ft) or more) from other vehicles.

9. Important additional information

For further details, please refer to "Emergency Response Guide".

	ID No.	Version No.	Version date	Page
	GR868	01	03 / 2022	4 / 4

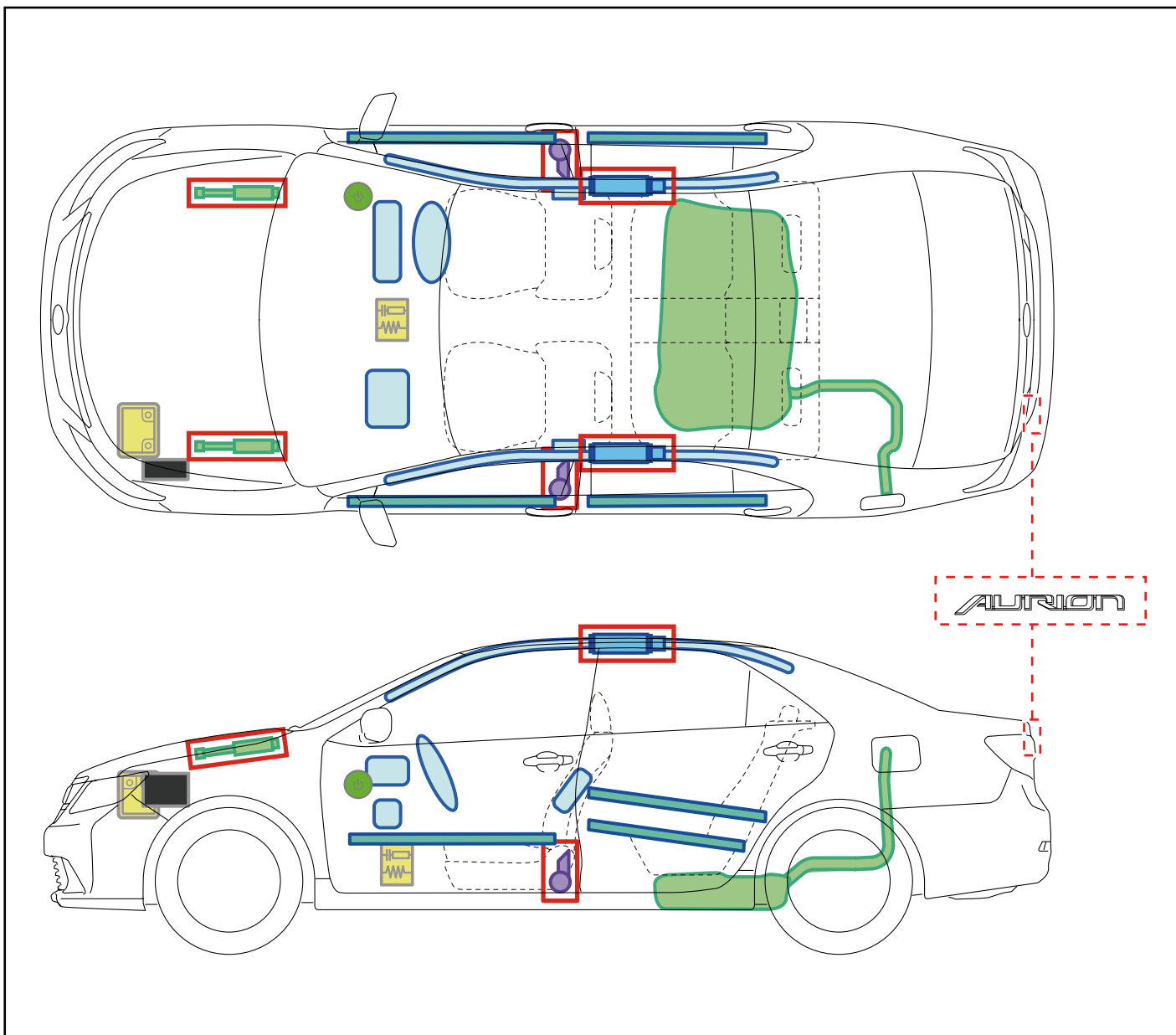
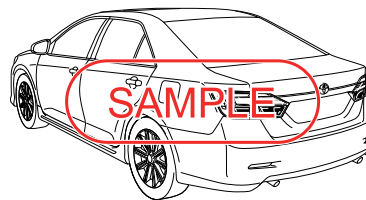
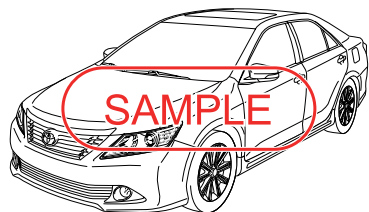

	ENGINE SW		Fuse Box		12V Battery
	Airbag (incl. Inflator)		Inflator		Fuel Tank
	Gas-filled Damper		Seat Belt Pretensioner (Gas Generator)		Structural Reinforcements
	Airbag Computer	-	-	-	-
-	-	-	-	-	-

Disable Vehicle

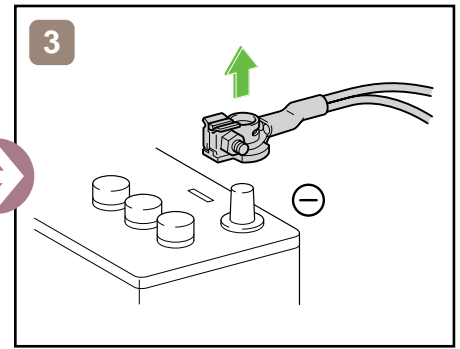
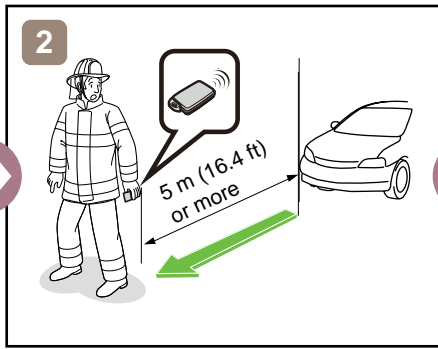
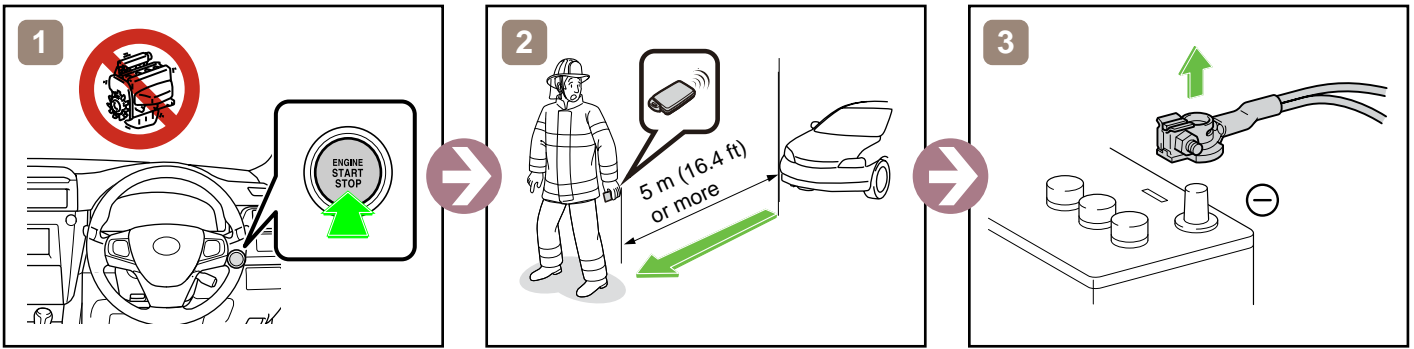

or

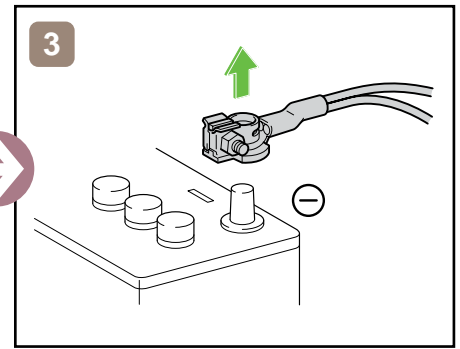
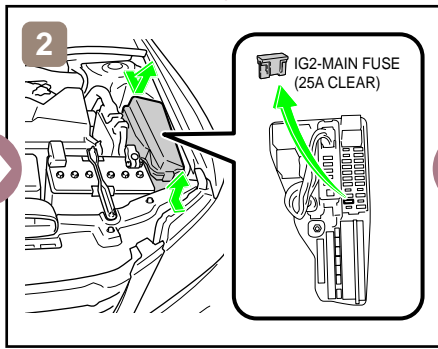
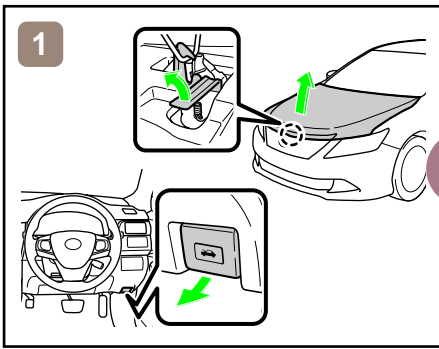

Access to 12V Battery

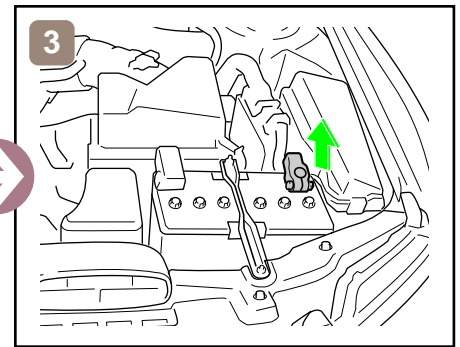
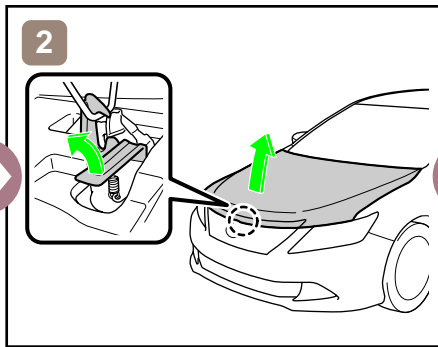
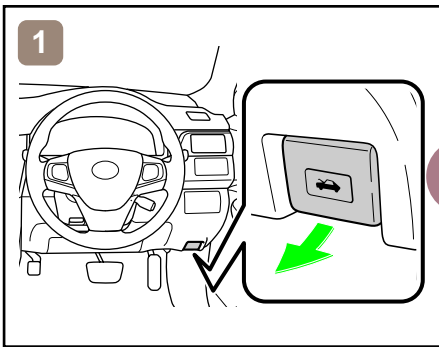

Towing Information

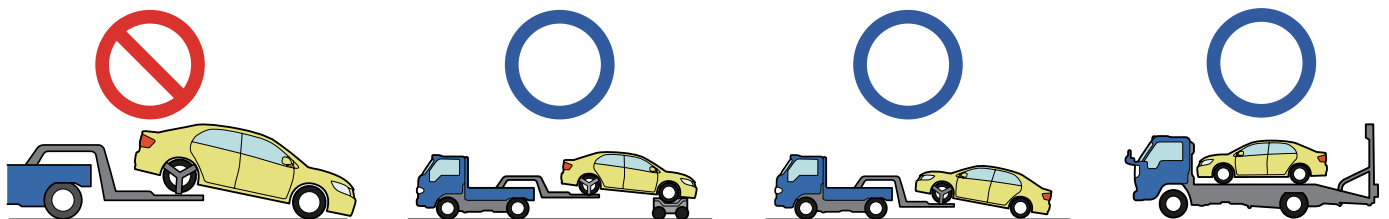

More details, please refer to "Emergency Response Guide".

1. Identification / Recognition

■ Location of vehicle badges

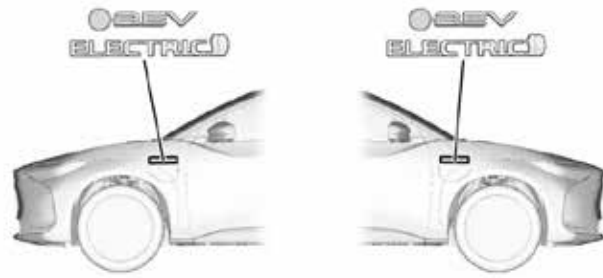
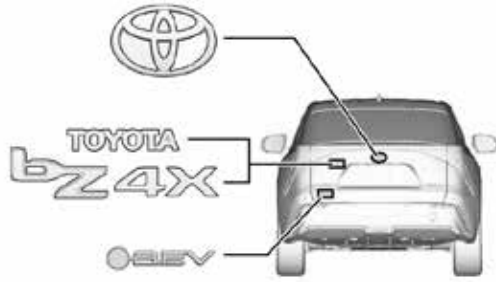

■ Energy source: Lithium-ion battery



2. Immobilisation / Stabilisation / Lifting

■ Completely immobilize the vehicle

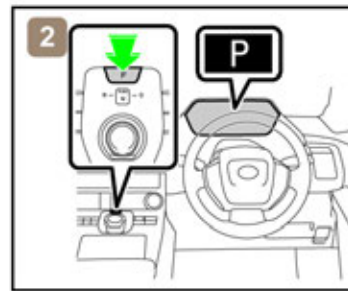
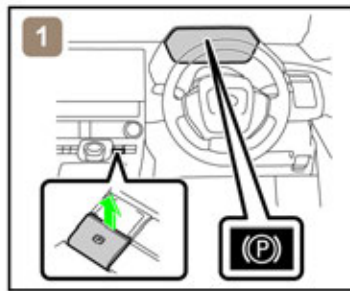

- 1) Chock the wheels and engage the parking brake. 2) Press the P position switch.

■ Stabilisation-lifting point

Place cribbing such as wooden blocks at the four points under the front and rear pillars.



Extra Reinforced Lifting Points



Standard Jack Locations



Vehicle Center of Gravity



Do not place cribbing such as wooden blocks or rescue air lifting bags under the exhaust system, fuel system or high voltage power cables. Doing so may result in fuel leaks, fire, or electric shock.

3. Disable direct hazards / Safety regulations

■ If any of the following systems are required to be operated, operate them **BEFORE** disconnecting the battery.

Power door lock
Power Back door

Power window
Electric parking brake

Power seat
Electronic shift matic

When the 12 V battery is disconnected, electrical components cannot be operated.

■ Perform procedure Main or Alternative to completely shut off the vehicle.

< Main Procedure >

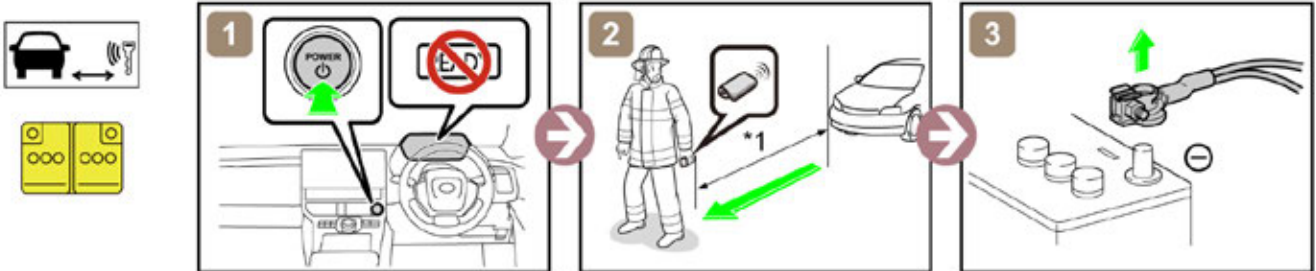

*1: 5 m (16.4 ft) or more

< Alternative Procedure >

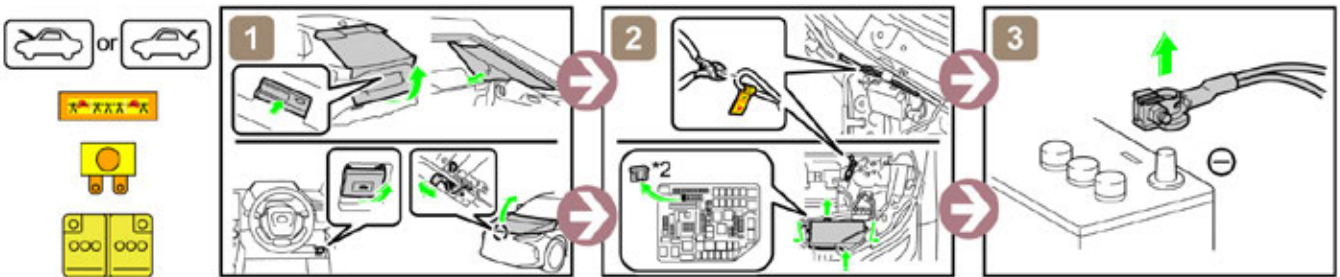

*2: IGP-MAIN NO.1 (30 A GREEN)

In the event of an accident in which the airbags are deployed, the high-voltage system will be automatically deactivated.

■ Access to 12 V Battery

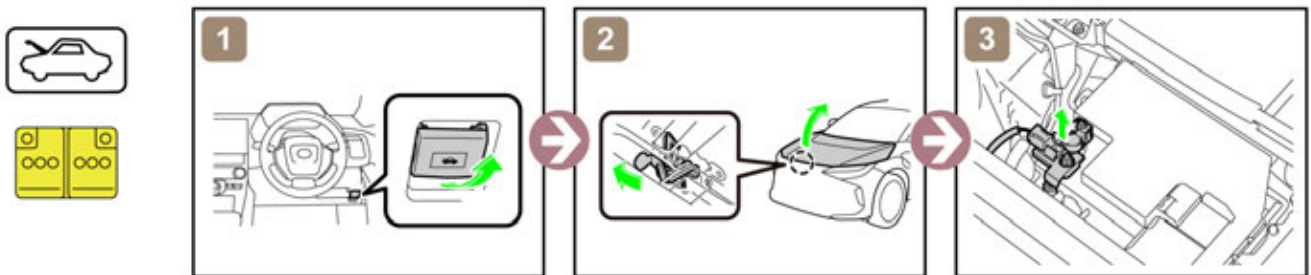

4. Access to the occupants

■ Window Glass

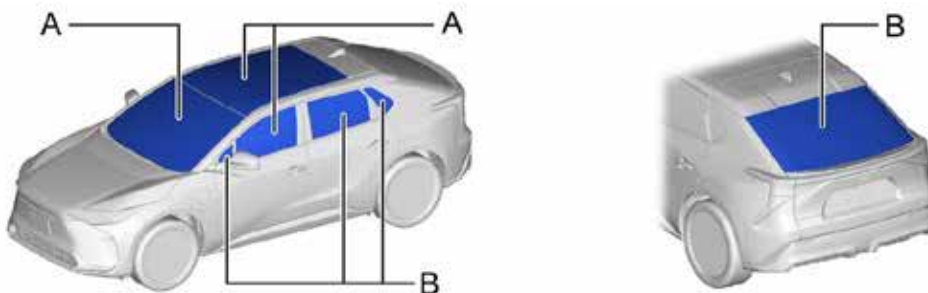

A	Laminated	B	Tempered
---	-----------	---	----------

5. Stored energy / Liquids / Gases / Solids



High Voltage Li-ion Battery



12 V Battery



- Always wear appropriate personal protective equipment (PPE) when dealing with any of these items.
- Never breach or remove the battery assembly cover under any circumstances, including fire. Doing so may result in serious injury or death from severe burns or electric shock.

6. In case of fire



USE COPIOUS AMOUNTS OF WATER

If it is difficult to apply copious amounts of water to the high voltage battery, it is recommended to allow the high voltage battery to burn itself out.



RE-IGNITION POSSIBLE !



7. In case of submersion



Do not touch any of the high-voltage components or cables, including the service plug, while the vehicle is submerged. Doing so may result in electric shock.
Work on the vehicle only after the vehicle has been pulled out of the water.

8. Towing / Transportation / Storage

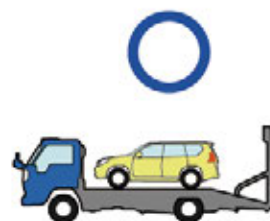

RE-IGNITION POSSIBLE !

Store the vehicle at a safe distance (15 m (49.2 ft) or more) from other vehicles.

9. Important additional information

For further details, please refer to "Emergency Response Guide".

ID No.	Version No.	Version date	Page
bZ4X10	03	07 / 2025	4 / 4

CAMRY

2014-9

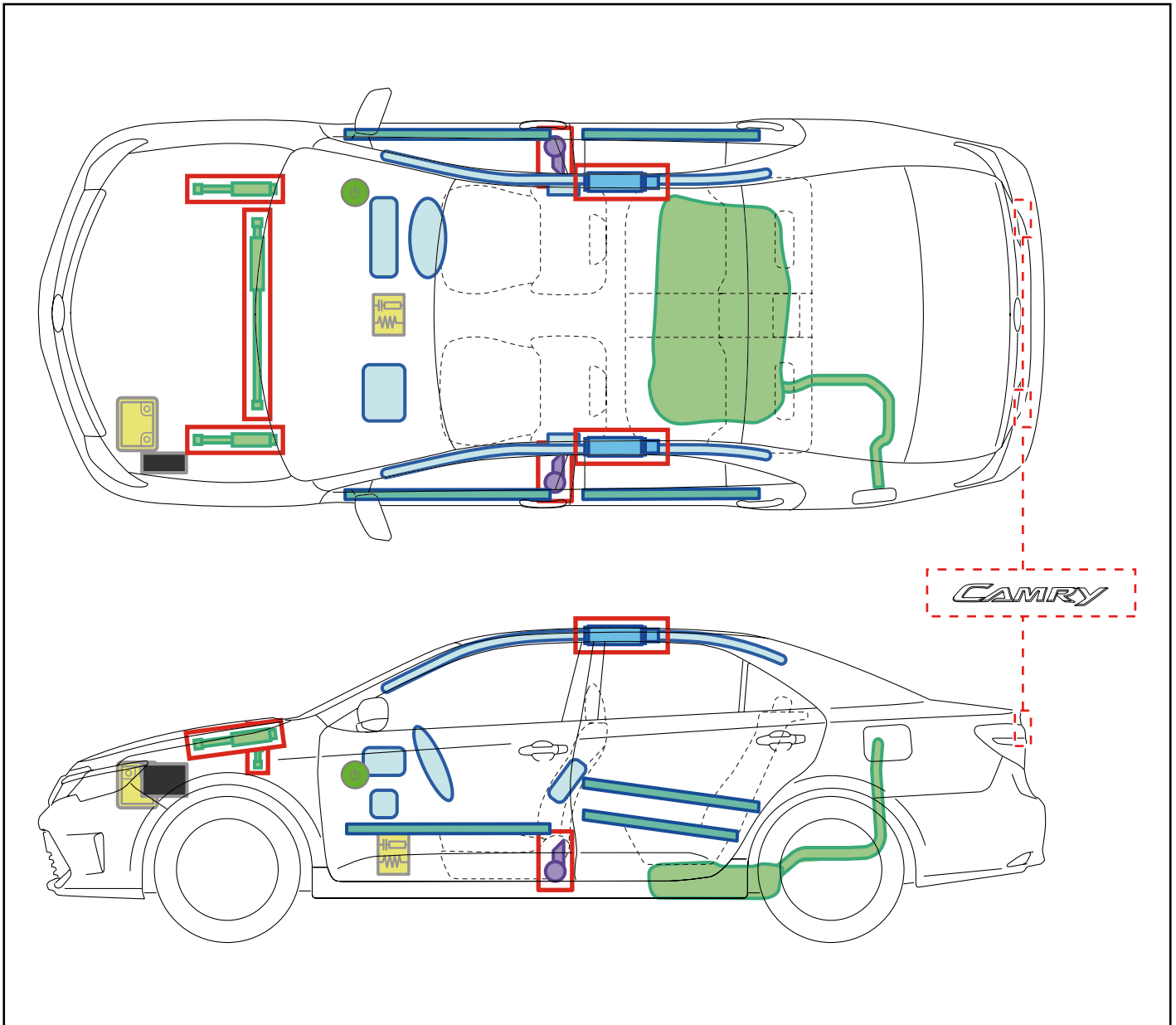

	IG/ENGINE SW		Fuse Box		12V Battery
	Airbag (incl. Inflator)		Inflator		Fuel Tank
	Gas-filled Damper		Seat Belt Pretensioner (Gas Generator)		Structural Reinforcements
	Airbag Computer	-	-	-	-
-	-	-	-	-	-

Disable Vehicle

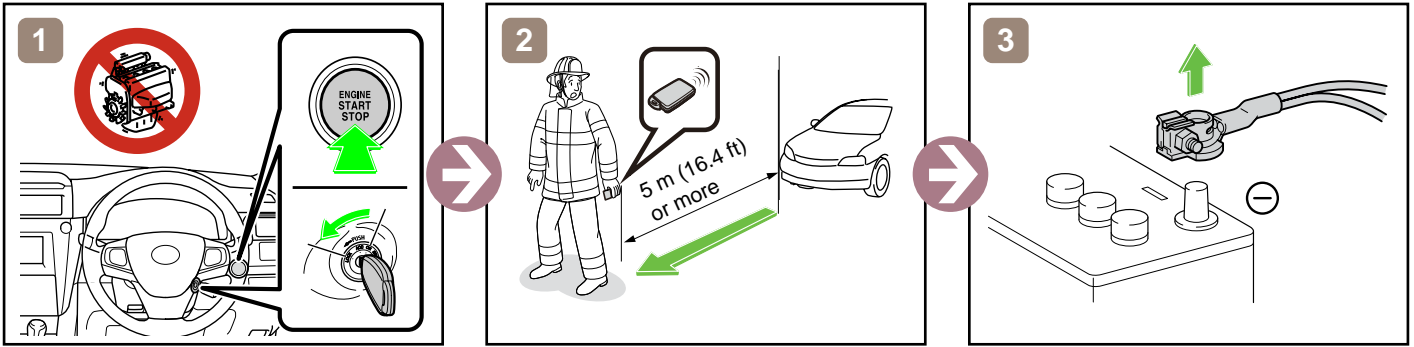

or

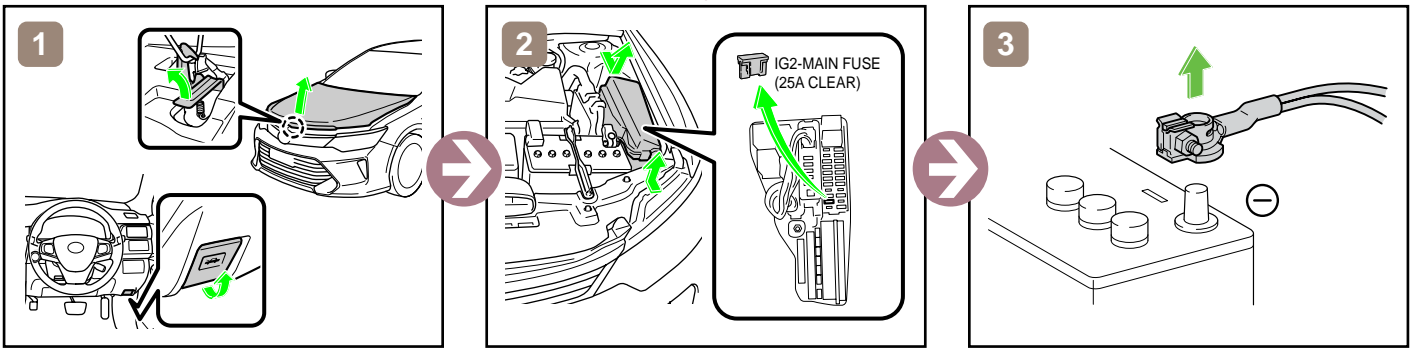

Access to 12V Battery

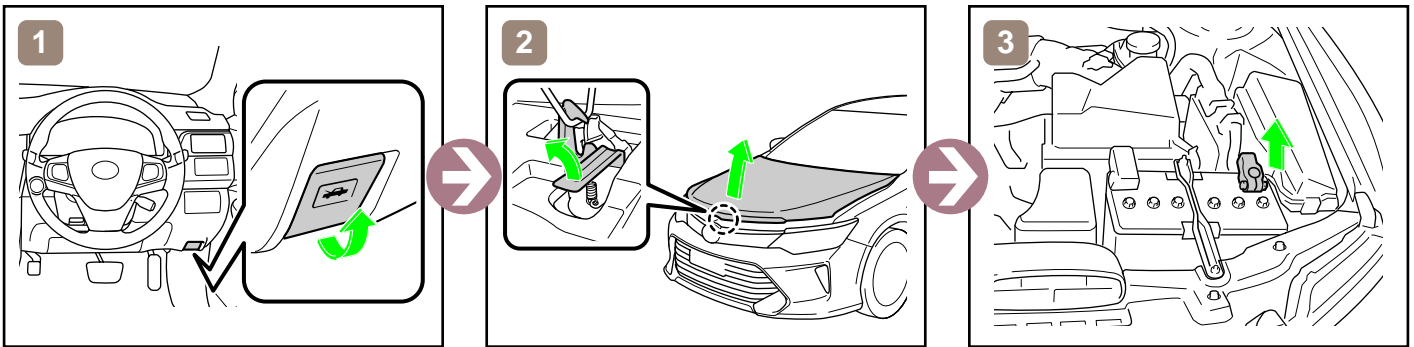

Towing Information

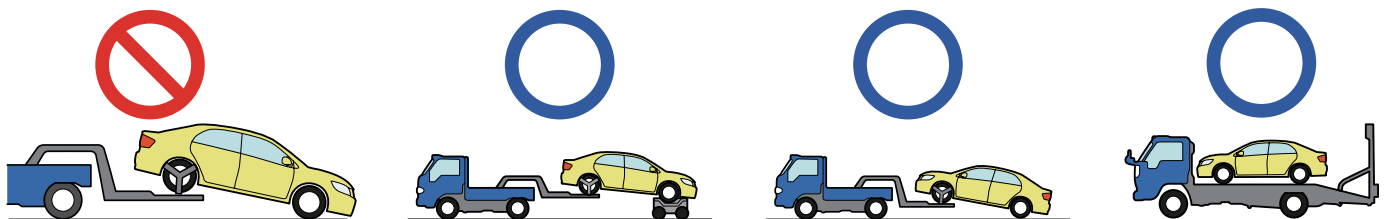







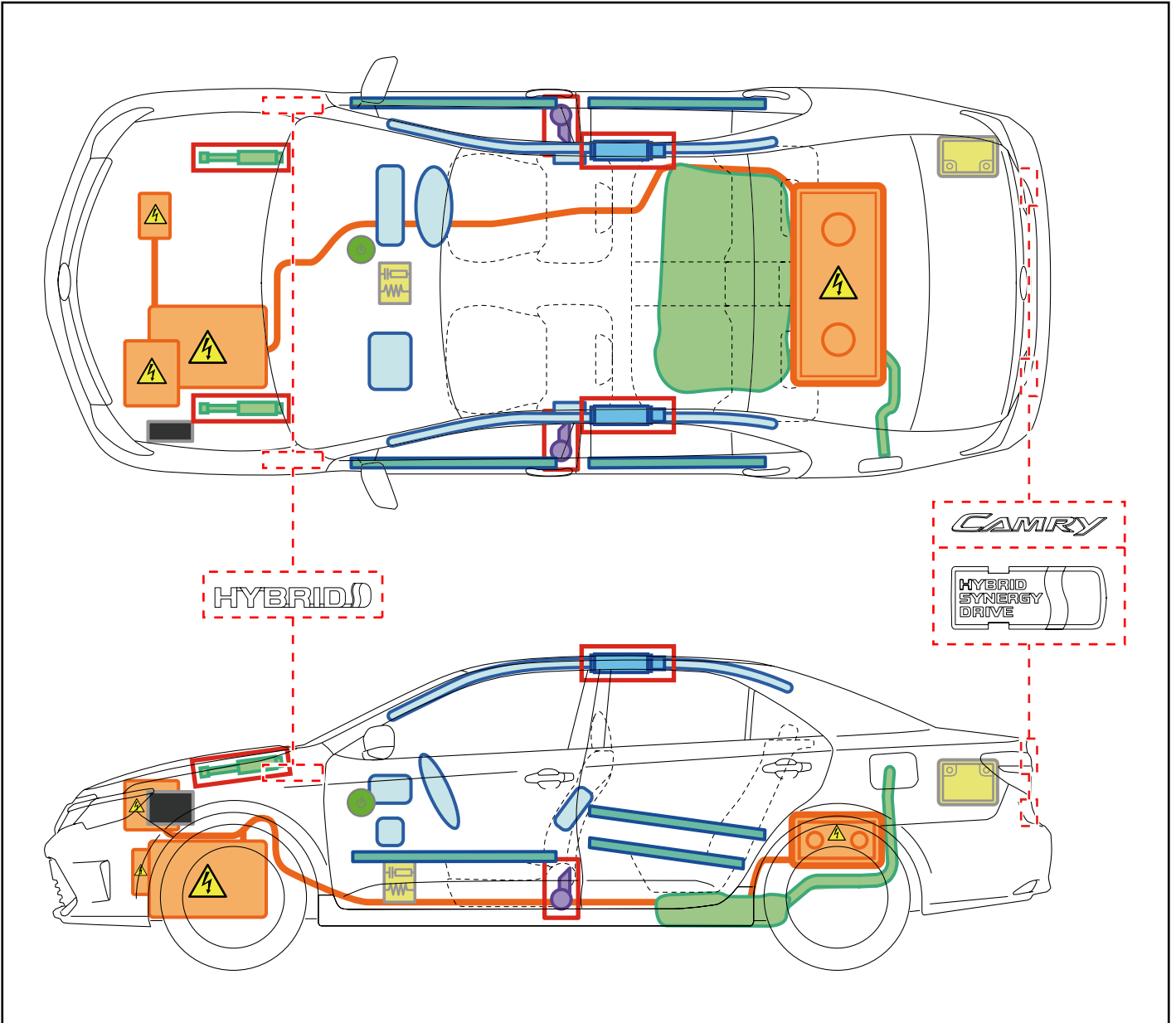





More details, please refer to "Emergency Response Guide".

CAMRY HYBRID

2014-9



	POWER SW		Fuse Box		12V Battery
	Airbag (incl. Inflator)		Inflator		High Voltage Battery
	High Voltage Components		Fuel Tank		Gas-filled Damper
	Seat Belt Pretensioner (Gas Generator)		Structural Reinforcements		Airbag Computer
-	-	-	-	-	-

Disable Vehicle

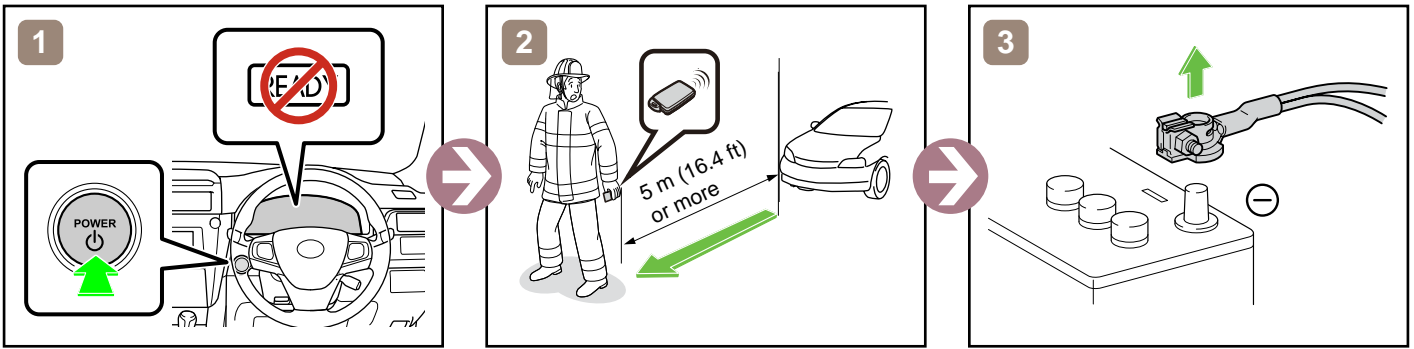

or

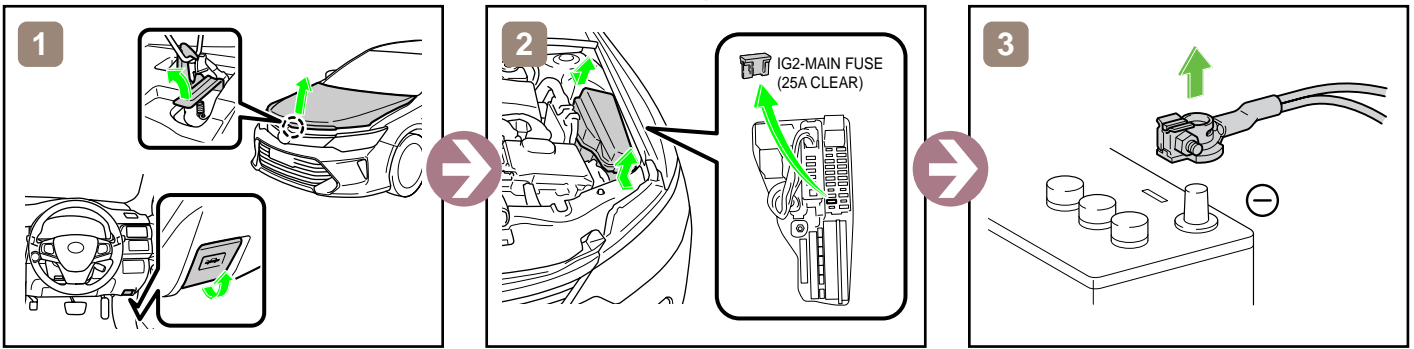

Access to 12V Battery

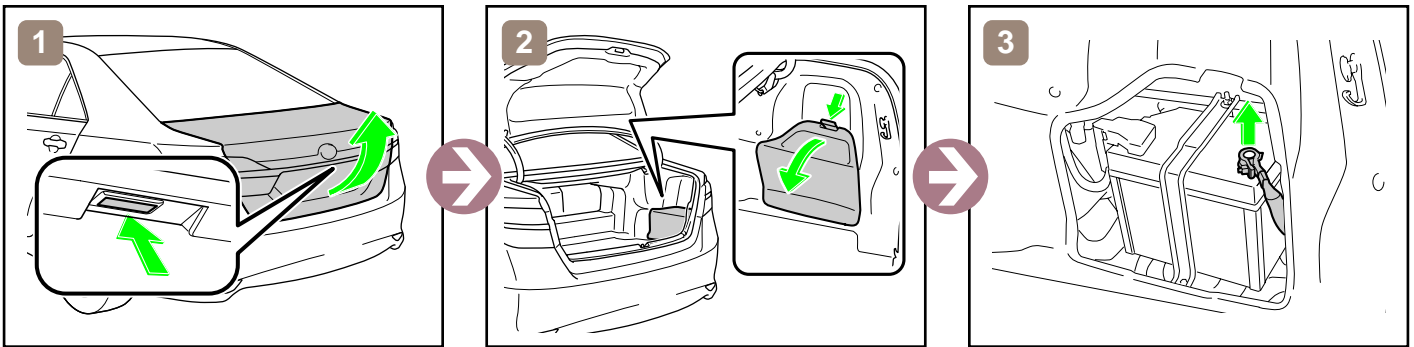

Towing Information

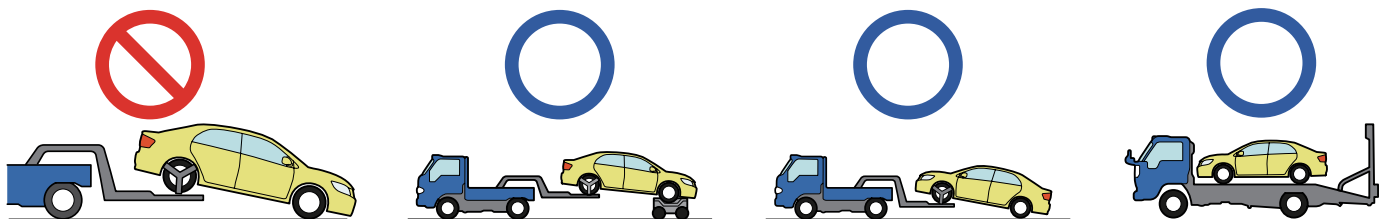

More details, please refer to "Emergency Response Guide".

CAMRY

RHD

2017-6

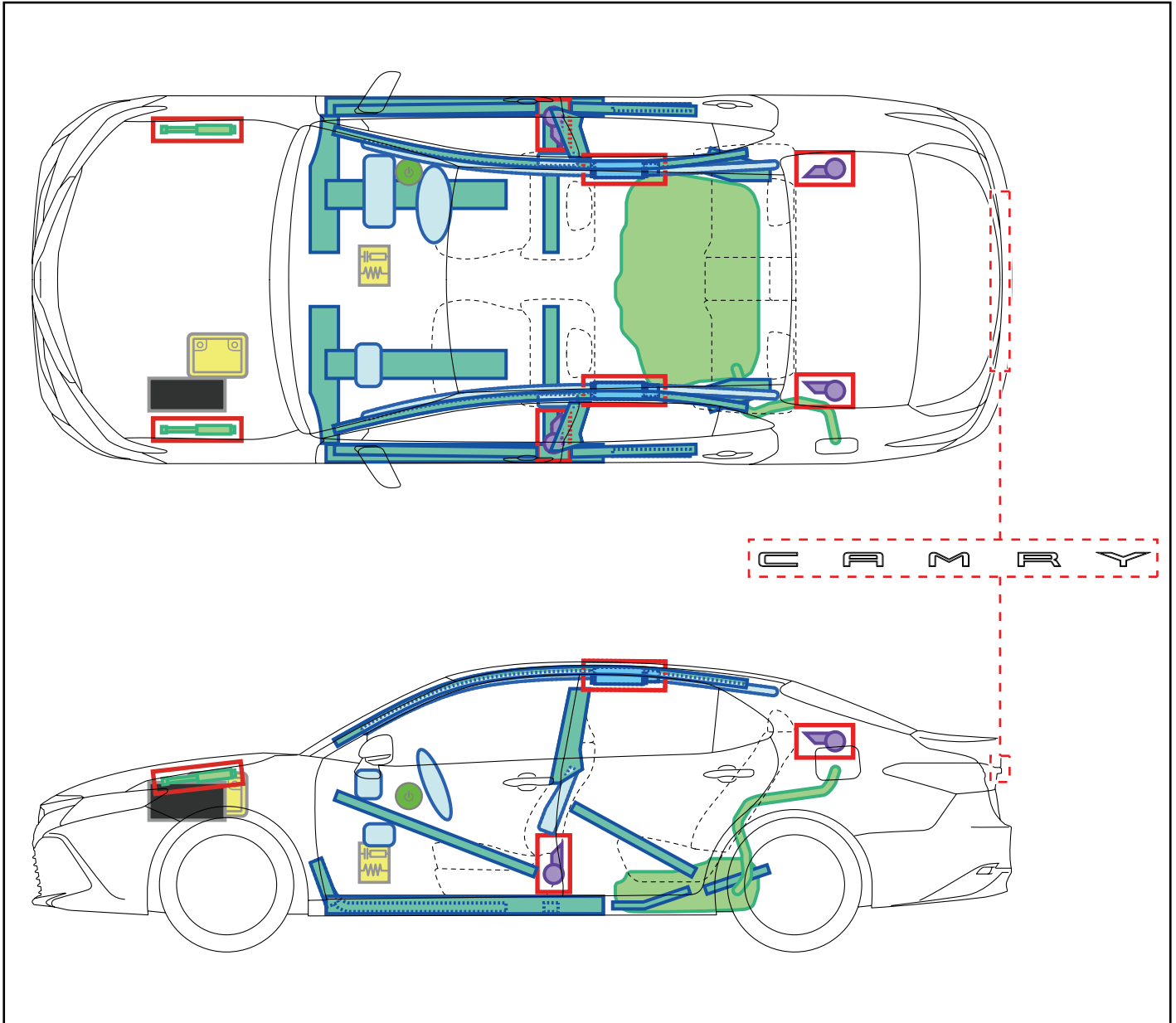
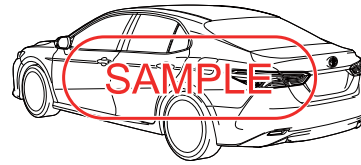
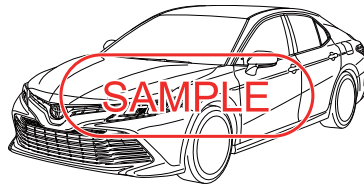

	IG/POWER SW		Fuse Box		12V Battery
	Airbag (incl. Inflator)		Inflator		Fuel Tank
	Gas-filled Damper		Seat Belt Pretensioner (Gas Generator)		Structural Reinforcements
	Airbag Computer	-	-	-	-
-	-	-	-	-	-

Disable Vehicle

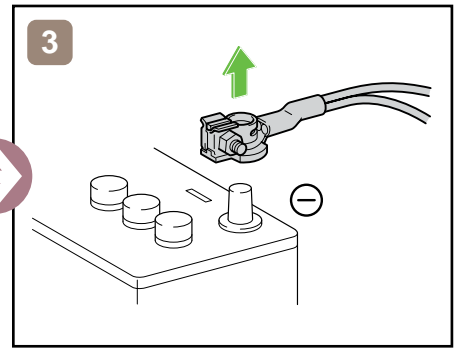
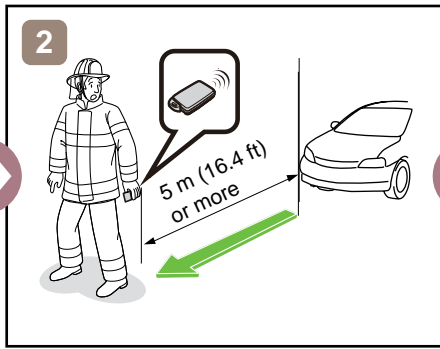
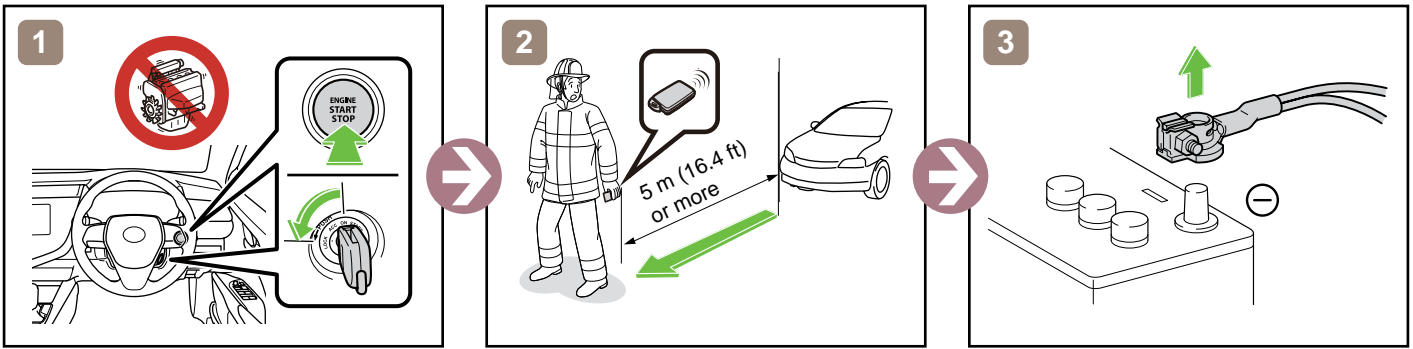

or

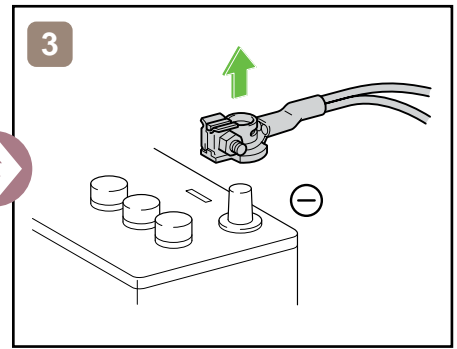
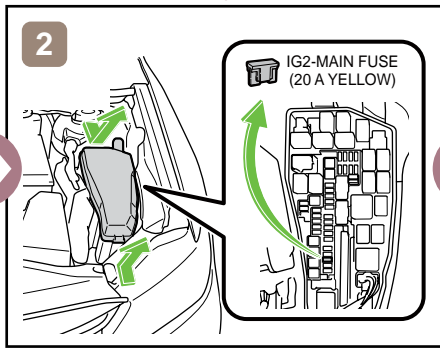
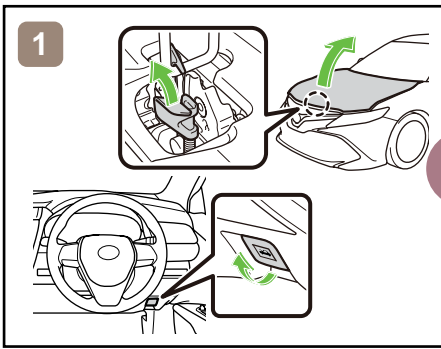

Access to 12V Battery

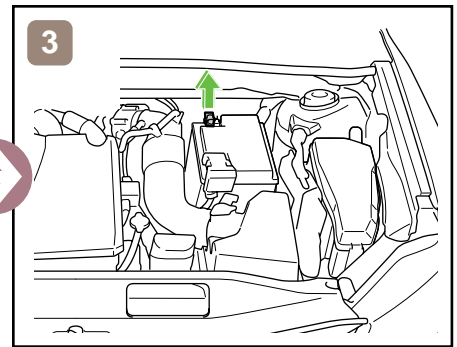
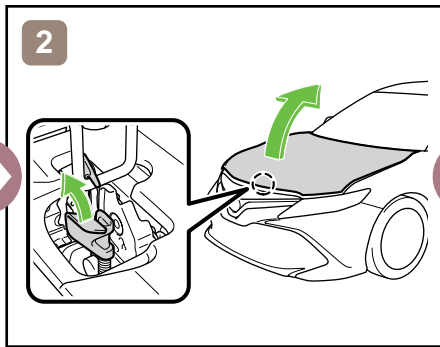
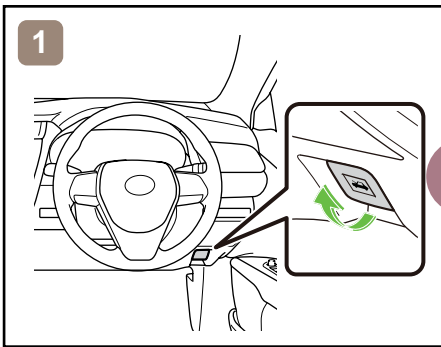

Towing Information

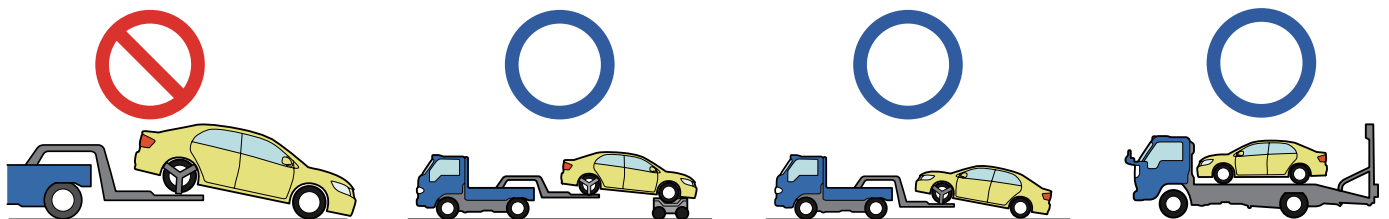

More details, please refer to "Emergency Response Guide".

CAMRY HYBRID

RHD

2017-9



TOYOTA

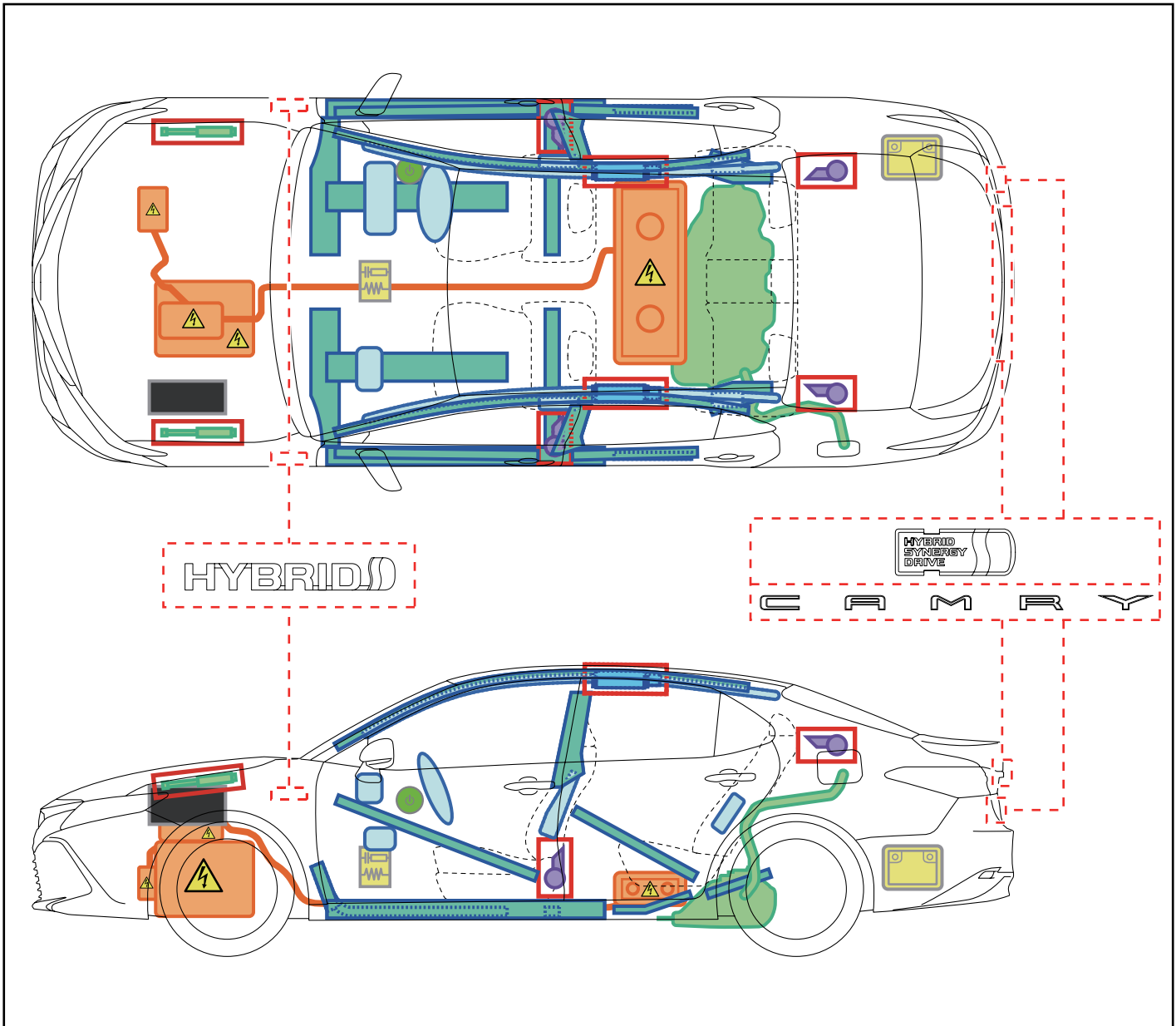
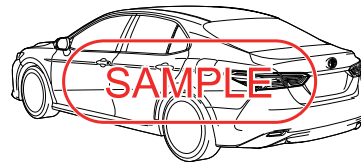
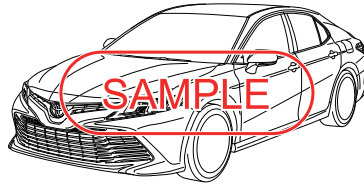

	IG/POWER SW		Fuse Box		12V Battery
	Airbag (incl. Inflator)		Inflator		High Voltage Battery
	High Voltage Components		Fuel Tank		Gas-filled Damper
	Seat Belt Pretensioner (Gas Generator)		Structural Reinforcements		Airbag Computer
-	-	-	-	-	-

Disable Vehicle

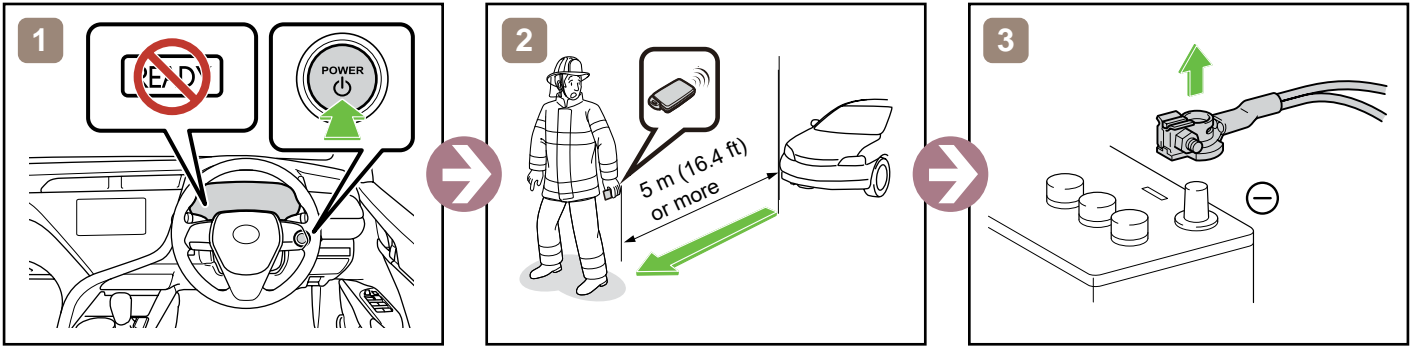

or

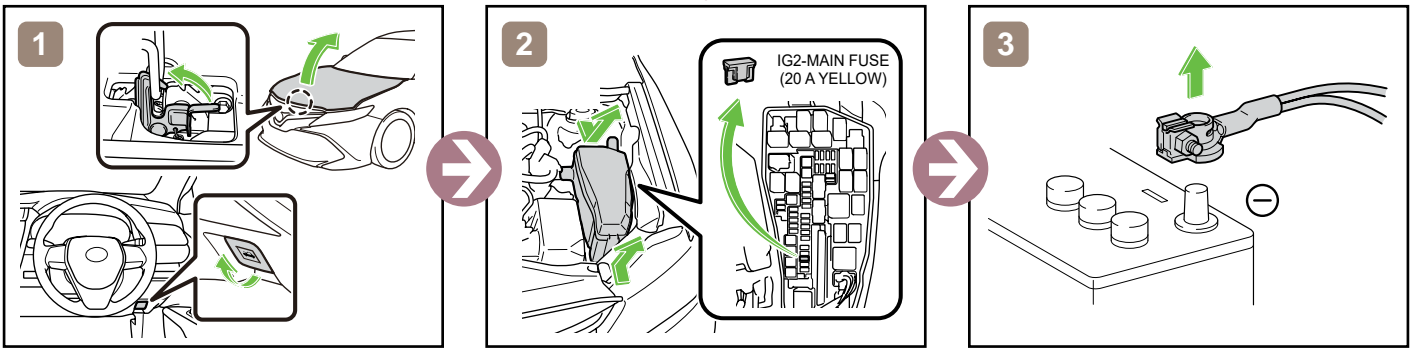

Access to 12V Battery

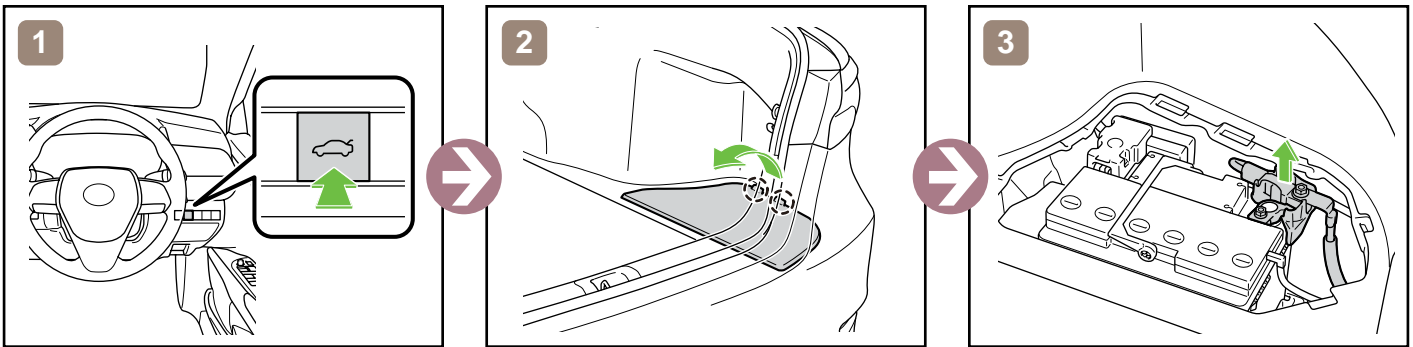

Towing Information

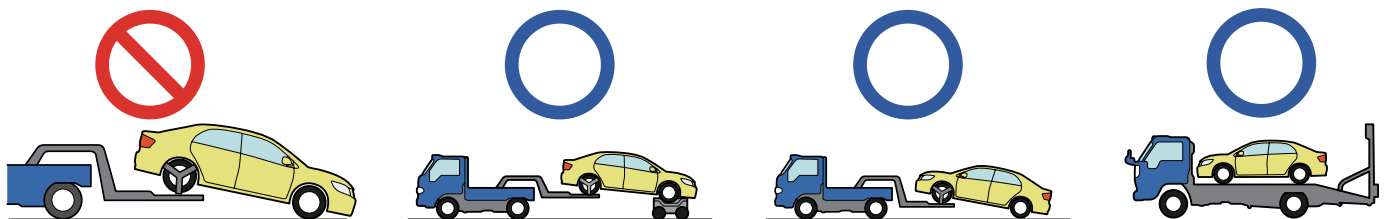

More details, please refer to "Emergency Response Guide".



TOYOTA CAMRY HYBRID
4 doors / 5 seats / sedan
2024-06

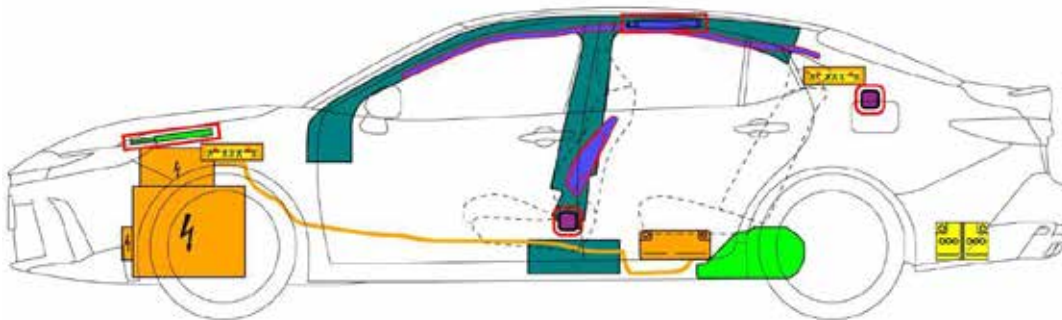
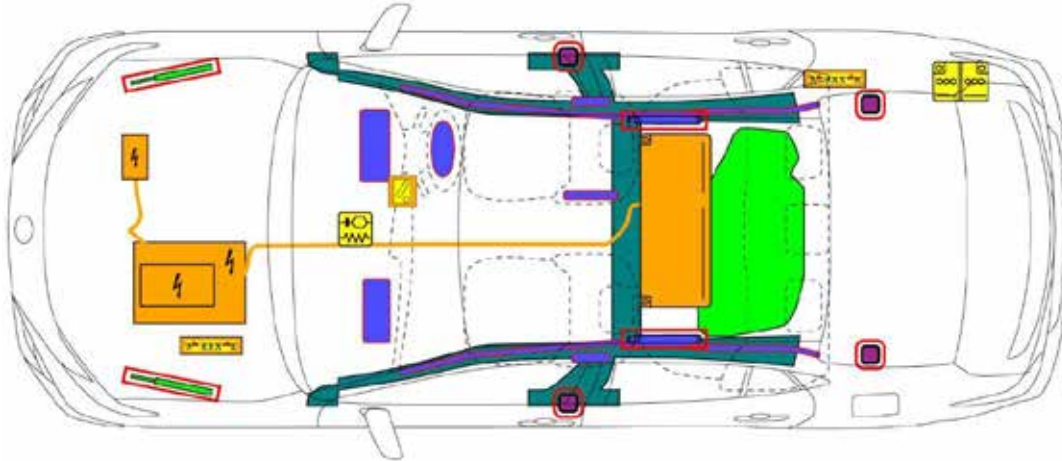
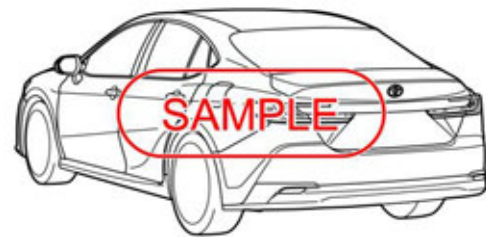
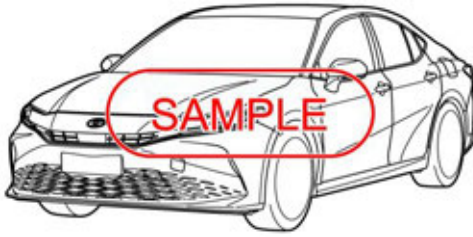

	Airbag		Stored gas inflator		Seat belt pretensioner		SRS control unit		Gas strut / Preloaded spring
	High strength zone		Battery low voltage		Fuel tank		Battery pack, high-voltage		High voltage component
	High voltage power cable		Cable cut		Low voltage device that disconnects high voltage				
	ID No.	Version No.		Version date		Page			
	CAMRYHV80	01		06 / 2024		1 / 4			

1. Identification / Recognition



Lack of engine noise does not mean vehicle is off. Silent movement or instant restart capability exists until vehicle is fully shut down.

■ Location of vehicle badges



■ Energy source: Lithium-ion battery



2. Immobilisation / Stabilisation / Lifting

■ Completely immobilize the vehicle



1) Check the wheels and engage the parking brake.

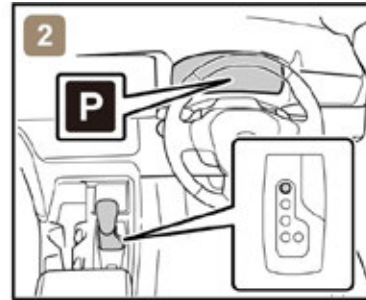

2) Move the shift lever to the park (P) position.

■ Stabilisation-lifting point

Place cribbing such as wooden blocks at the four points under the front and rear pillars.

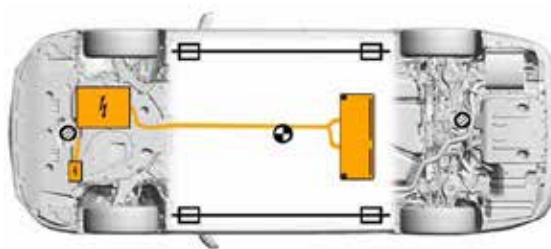

Extra Reinforced Lifting Points



Standard Jack Locations



Vehicle Center of Gravity



Do not place cribbing such as wooden blocks or rescue air lifting bags under the exhaust system, fuel system or high voltage power cables. Doing so may result in fuel leaks, fire, or electric shock.

ID No.	Version No.	Version date	Page
CAMRYHV80	01	06 / 2024	2 / 4

3. Disable direct hazards / Safety regulations

■ If any of the following systems are required to be operated, operate them **BEFORE** disconnecting the battery.

Power door lock

Power window

Trunk opener

Moon roof

Panoramic moon roof

Power seat

Power tilt and telescopic steering

Electric parking brake

When the 12 V battery is disconnected, electrical components cannot be operated.

■ Perform procedure **Main or Alternative** to completely shut off the vehicle.

<Main Procedure>

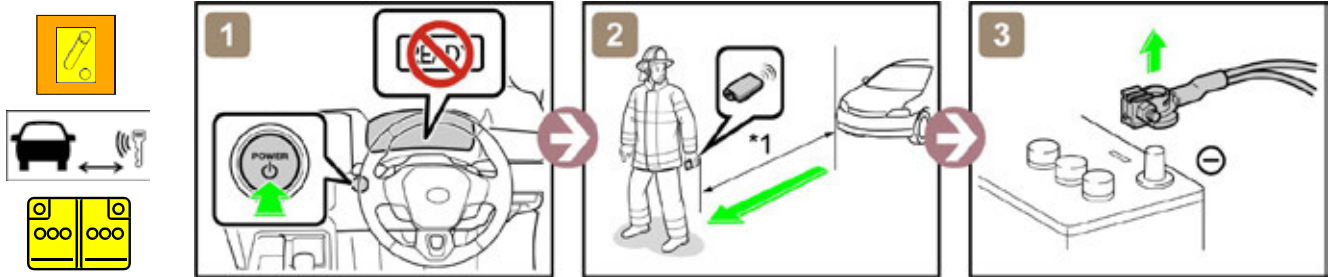

*1: 5 m (16.4 ft) or more

<Alternative Procedure>

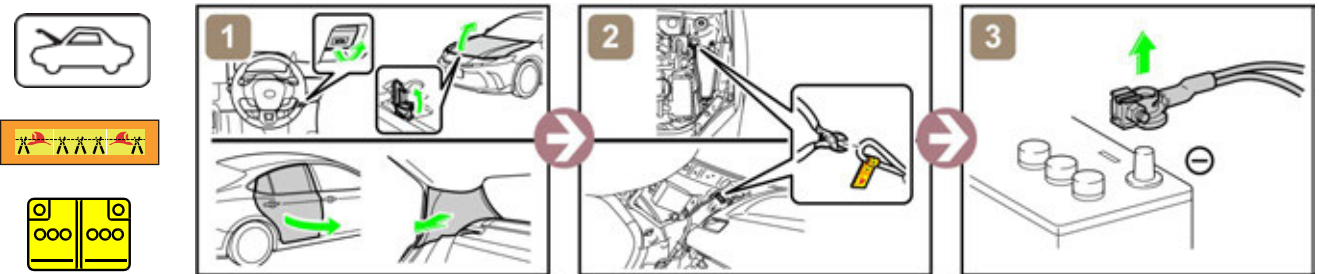

In the event of an accident in which the airbags are deployed, the high-voltage system will be automatically deactivated.

■ Access to 12 V Battery

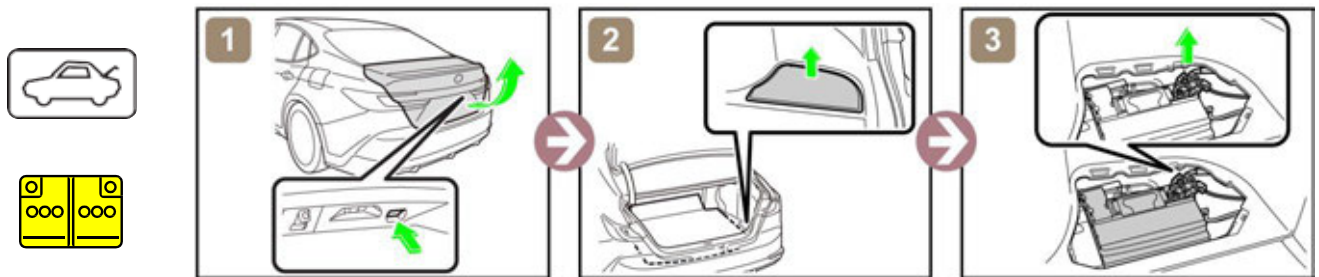

4. Access to the occupants

■ Window Glass

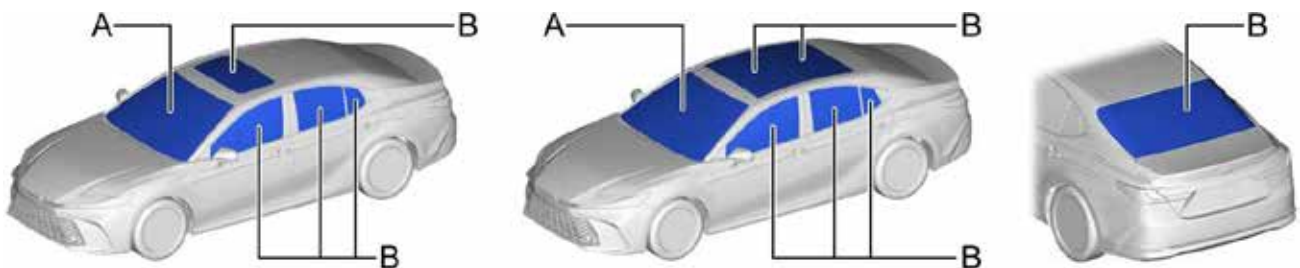

A	Laminated	B	Tempered
---	-----------	---	----------

ID No.	Version No.	Version date	Page
CAMRYHV80	01	06 / 2024	3 / 4

5. Stored energy / Liquids / Gases / Solids



High Voltage Li-ion Battery



12 V Battery



Gasoline Tank: 50.0 L



- Always wear appropriate personal protective equipment (PPE) when dealing with any of these items.
- Never breach or remove the battery assembly cover under any circumstances, including fire. Doing so may result in serious injury or death from severe burns or electric shock.

6. In case of fire



USE COPIOUS AMOUNTS OF WATER

If it is difficult to apply copious amounts of water to the high voltage battery, it is recommended to allow the high voltage battery to burn itself out.



RE-IGNITION POSSIBLE !



Gas strut / Preloaded spring

As it is possible for a gas strut / preloaded spring to become a projectile, refer to the component layout drawing

7. In case of submersion



Do not touch any of the high-voltage components or cables, including the service plug, while the vehicle is submerged. Doing so may result in electric shock.
Work on the vehicle only after the vehicle has been pulled out of the water.

8. Towing / Transportation / Storage

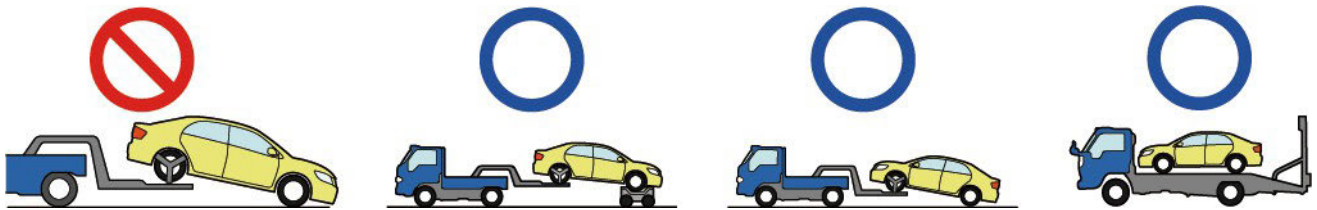

RE-IGNITION POSSIBLE !

Store the vehicle at a safe distance (15 m (49.2 ft) or more) from other vehicles.

9. Important additional information

For further details, please refer to "Emergency Response Guide".

ID No.	Version No.	Version date	Page
CAMRYHV80	01	06 / 2024	4 / 4

COASTER
LONG BODY /
RHD
2017-1

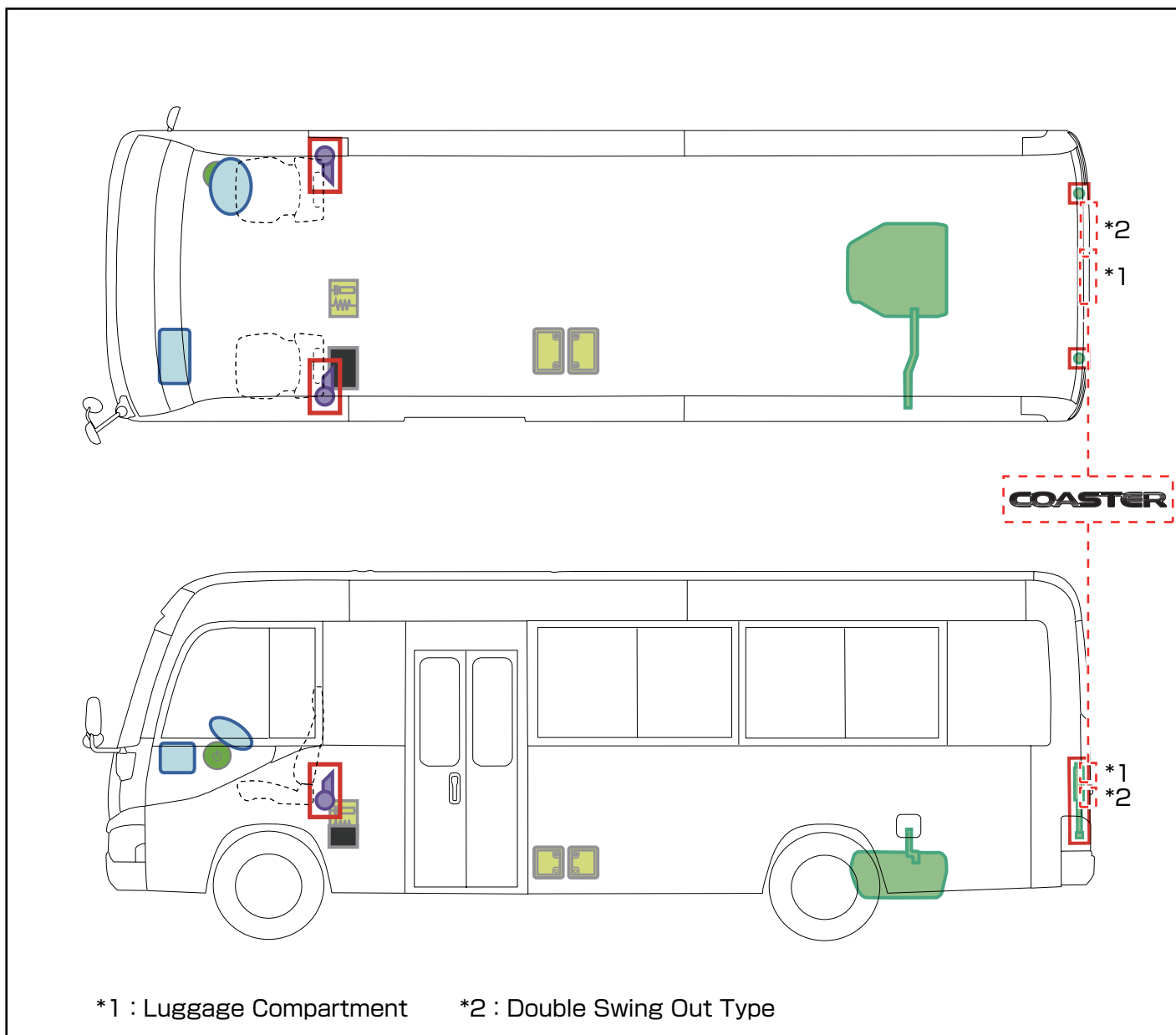
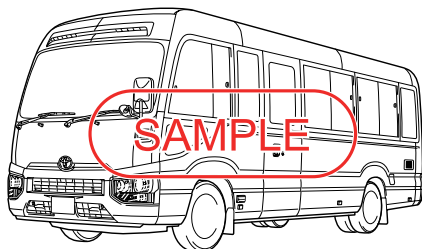

	IG/POWER SW		Fuse Box		12V Battery
	Airbag (incl. Inflator)		Fuel Tank		Gas-filled Damper
	Seat Belt Pretensioner (Gas Generator)		Airbag Computer	—	—
—	—	—	—	—	—
—	—	—	—	—	—

Disable Vehicle

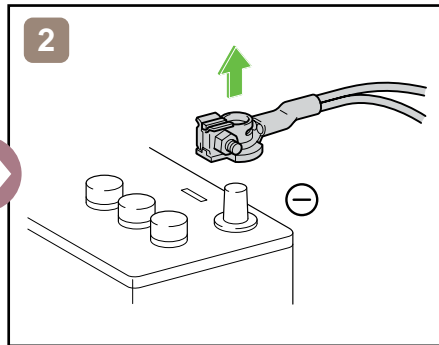
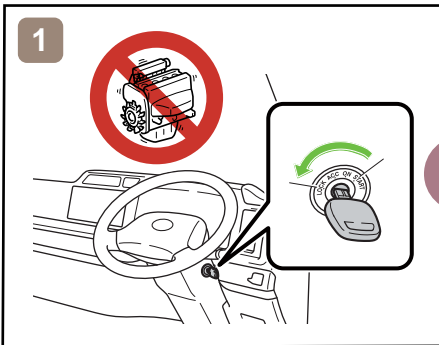

or

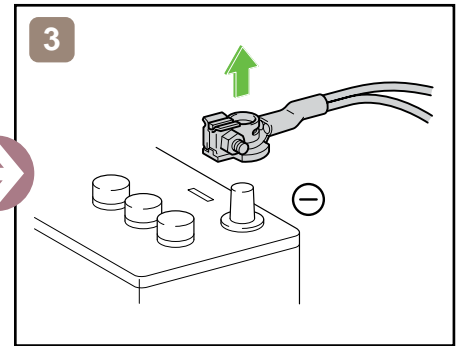
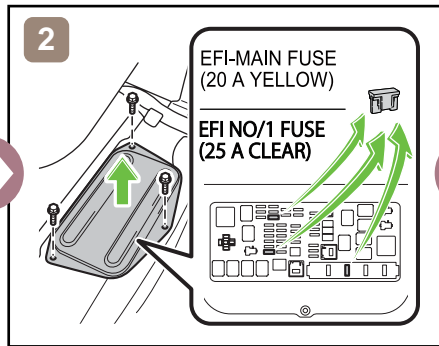
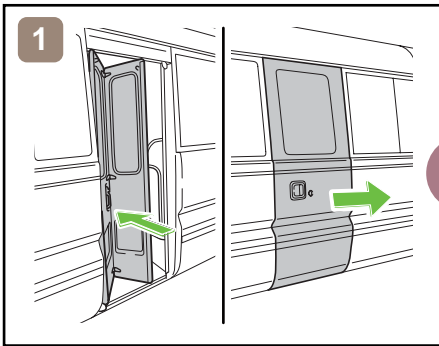

Access to 12V Battery

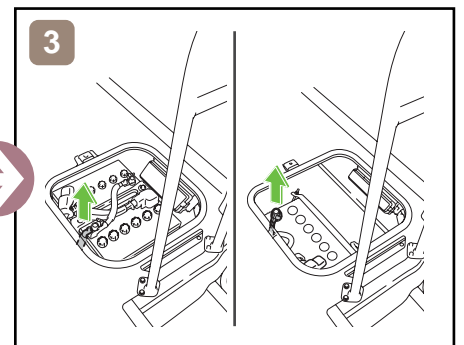
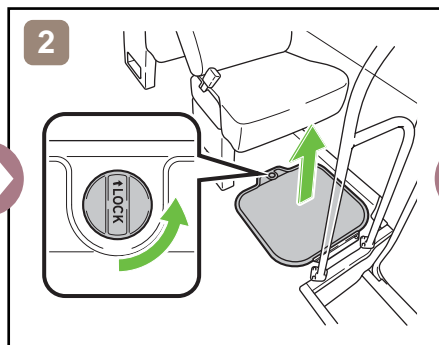
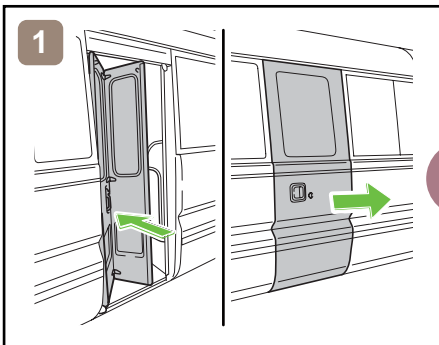

Towing Information

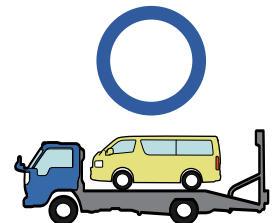
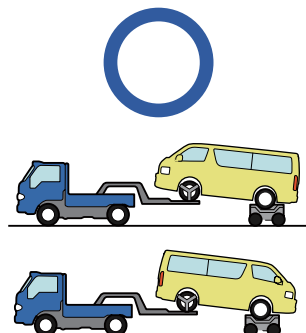
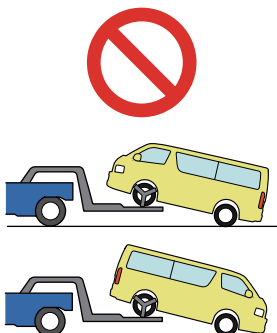

More details, please refer to "Emergency Response Guide".

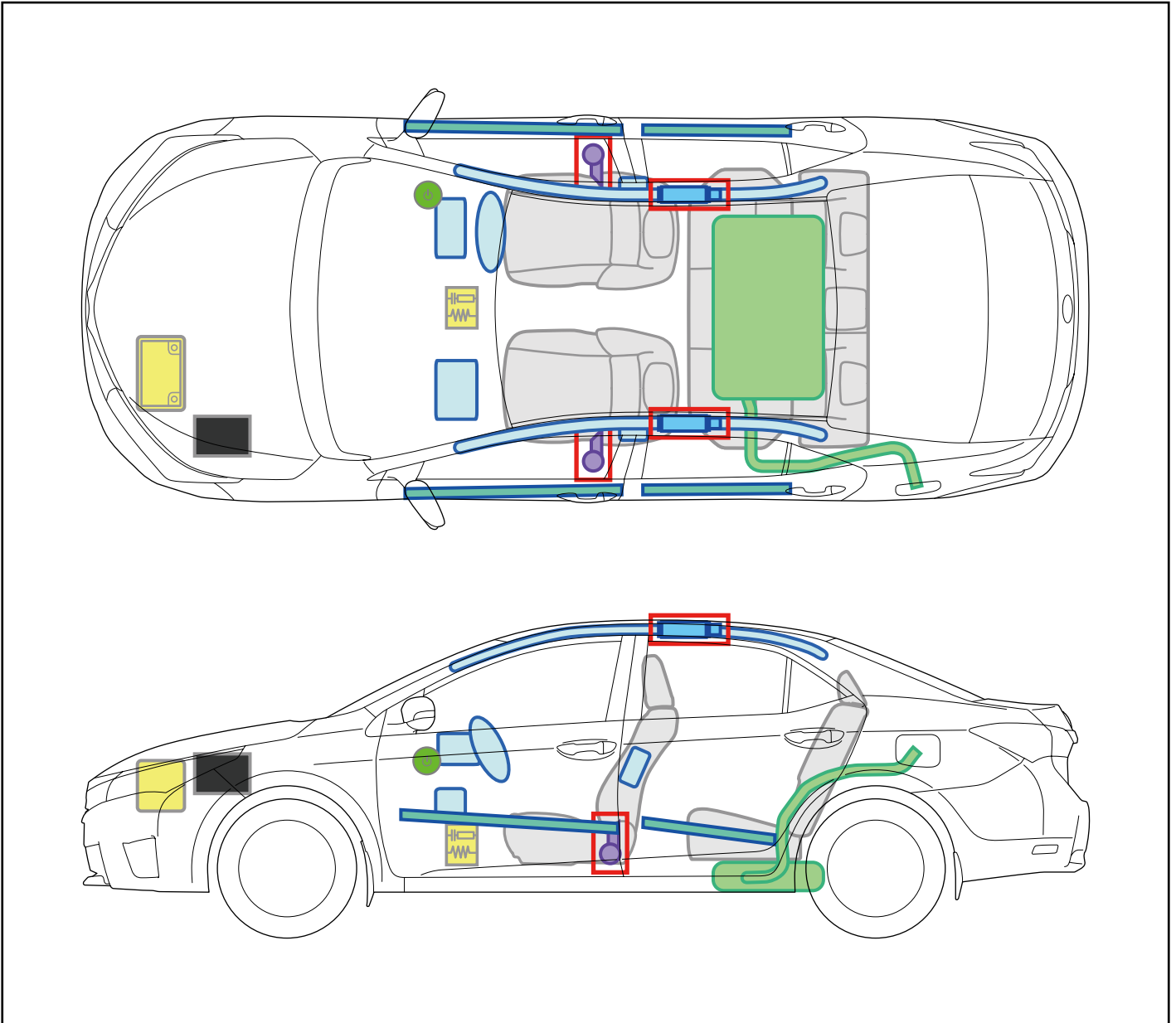

	IG/ENGINE SW		Fuse Box
	12V Battery		Airbag
	Gas Generator		Fuel Tank
	Seat Belt Pretensioner		Structural Reinforcements
	Control Unit	-	-

Disable Vehicle

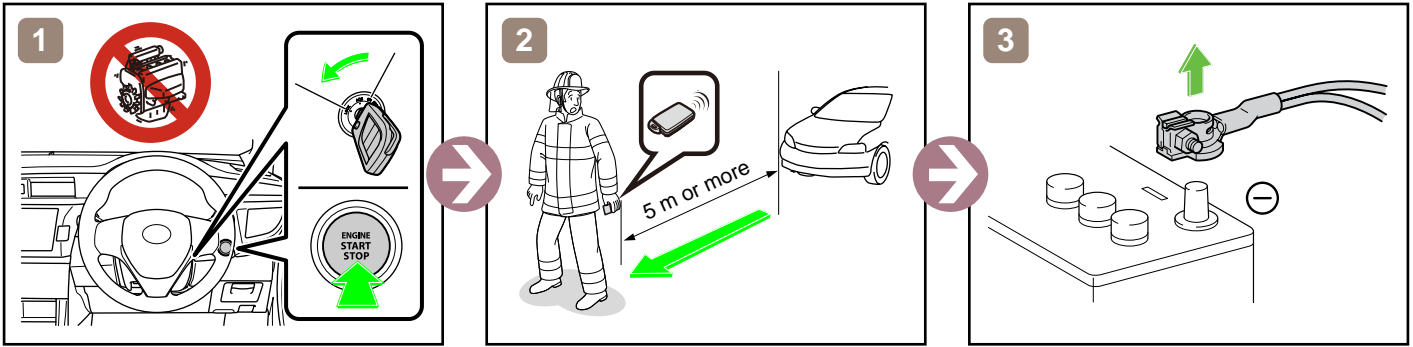

or

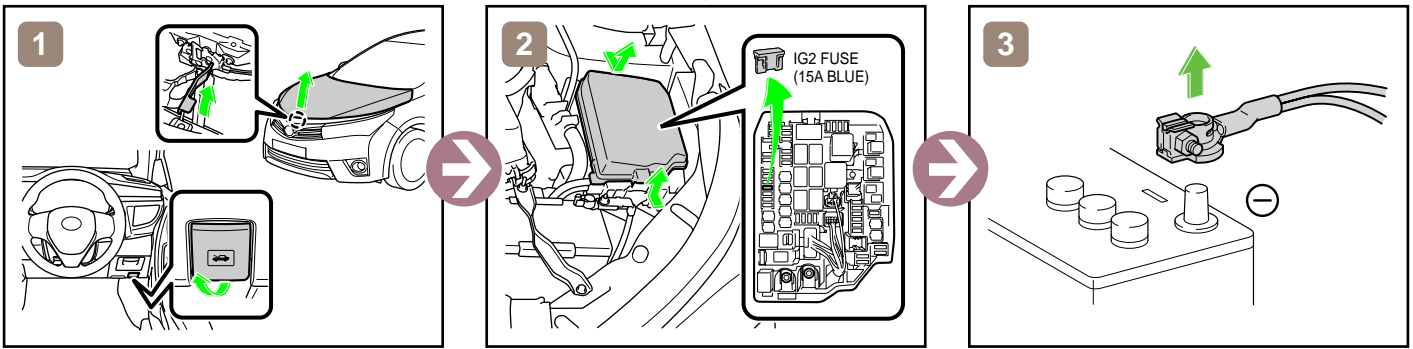

Access to 12V Battery

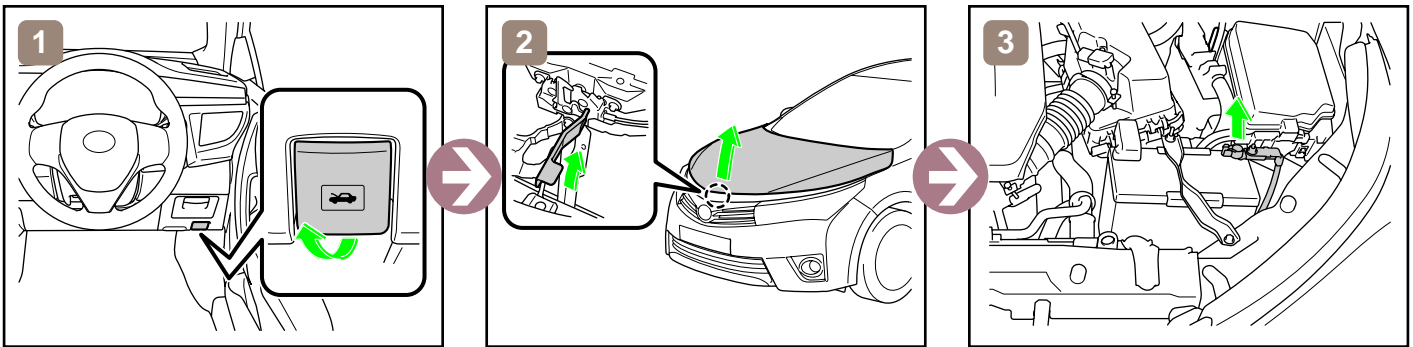

Towing Information

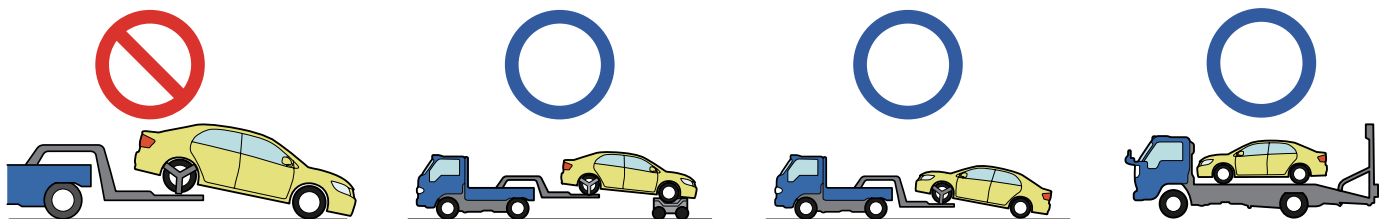









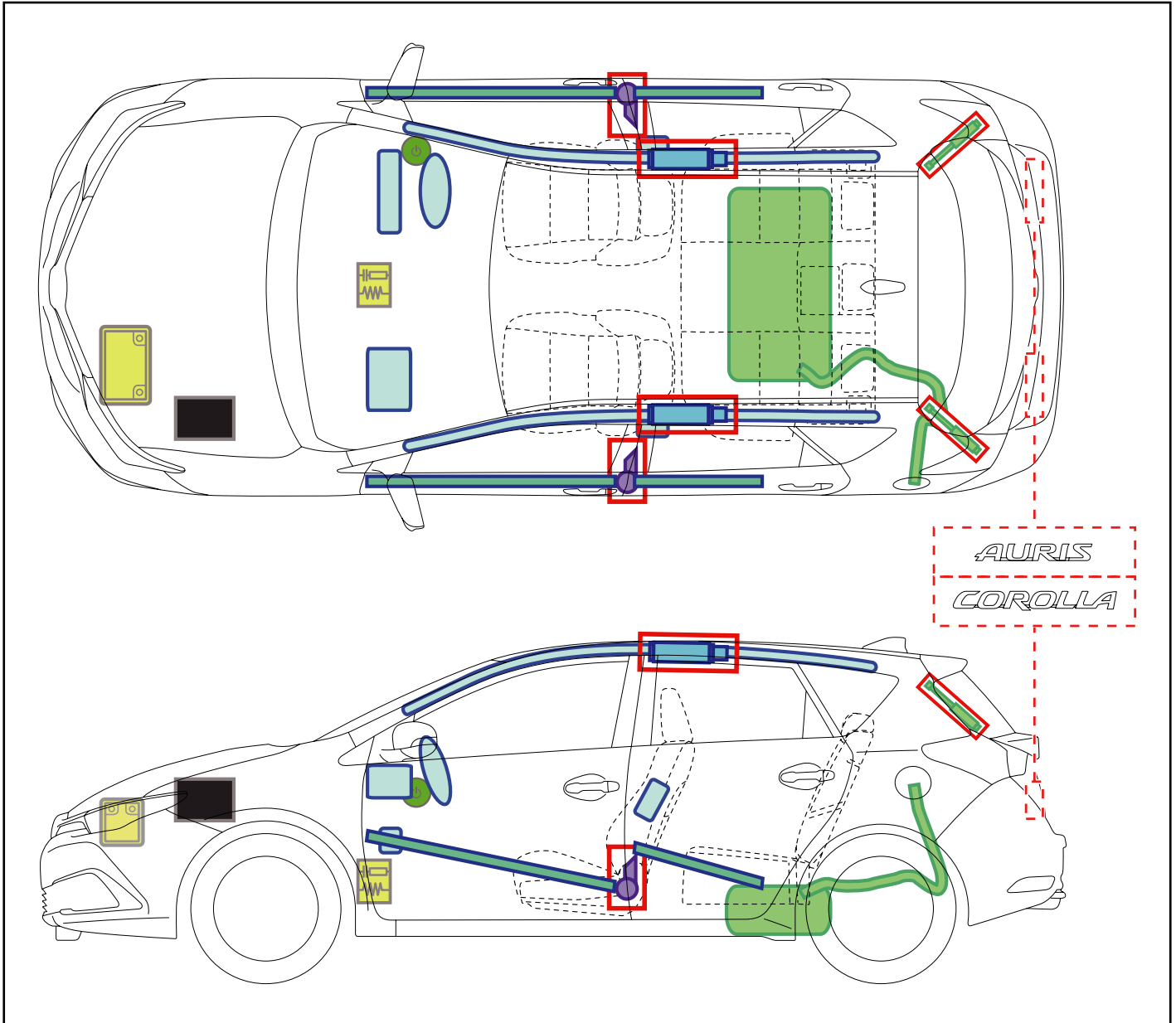

More details, please refer to "Emergency Response Guide".

COROLLA

HATCHBACK

2013-6



	IG/ENGINE SW		Fuse Box		12V Battery
	Airbag (incl. Inflator)		Inflator		Fuel Tank
	Gas-filled Damper		Seat Belt Pretensioner (Gas Generator)		Structural Reinforcements
	Airbag Computer	-	-	-	-
-	-	-	-	-	-

Disable Vehicle

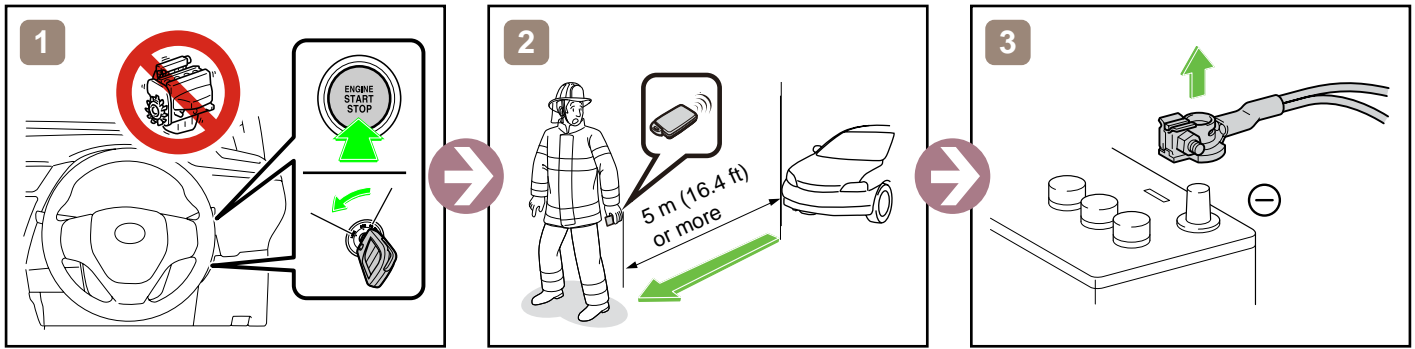

or

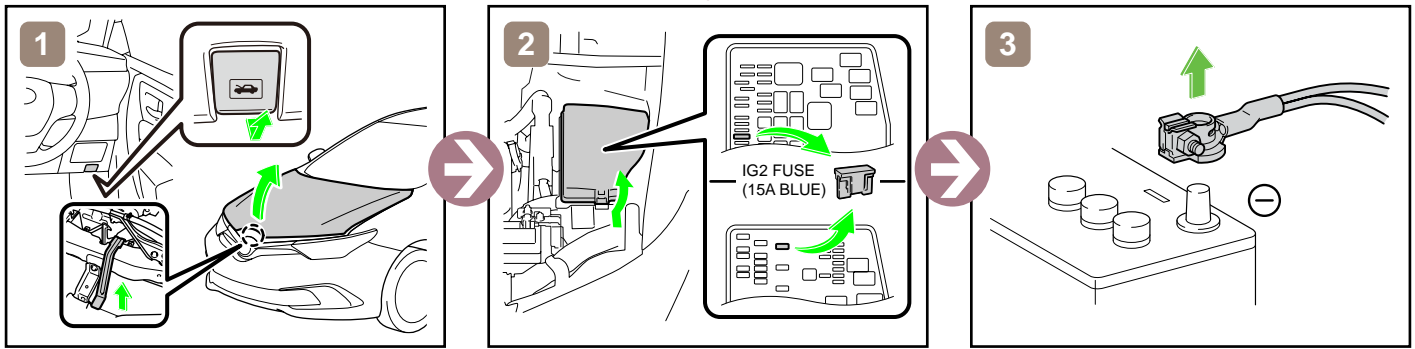

Access to 12V Battery

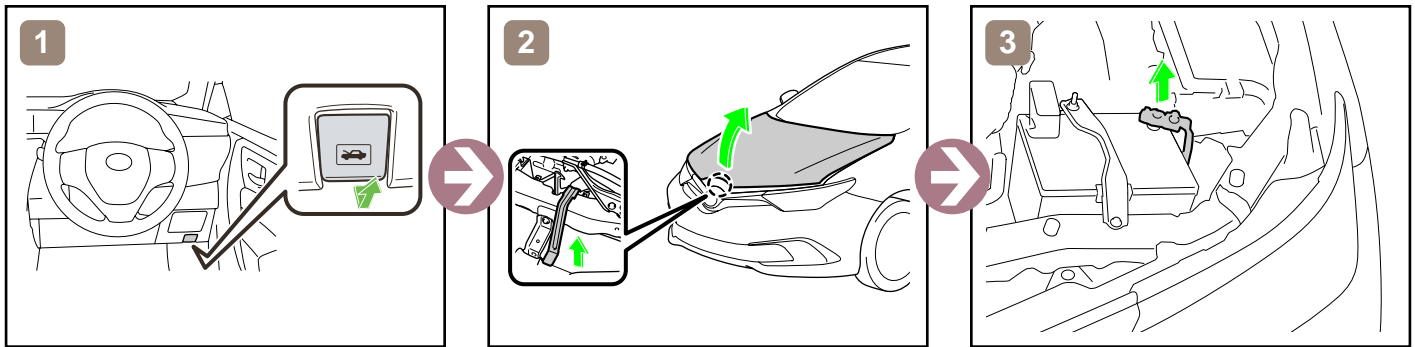

Towing Information

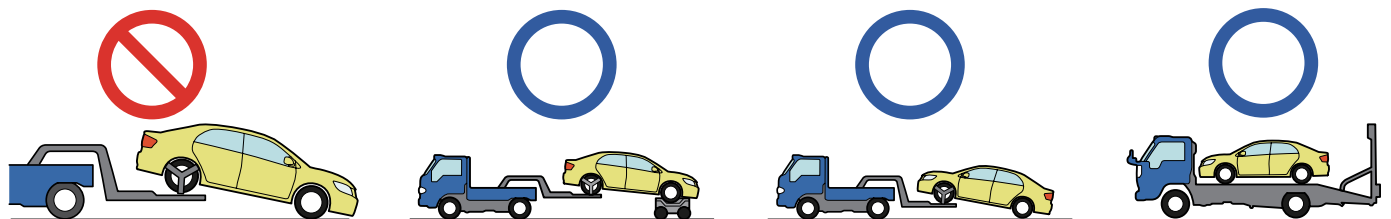

More details, please refer to "Emergency Response Guide".

COROLLA HYBRID

2016-4

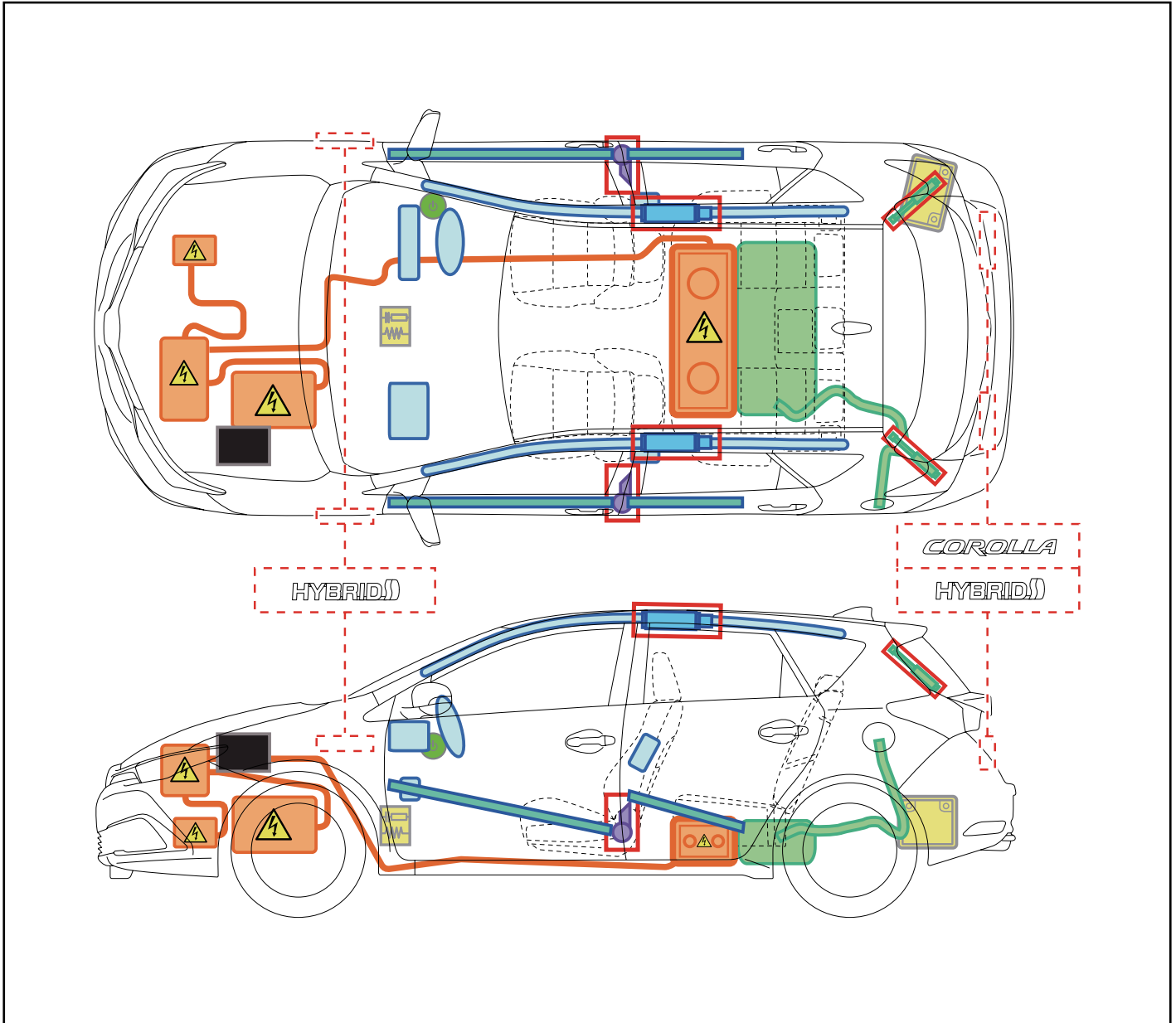
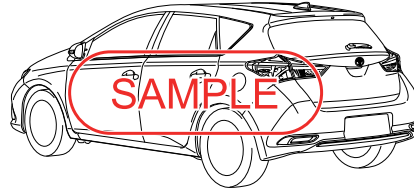
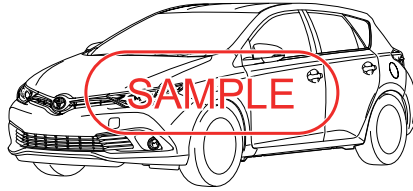

	POWER SW		Fuse Box		12V Battery
	Airbag (incl. Inflator)		Inflator		High Voltage Battery
	High Voltage Components		Fuel Tank		Gas-filled Damper
	Seat Belt Pretensioner (Gas Generator)		Structural Reinforcements		Airbag Computer
-	-	-	-	-	-

Disable Vehicle

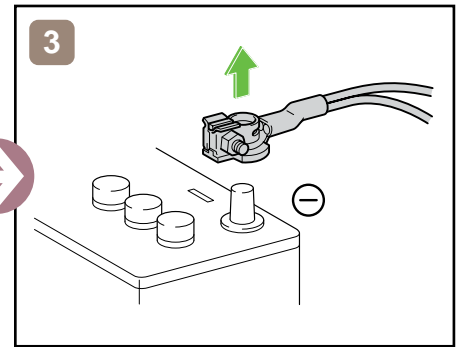
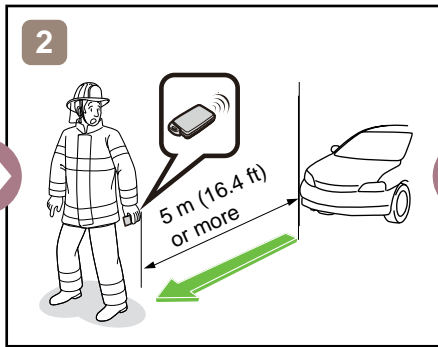
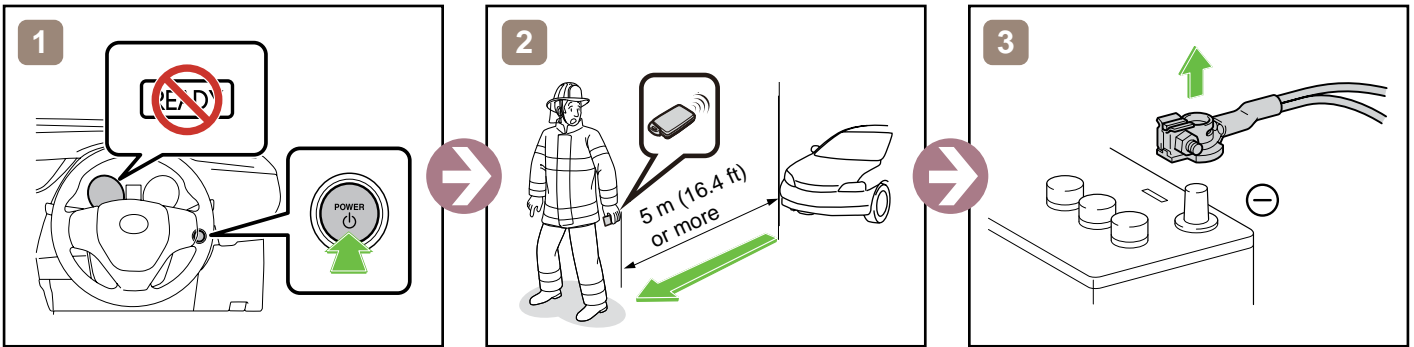

or

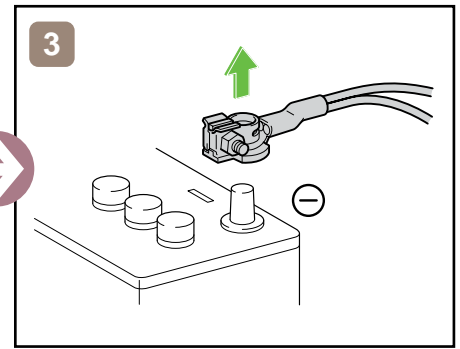
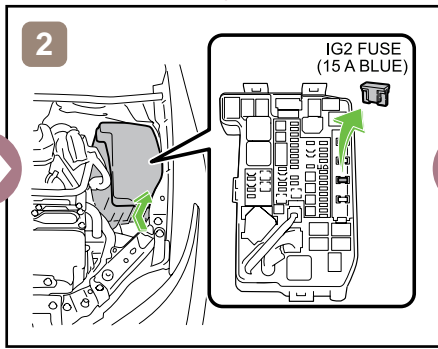
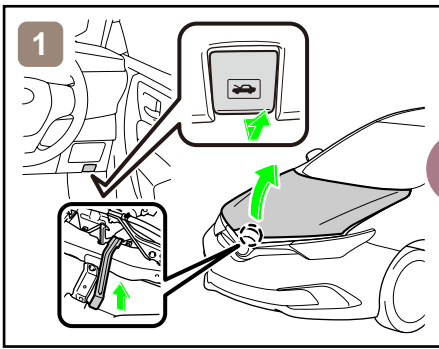

Access to 12V Battery

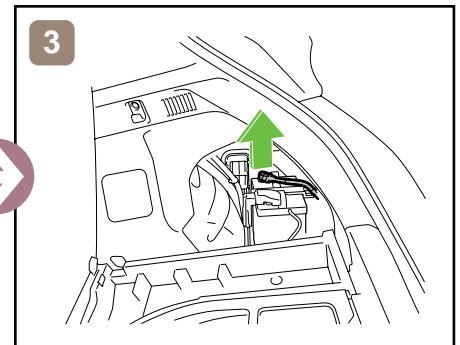
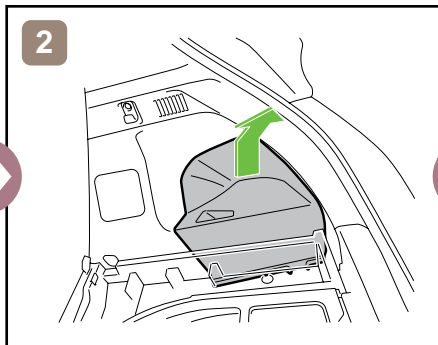
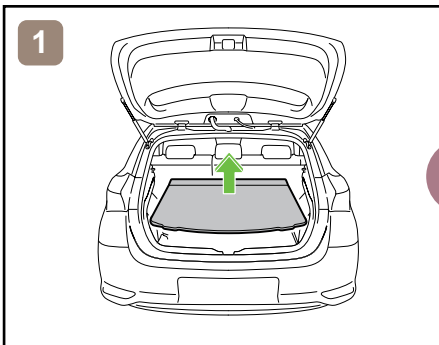

Towing Information

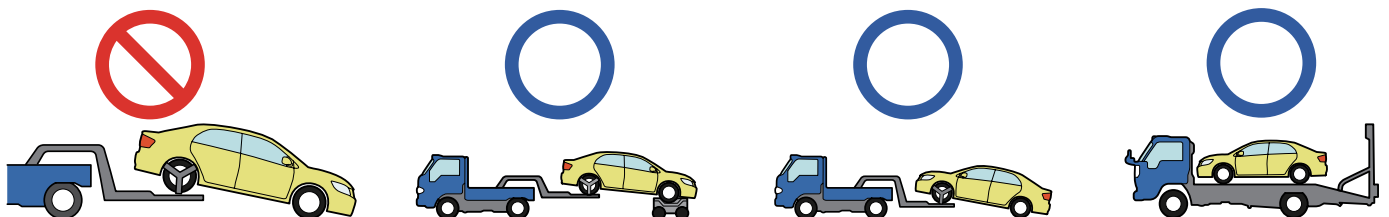

More details, please refer to "Emergency Response Guide".

COROLLA

HATCHBACK / RHD

2018-6

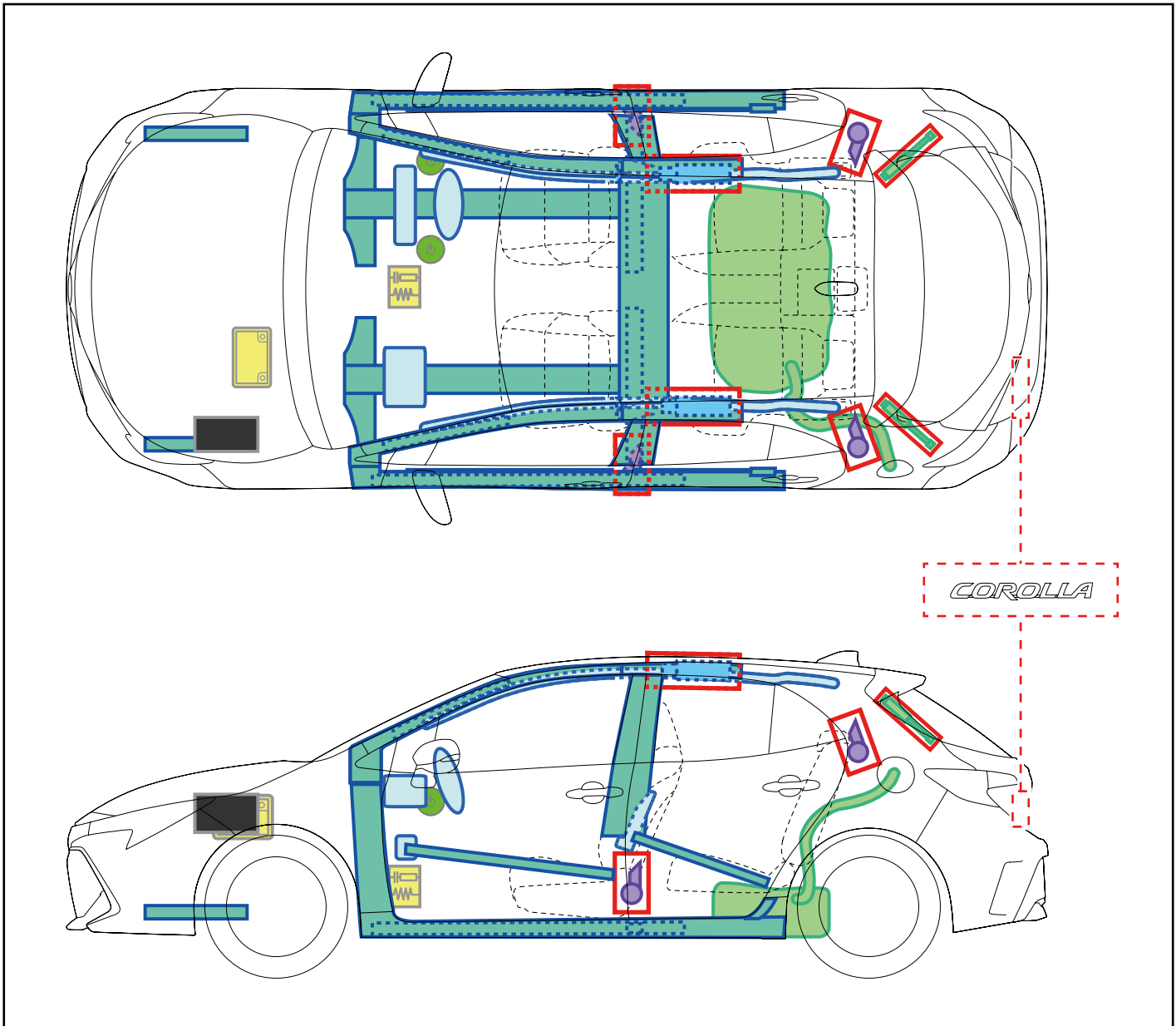
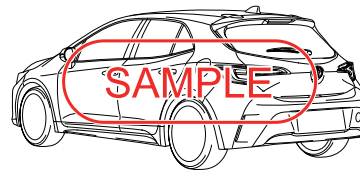
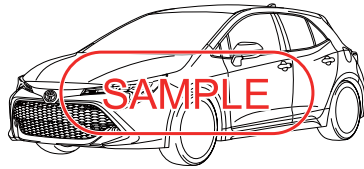

	IG/POWER SW		Fuse Box		12V Battery
	Airbag (incl. Inflator)		Inflator		Fuel Tank
	Gas-filled Damper		Seat Belt Pretensioner (Gas Generator)		Structural Reinforcements
	Airbag Computer	-	-	-	-
-	-	-	-	-	-

Disable Vehicle

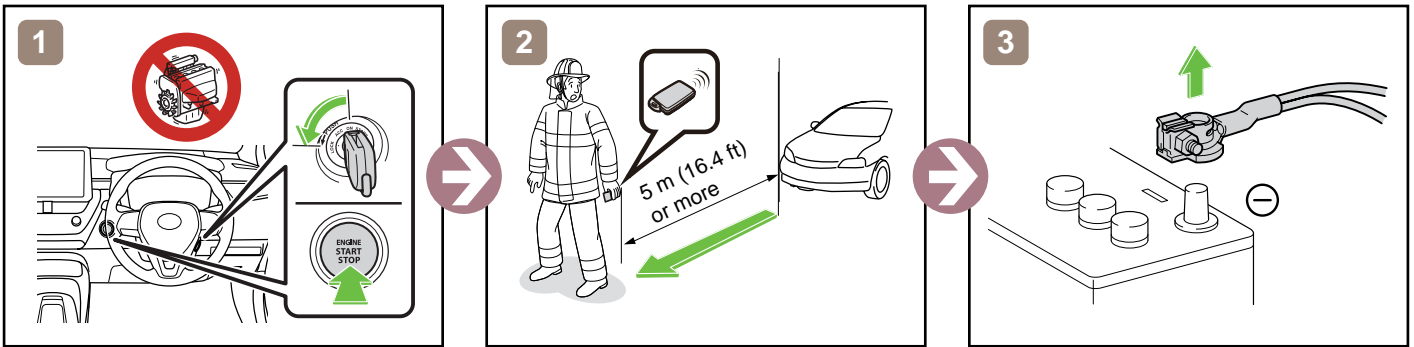

or

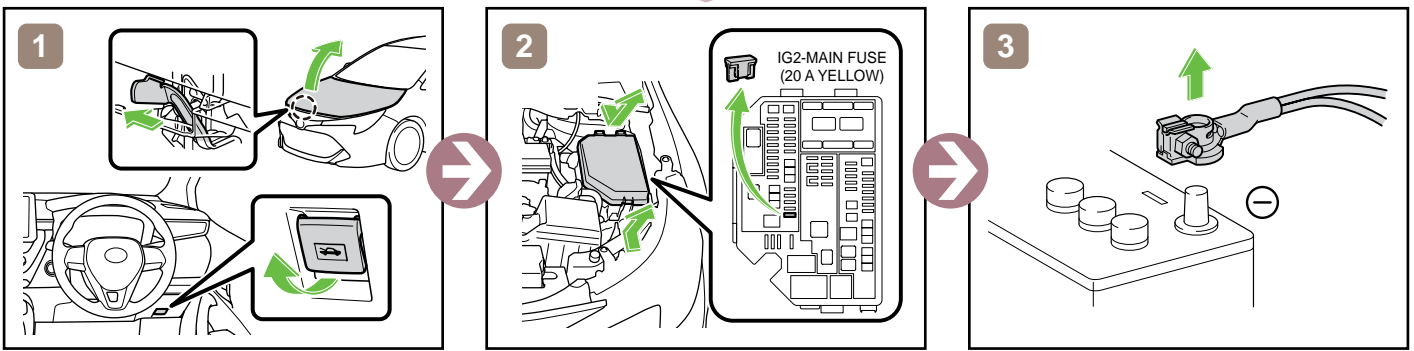

Access to 12V Battery

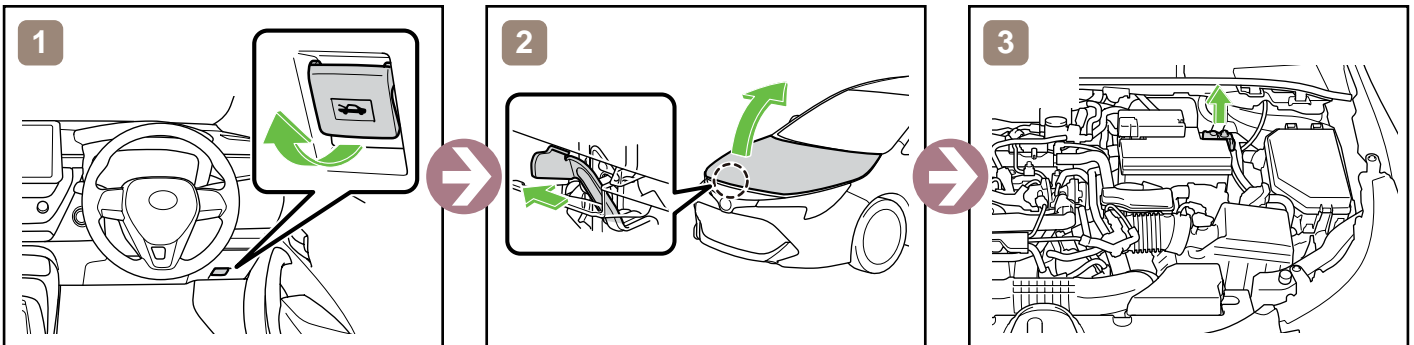

Towing Information

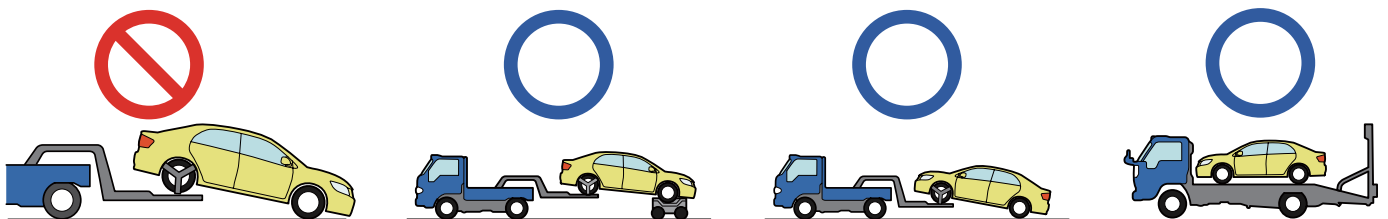

More details, please refer to "Emergency Response Guide".

COROLLA HYBRID

HATCHBACK / RHD
(ZWE21#)

2018-6

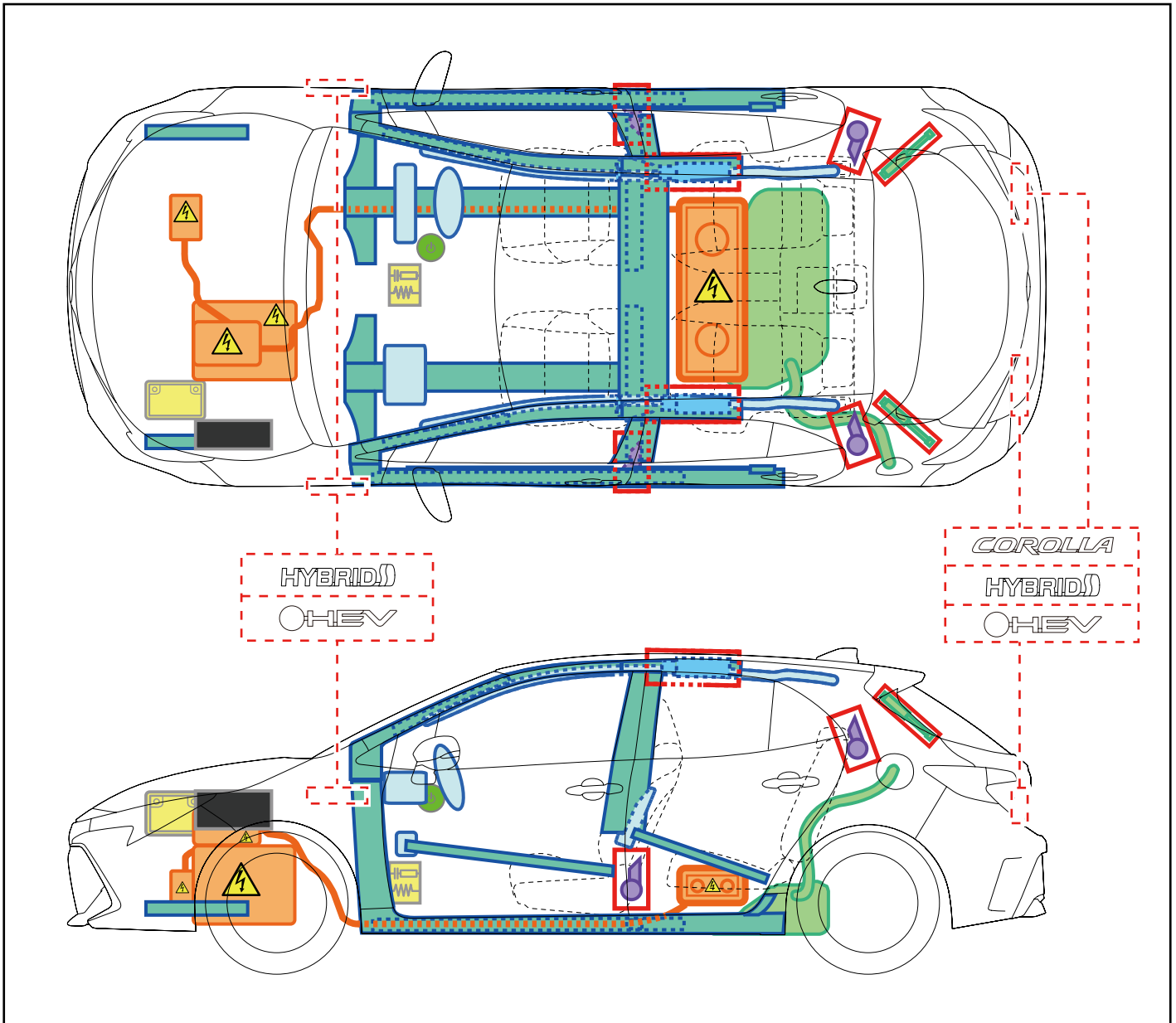
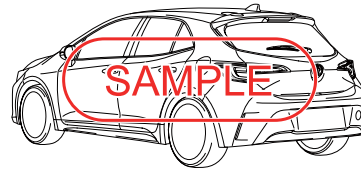
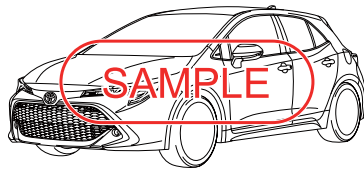

	IG/POWER SW		Fuse Box		12V Battery
	Airbag (incl. Inflator)		Inflator		High Voltage Battery
	High Voltage Components		Fuel Tank		Gas-filled Damper
	Seat Belt Pretensioner (Gas Generator)		Structural Reinforcements		Airbag Computer
-	-	-	-	-	-



Disable Vehicle

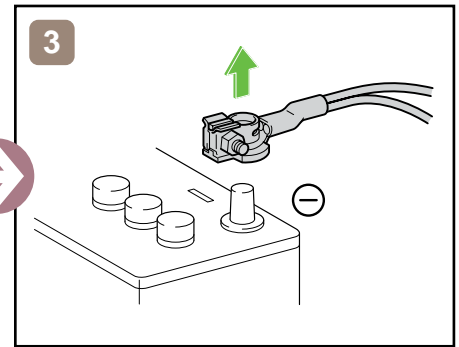
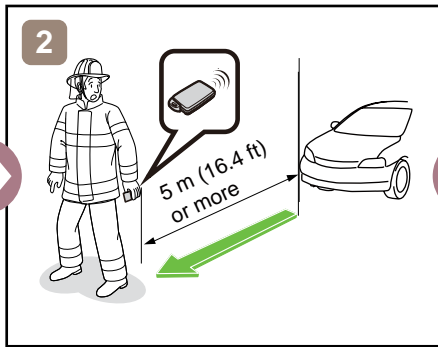
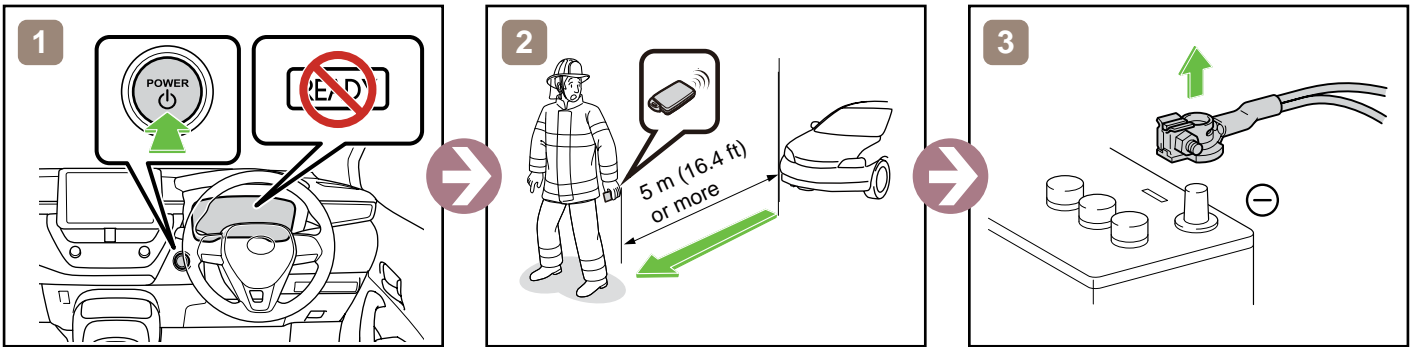

or

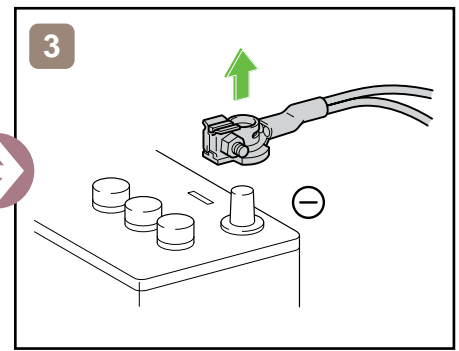
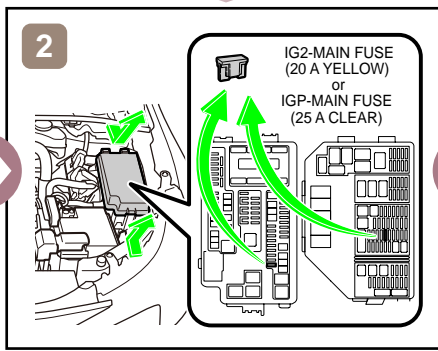
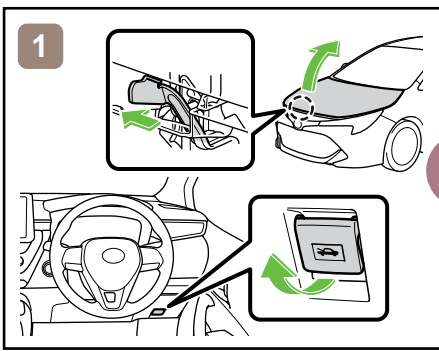

Access to 12V Battery

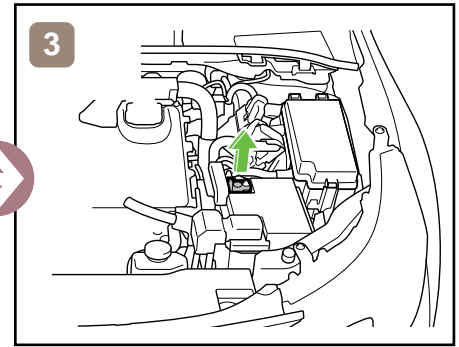
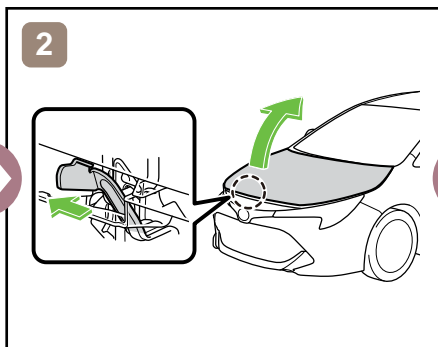
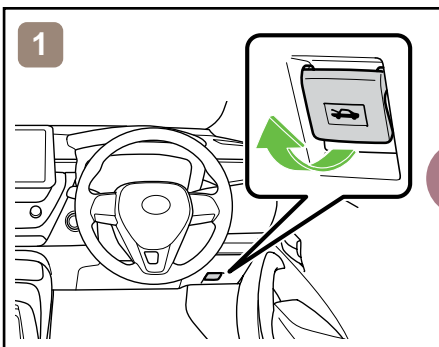

Towing Information

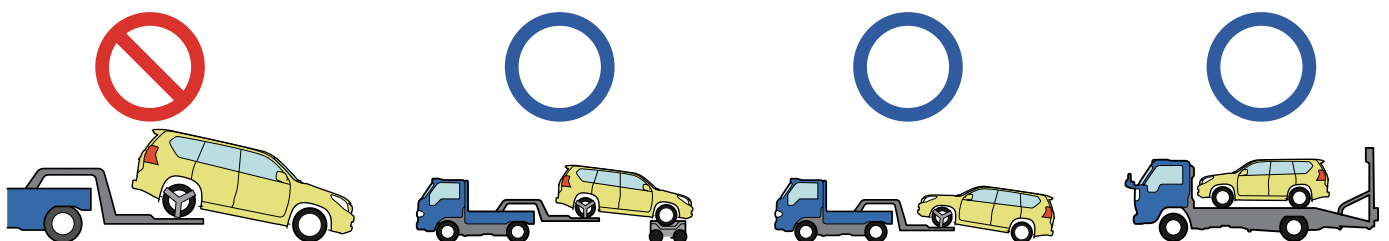









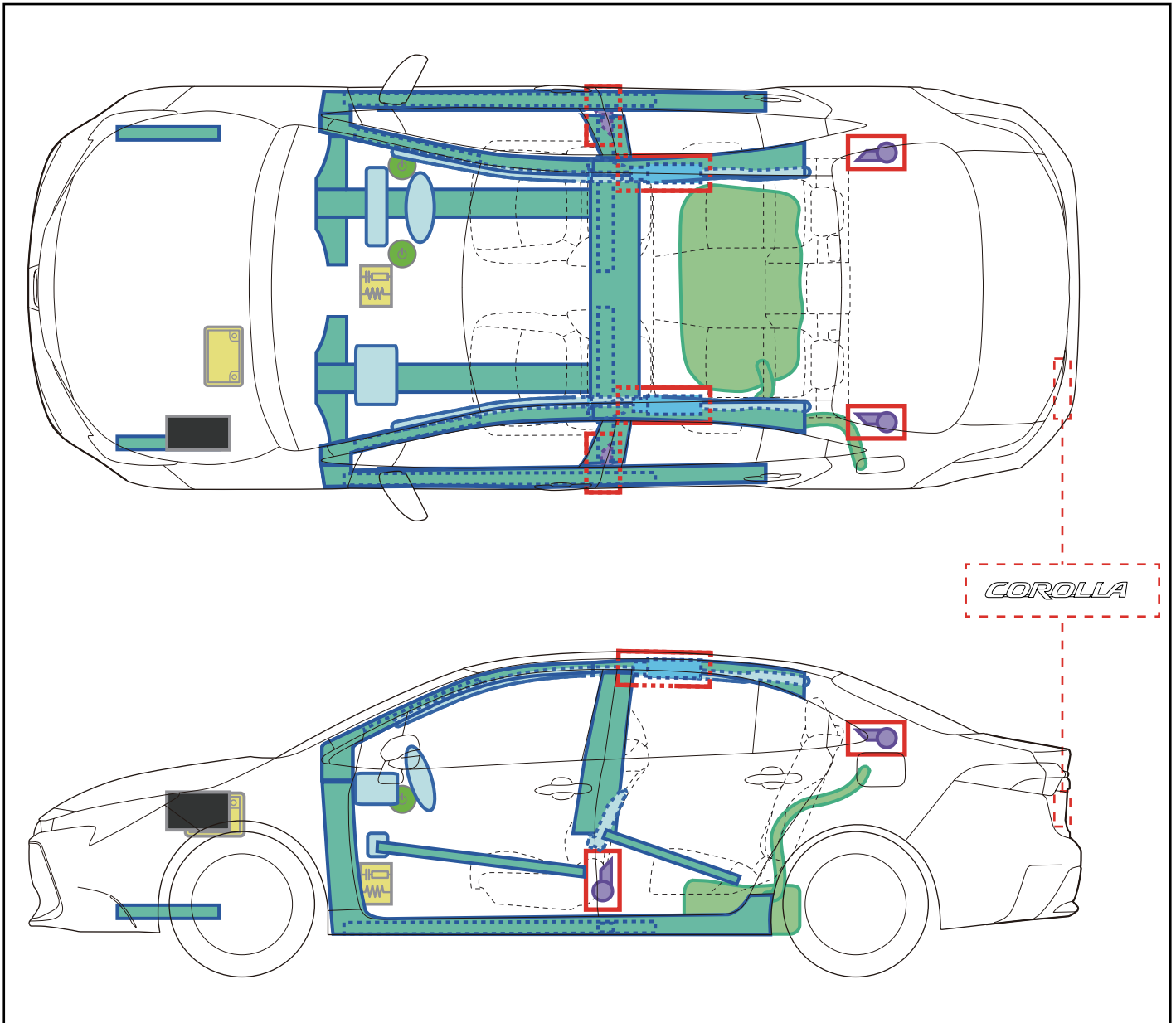
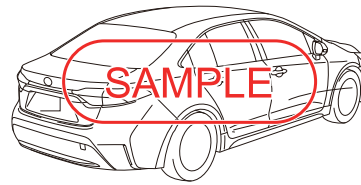
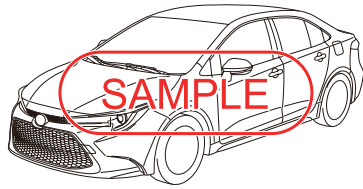

More details, please refer to "Emergency Response Guide".

COROLLA

SEDAN / RHD
(MZEA1#)

2019-8



	IG/POWER SW		Fuse Box		12V Battery
	Airbag (incl. Inflator)		Inflator		Fuel Tank
	Seat Belt Pretensioner (Gas Generator)		Structural Reinforcements		Airbag Computer
-	-	-	-	-	-
-	-	-	-	-	-

Disable Vehicle

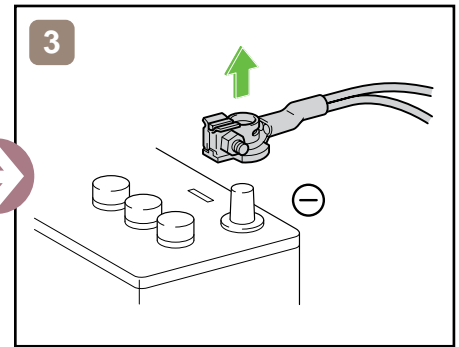
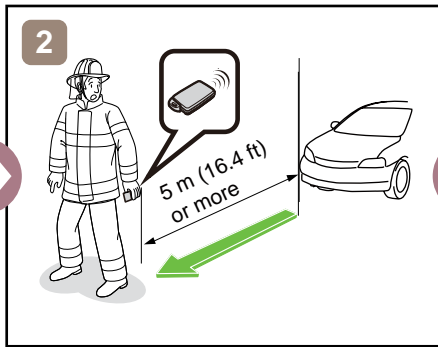
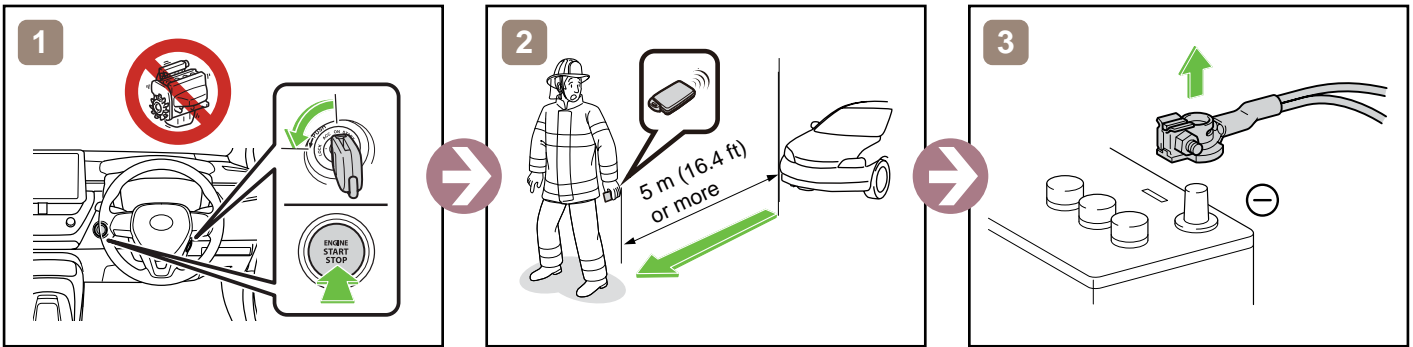

or

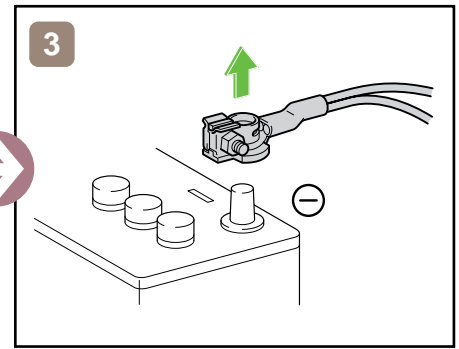
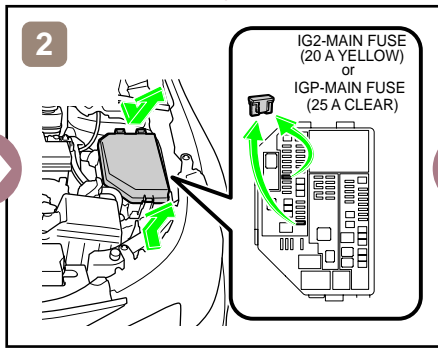
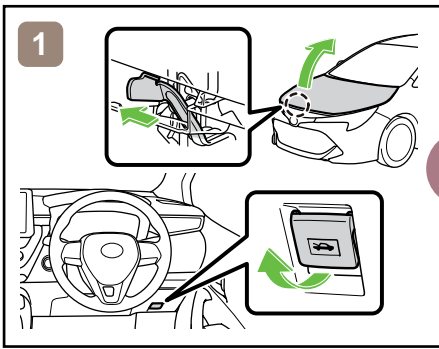

Access to 12V Battery

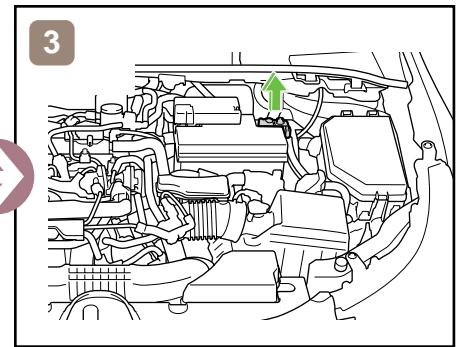
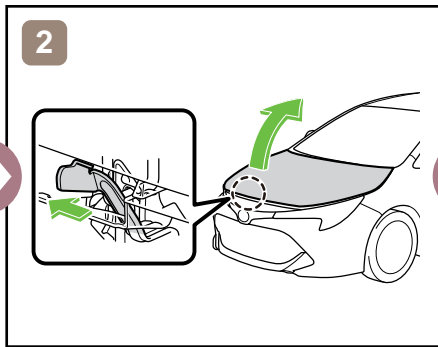
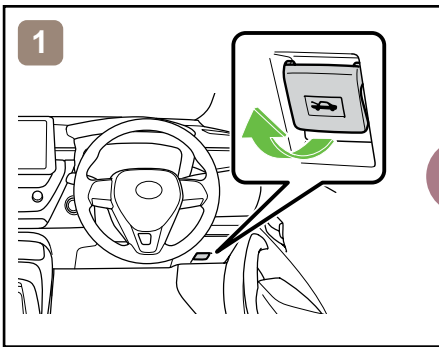

Towing Information

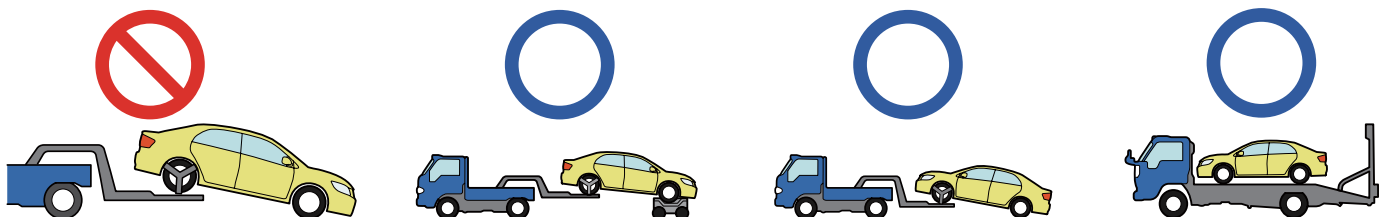

More details, please refer to "Emergency Response Guide".

COROLLA HYBRID

SEDAN / RHD

2019-1

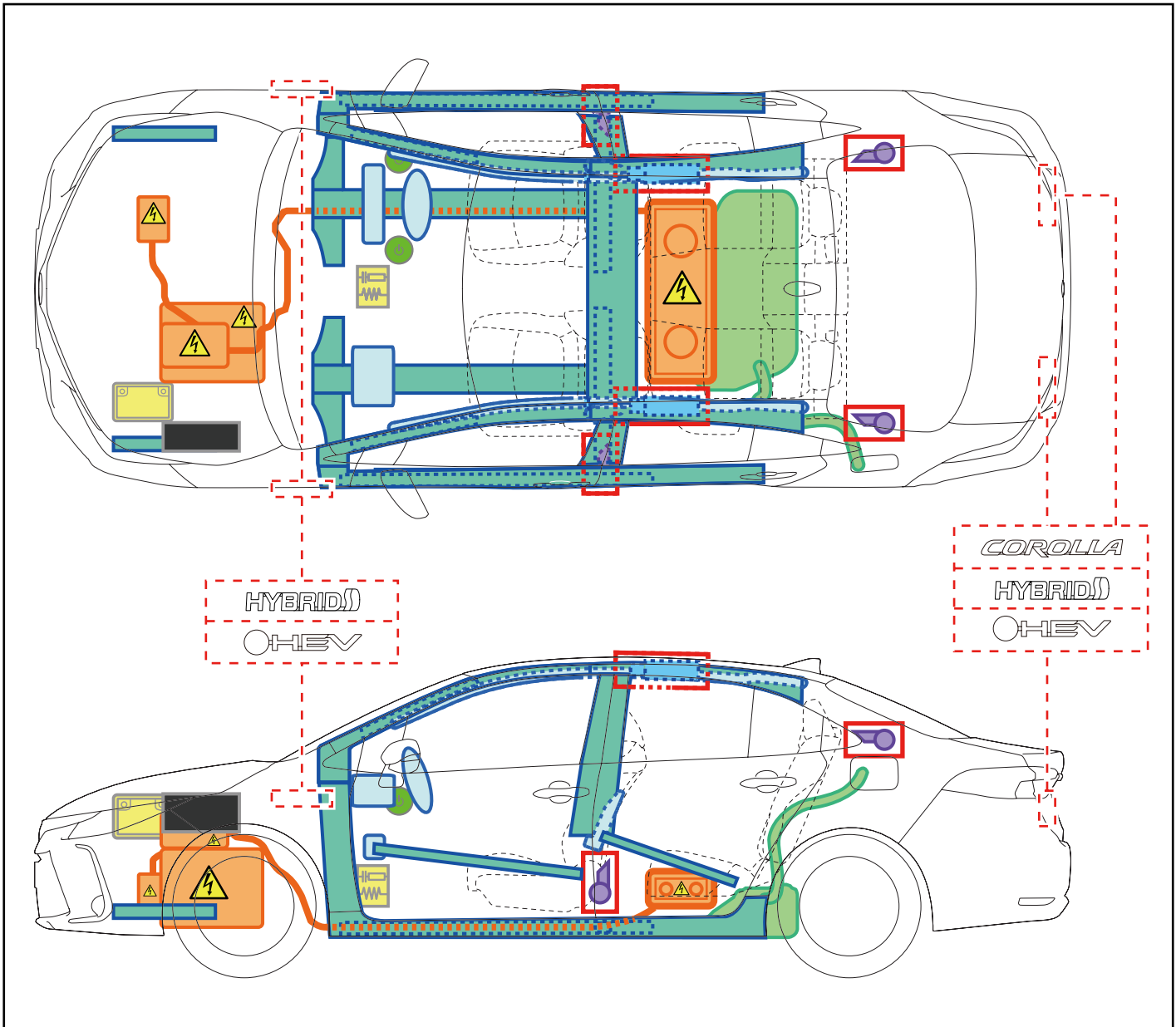
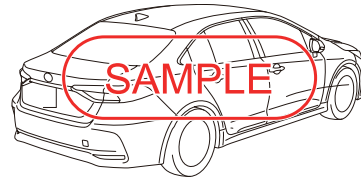
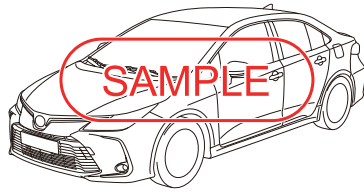

	IG/POWER SW		Fuse Box		12V Battery
	Airbag (incl. Inflator)		Inflator		High Voltage Battery
	High Voltage Components		Fuel Tank		Seat Belt Pretensioner (Gas Generator)
	Structural Reinforcements		Airbag Computer	-	-
-	-	-	-	-	-

Disable Vehicle

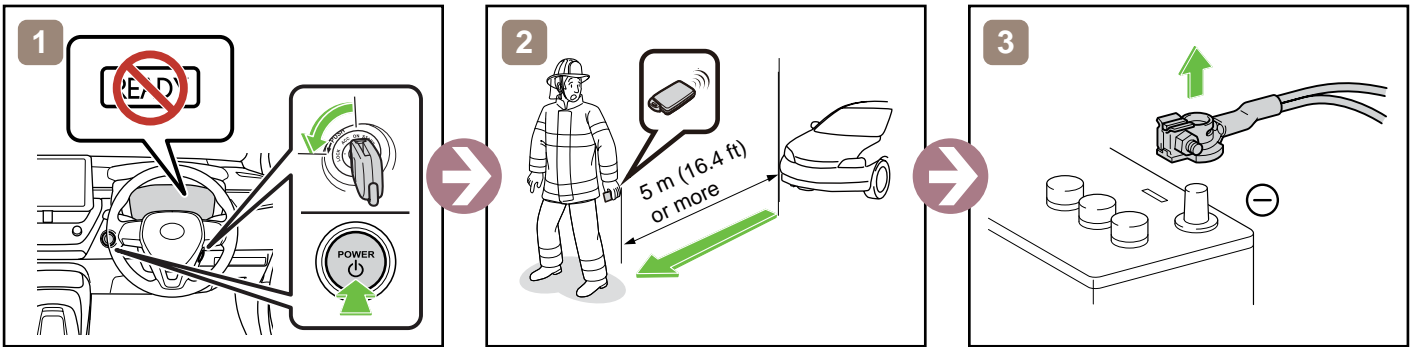

or

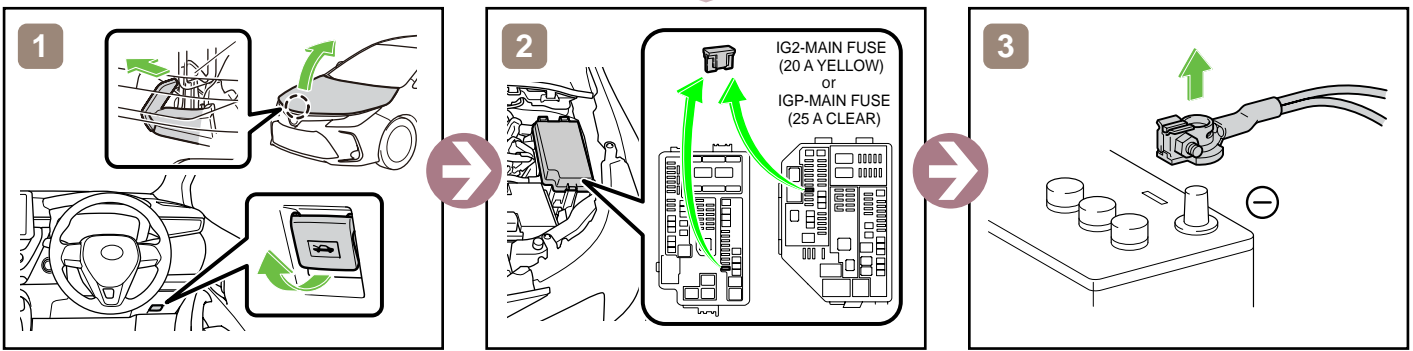

Access to 12V Battery

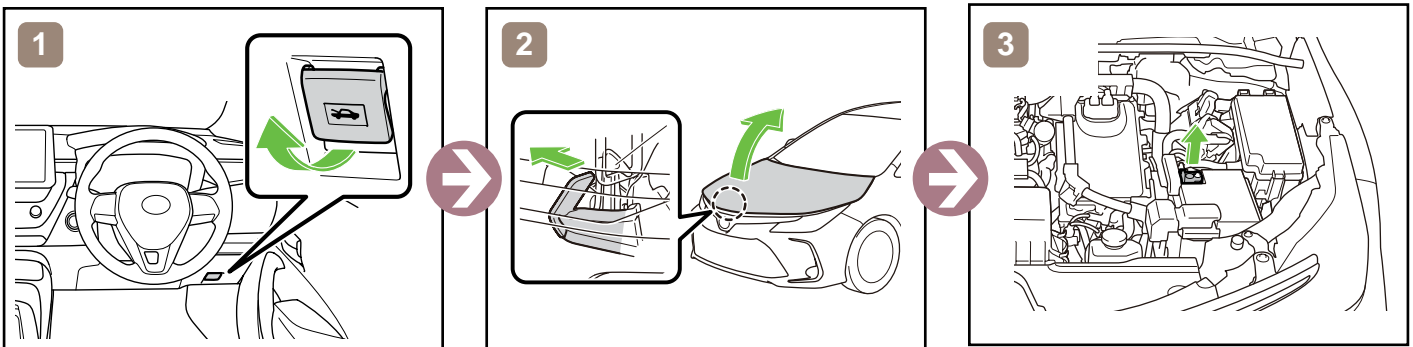

Towing Information

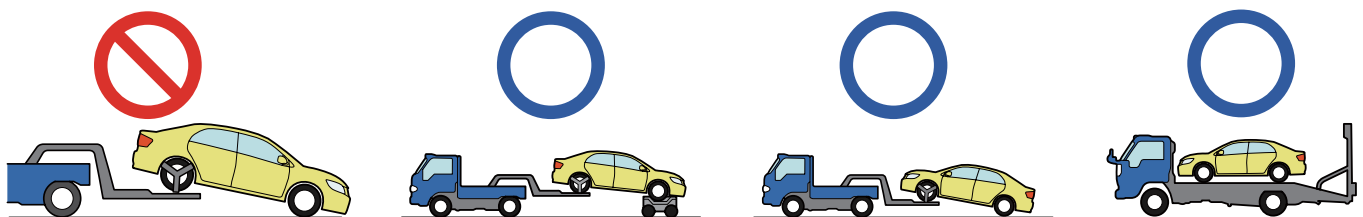

More details, please refer to "Emergency Response Guide".



TOYOTA COROLLA CROSS

2020-06

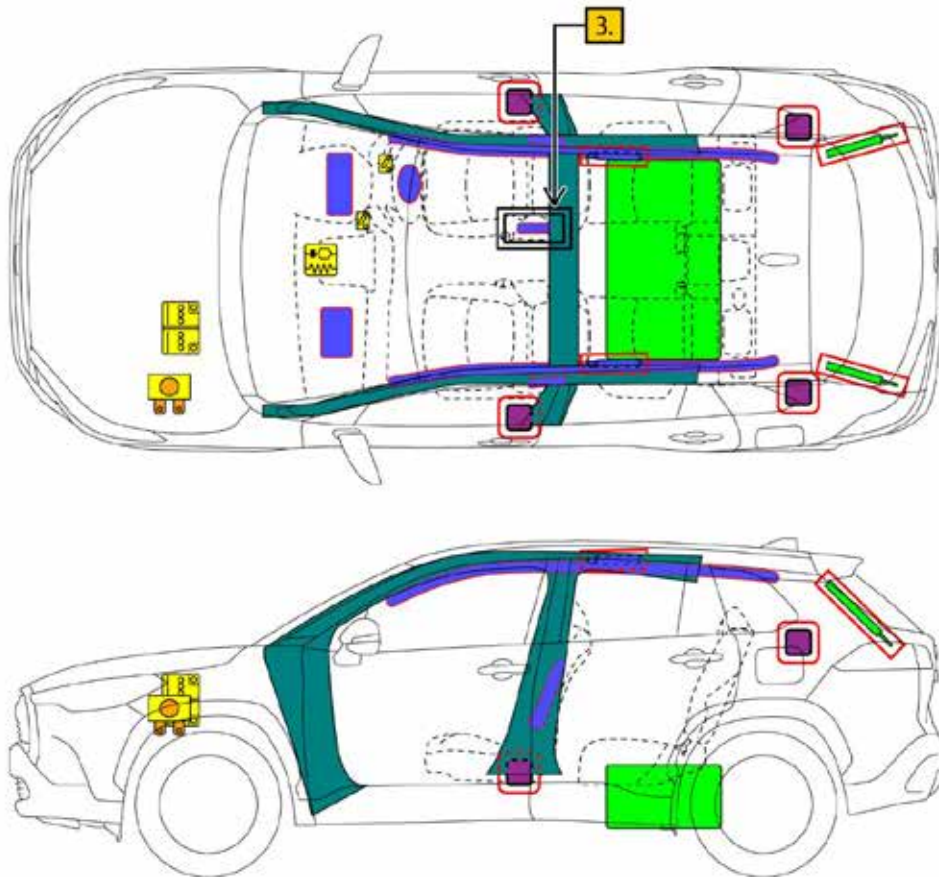

	Airbag		Stored gas inflator		Seat belt pretensioner		SRS control unit		Pedestrian protection active system
	Automatic rollover protection system		Gas strut / Preloaded spring		High strength zone		Zone requiring special attention		
	Battery low voltage		Ultra capacitor, low voltage		Fuel tank		Gas tank		Safety valve
	High voltage battery pack		High voltage power cable / component		High voltage disconnect		Fuse box disabling high voltage system		Ultra capacitor, high voltage
	Low voltage device that disconnects high voltage		Device to shut down power in vehicle						
ID No.			Version No.		Version date		Page		
COROLLACROSS10			04		10 / 2024		1 / 4		

1. Identification / Recognition



Lack of engine noise does not mean vehicle is off. Silent movement or instant restart capability exists until vehicle is fully shut down.

■ Location of vehicle badges

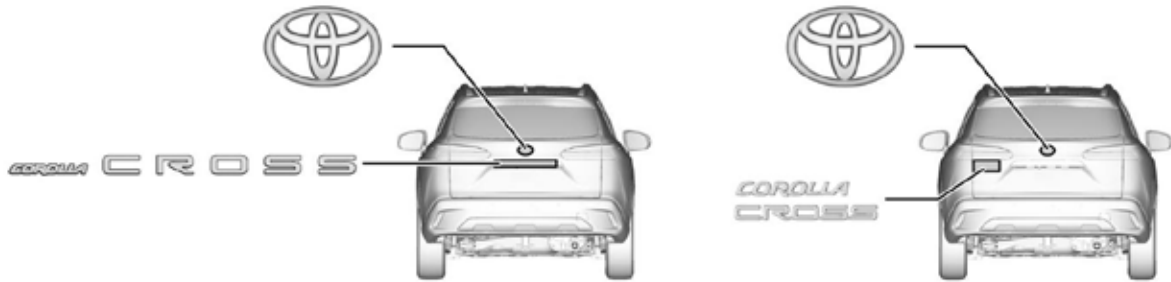

2. Immobilisation / Stabilisation / Lifting

■ Completely immobilize the vehicle

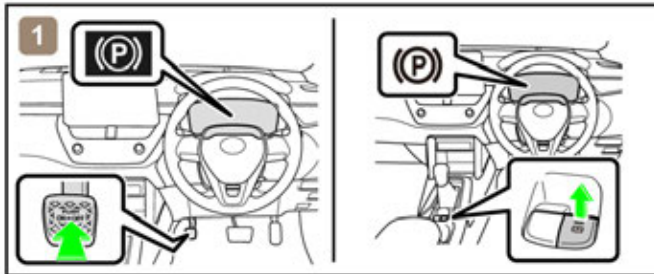

1) Chock the wheels and engage the parking brake.

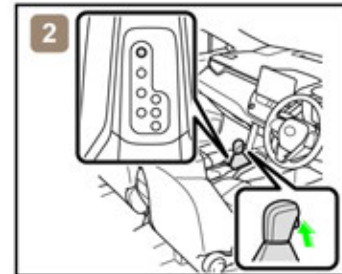

2) Move the shift lever to the park (P) position.

■ Stabilisation-lifting point

Place cribbing such as wooden blocks at the four points under the front and rear pillars.

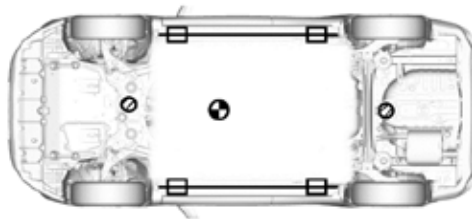

Extra Reinforced Lifting Points



Standard Jack Locations



Vehicle Center of Gravity



Do not place cribbing such as wooden blocks or rescue air lifting bags under the exhaust system or fuel system. Doing so may result in fuel leaks or fire.

ID No.	Version No.	Version date	Page
COROLLACROSS10	04	10 / 2024	2 / 4

3. Disable direct hazards / Safety regulations

- If any of the following systems are required to be operated, operate them **BEFORE** disconnecting the battery.

Power door lock
Power Back door
Electric parking brake

Power window
Moon roof
Panoramic moon roof

Back door opener
Power seat

When the 12 V battery is disconnected, electrical components cannot be operated.

- Perform procedure Main or Alternative to completely shut off the vehicle.

<Main Procedure>

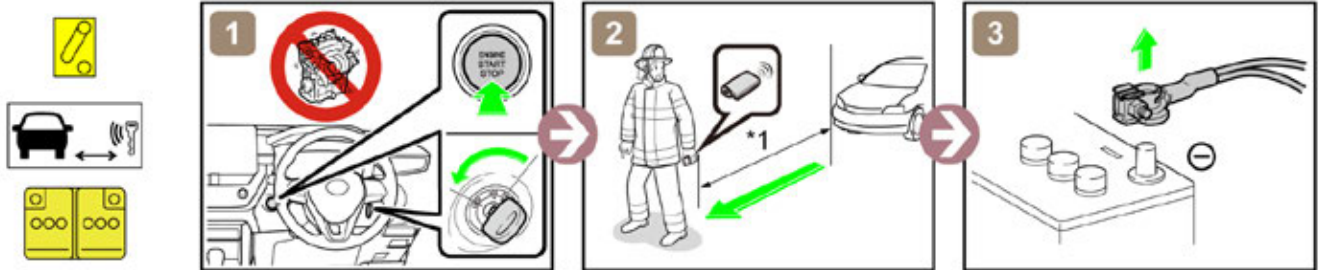

*1: 5 m (16.4 ft) or more

<Alternative Procedure>



*2: IG2-MAIN FUSE (20 A YELLOW)
or
IGP-MAIN FUSE (25 A CLEAR)

- Access to 12 V Battery

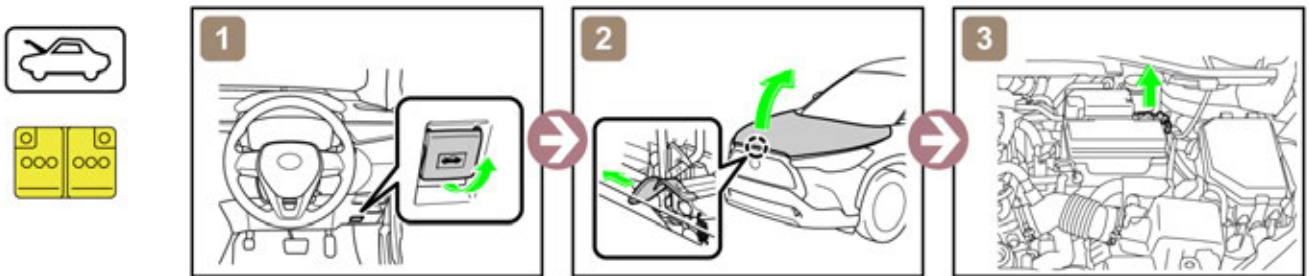

4. Access to the occupants

- Window Glass

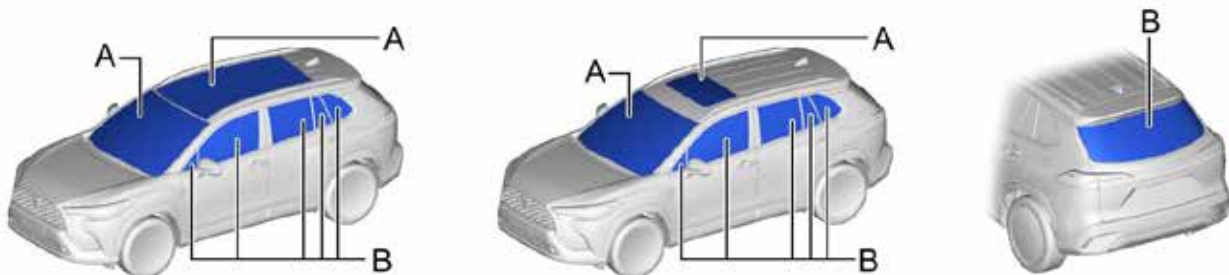

A	Laminated	B	Tempered
---	-----------	---	----------

ID No.	Version No.	Version date	Page
COROLLACROSS10	04	10 / 2024	3 / 4

5. Stored energy / Liquids / Gases / Solids



12 V Battery



Gasoline Tank: 47 L



Always wear appropriate personal protective equipment (PPE) when dealing with any of these items.

6. In case of fire



RE-IGNITION POSSIBLE !



7. In case of submersion



Work on the vehicle only after the vehicle has been pulled out of the water.

8. Towing / Transportation / Storage

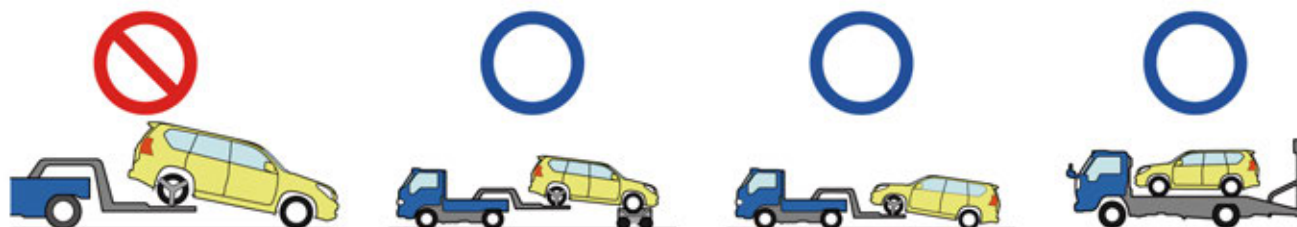

RE-IGNITION POSSIBLE !

Store the vehicle at a safe distance (15 m (49.2 ft) or more) from other vehicles.

9. Important additional information

For further details, please refer to "Emergency Response Guide".

ID No.	Version No.	Version date	Page
COROLLACROSS10	04	10 / 2024	4 / 4



TOYOTA COROLLA CROSS HYBRID
2020-06

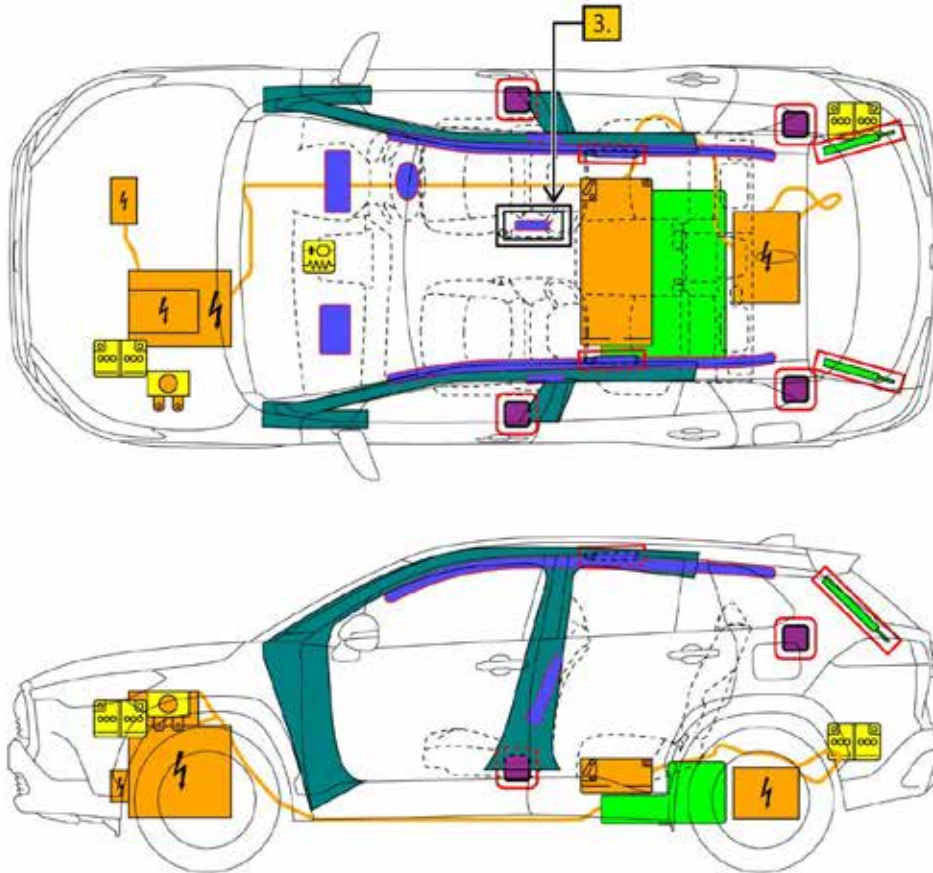

	Airbag		Stored gas inflator		Seat belt pretensioner		SRS control unit		Pedestrian protection active system
	Automatic rollover protection system		Gas strut / Preloaded spring		High strength zone		Zone requiring special attention		
	Battery low voltage		Ultra capacitor, low voltage		Fuel tank		Gas tank		Safety valve
	High voltage battery pack		High voltage power cable / component		High voltage disconnect		Fuse box disabling high voltage system		Ultra capacitor, high voltage
	Low voltage device that disconnects high voltage		High voltage component						
ID No.			Version No.		Version date		Page		
COROLLACROSSHV10			03		10 / 2024		1 / 4		

1. Identification / Recognition



Lack of engine noise does not mean vehicle is off. Silent movement or instant restart capability exists until vehicle is fully shut down.

■ Location of vehicle badges

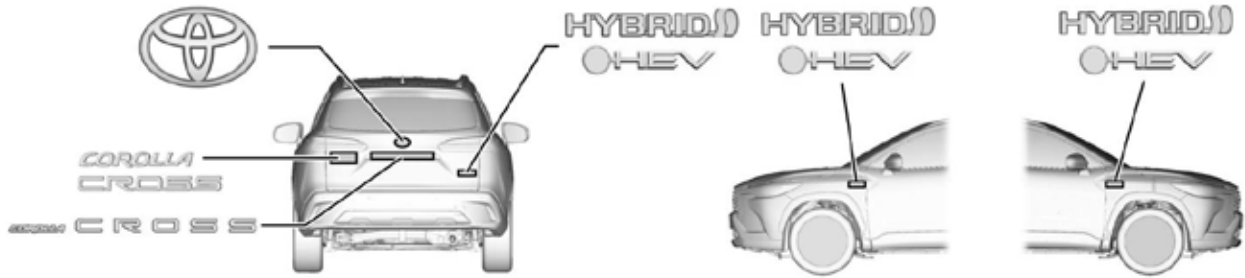

■ Energy source: Lithium-ion battery, Nickel metal hydride battery



2. Immobilisation / Stabilisation / Lifting

■ Completely immobilize the vehicle

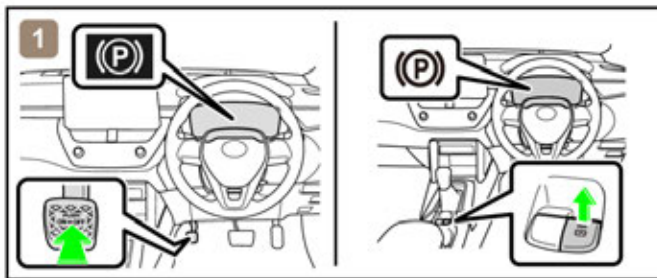

1) Chock the wheels and engage the parking brake.

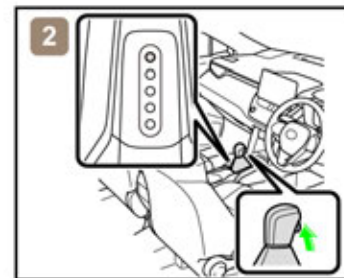

2) Move the shift lever to the park (P) position.

■ Stabilisation-lifting point

Place cribbing such as wooden blocks at the four points under the front and rear pillars.

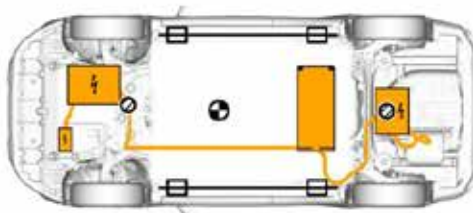

Extra Reinforced Lifting Points



Standard Jack Locations



Vehicle Center of Gravity



Do not place cribbing such as wooden blocks or rescue air lifting bags under the exhaust system, fuel system or high voltage power cables. Doing so may result in fuel leaks, fire, or electric shock.

ID No.	Version No.	Version date	Page
COROLLACROSSHV10	03	10 / 2024	2 / 4

3. Disable direct hazards / Safety regulations

- If any of the following systems are required to be operated, operate them **BEFORE** disconnecting the battery.

Power door lock

Power window

Back door opener

Power Back door

Moon roof

Power seat

Electric parking brake

Panoramic moon roof

When the 12 V battery is disconnected, electrical components cannot be operated.

- Perform procedure Main or Alternative to completely shut off the vehicle.

<Main Procedure>

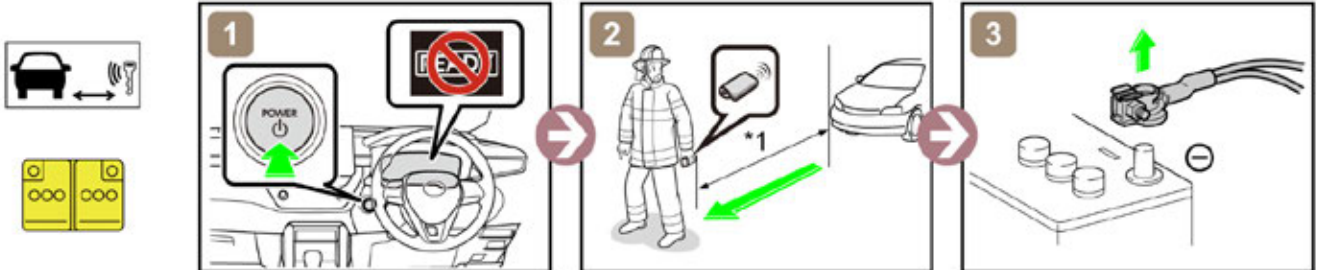

*1: 5 m (16.4 ft) or more

<Alternative Procedure>

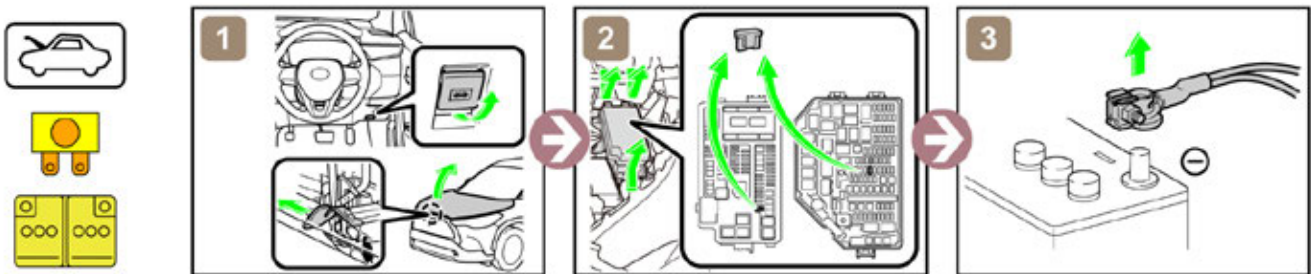

*2: IG2-MAIN FUSE (20 A YELLOW)
or
IGP-MAIN FUSE (25 A CLEAR)

- Access to 12 V Battery

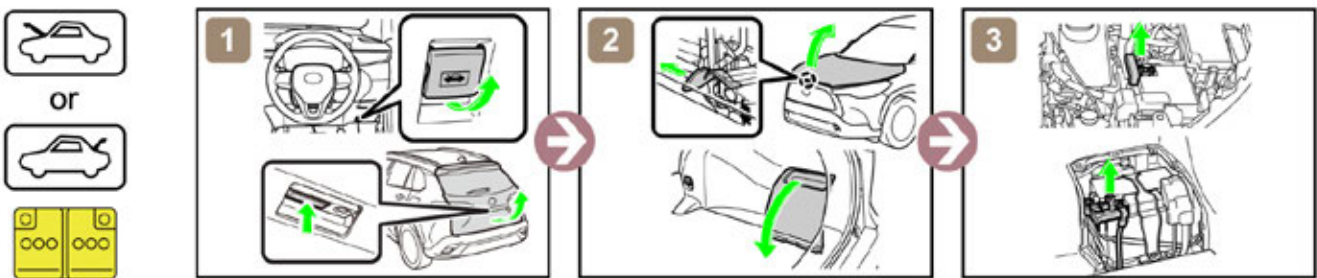

4. Access to the occupants

- Window Glass

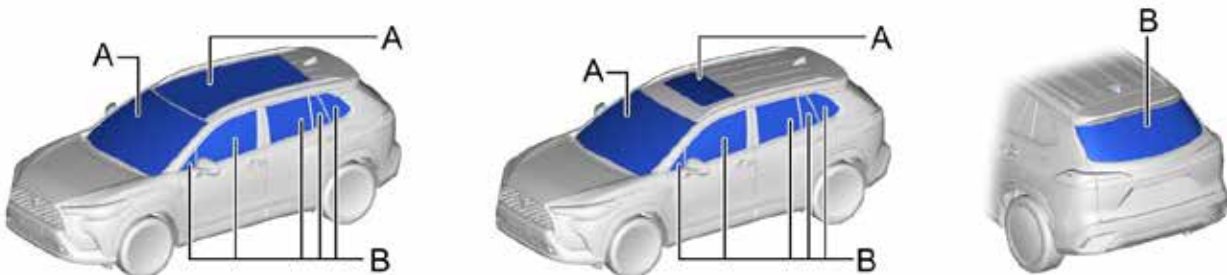

A	Laminated	B	Tempered
---	-----------	---	----------

ID No.	Version No.	Version date	Page
COROLLACROSSHV10	03	10 / 2024	3 / 4

5. Stored energy / Liquids / Gases / Solids



- High Voltage Li-ion Battery
- High Voltage Ni-MH Battery



12 V Battery



Gasoline Tank: 36 L, 43L



- Always wear appropriate personal protective equipment (PPE) when dealing with any of these items.
- Never breach or remove the battery assembly cover under any circumstances, including fire. Doing so may result in serious injury or death from severe burns or electric shock.

6. In case of fire



USE COPIOUS AMOUNTS OF WATER

If it is difficult to apply copious amounts of water to the high voltage battery, it is recommended to allow the high voltage battery to burn itself out.



RE-IGNITION POSSIBLE !



7. In case of submersion



Do not touch any of the high-voltage components or cables, including the service plug, while the vehicle is submerged. Doing so may result in electric shock.
Work on the vehicle only after the vehicle has been pulled out of the water.

8. Towing / Transportation / Storage



RE-IGNITION POSSIBLE !

Store the vehicle at a safe distance (15 m (49.2 ft) or more) from other vehicles.

9. Important additional information

For further details, please refer to "Emergency Response Guide".

ID No.	Version No.	Version date	Page
COROLLACROSSHV10	03	10 / 2024	4 / 4



TOYOTA GR COROLLA
2022-09

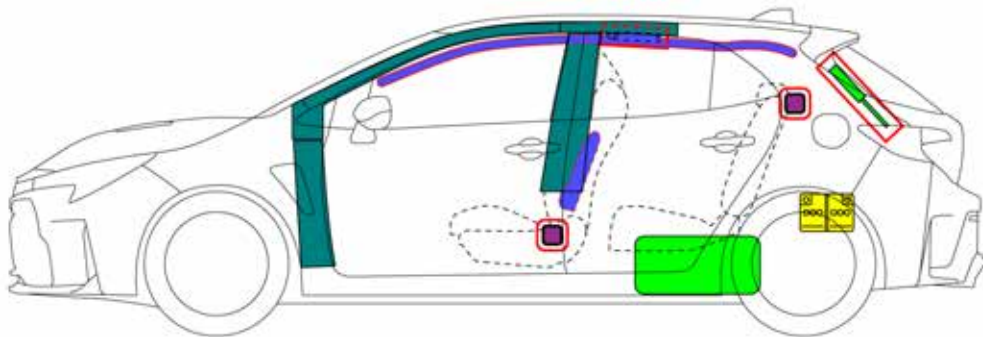
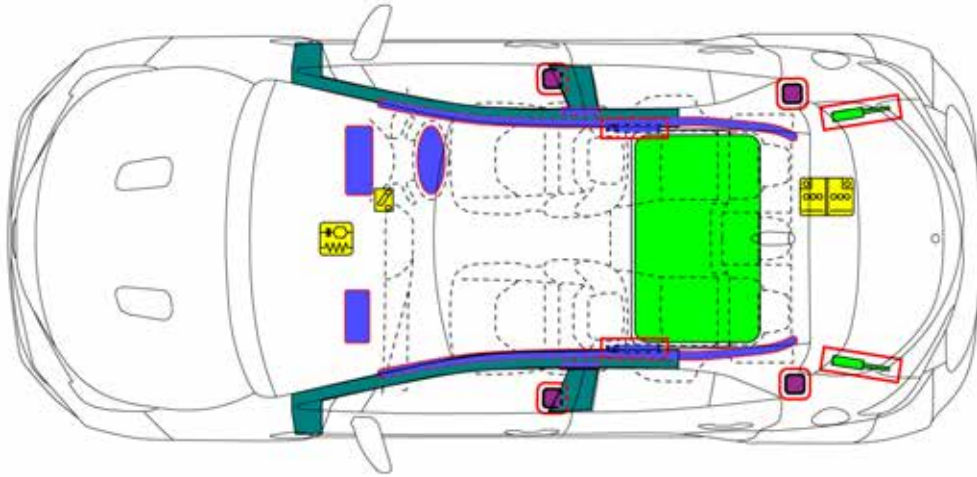
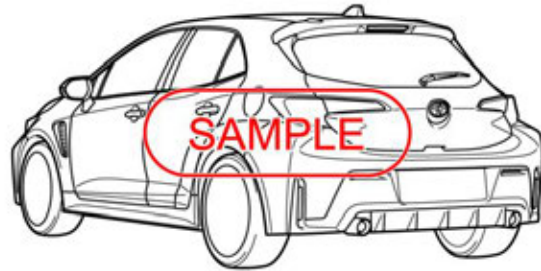
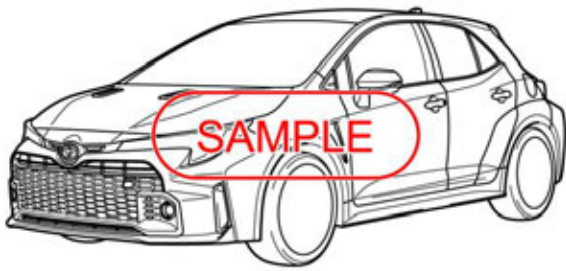

	Airbag		Stored gas inflator		Seat belt pretensioner		SRS control unit		Pedestrian protection active system
	Automatic rollover protection system		Gas strut / Preloaded spring		High strength zone		Zone requiring special attention		
	Battery low voltage		Ultra capacitor, low voltage		Fuel tank		Gas tank		Safety valve
	High voltage battery pack		High voltage power cable / component		High voltage disconnect		Fuse box disabling high voltage system		Ultra capacitor, high voltage
	Low voltage device that disconnects high voltage		Device to shut down power in vehicle						
	ID No.	Version No.		Version date		Page			
	GRCOROLLA14	02		09 / 2024		1 / 4			

1. Identification / Recognition

■ Location of vehicle badges



2. Immobilisation / Stabilisation / Lifting

■ Completely immobilize the vehicle

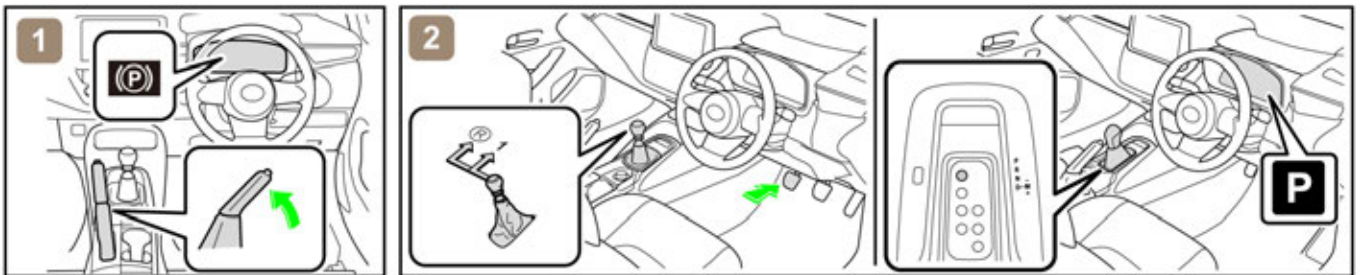

1) Chock the wheels and engage the parking brake.

2) Depress the clutch pedal and move the shift lever to the 1st or reverse (R) position.

2) Move the shift lever to the park (P) position.

■ Stabilisation-lifting point

Place cribbing such as wooden blocks at the four points under the front and rear pillars.



Extra Reinforced Lifting Points



Standard Jack Locations



Vehicle Center of Gravity



Do not place cribbing such as wooden blocks or rescue air lifting bags under the exhaust system or fuel system. Doing so may result in fuel leaks or fire.

ID No.	Version No.	Version date	Page
GRCOROLLA14	02	09 / 2024	2 / 4

3. Disable direct hazards / Safety regulations

- If any of the following systems are required to be operated, operate them **BEFORE** disconnecting the battery.

Power door lock

Power window

Back door opener

When the 12 V battery is disconnected, electrical components cannot be operated.

- Perform procedure Main or Alternative to completely shut off the vehicle.

<Main Procedure>

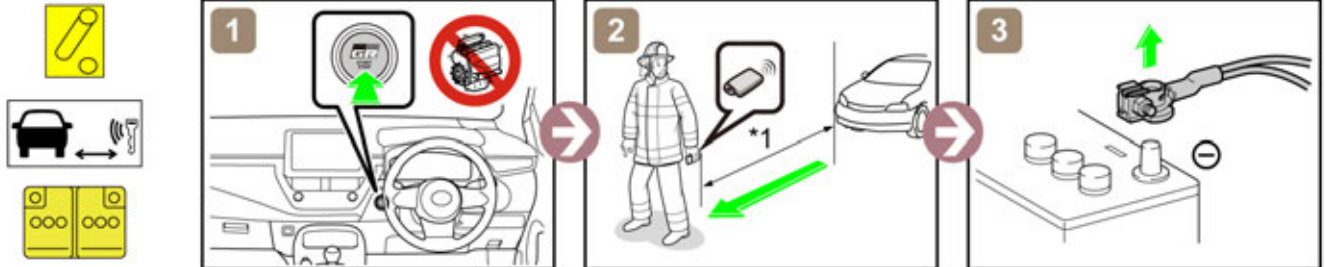

*1: 5 m (16.4 ft) or more

<Alternative Procedure>

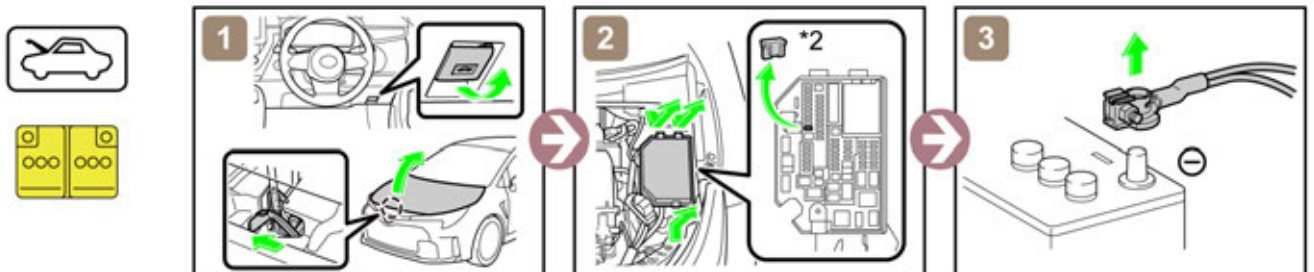

*2: IGP-MAIN FUSE (30 A GREEN)

- Access to 12 V Battery

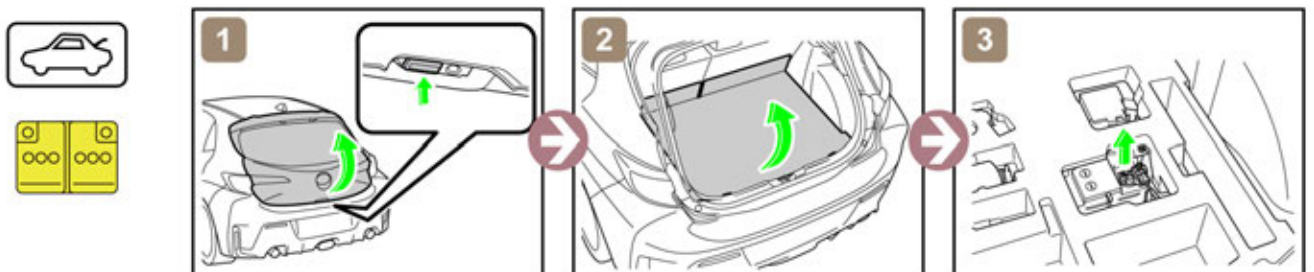

4. Access to the occupants

- Window Glass

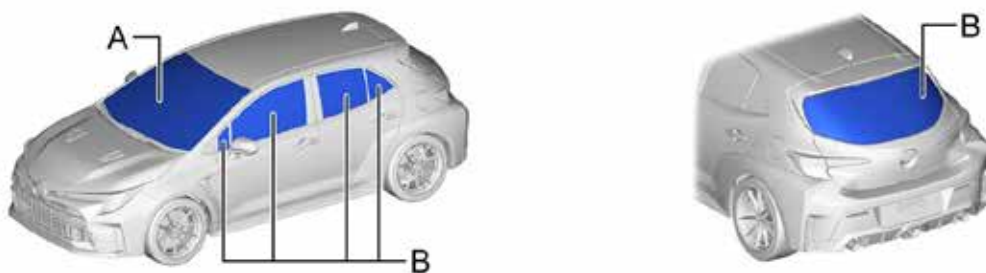

A	Laminated	B	Tempered
---	-----------	---	----------

	ID No.	Version No.	Version date	Page
	GRCOROLLA14	02	09 / 2024	3 / 4

5. Stored energy / Liquids / Gases / Solids



12 V Battery



Gasoline Tank: 50 L



Always wear appropriate personal protective equipment (PPE) when dealing with any of these items.

6. In case of fire



RE-IGNITION POSSIBLE !



7. In case of submersion



Work on the vehicle only after the vehicle has been pulled out of the water.

8. Towing / Transportation / Storage

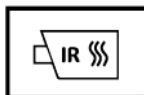
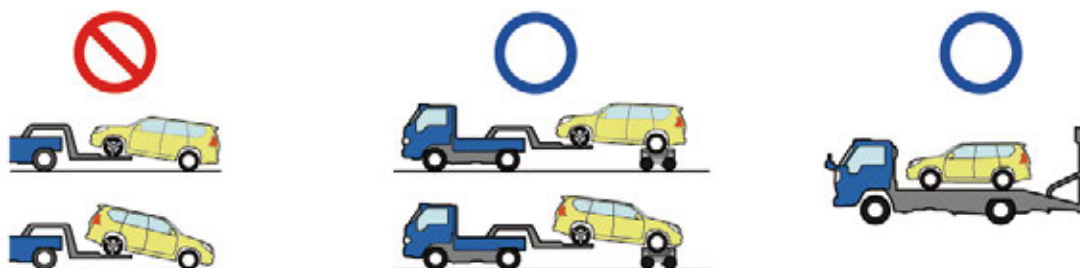

RE-IGNITION POSSIBLE !

Store the vehicle at a safe distance (15 m (49.2 ft) or more) from other vehicles.

9. Important additional information

For further details, please refer to "Emergency Response Guide".

ID No.	Version No.	Version date	Page
GRCOROLLA14	02	09 / 2024	4 / 4

C-HR

RHD

2016-10

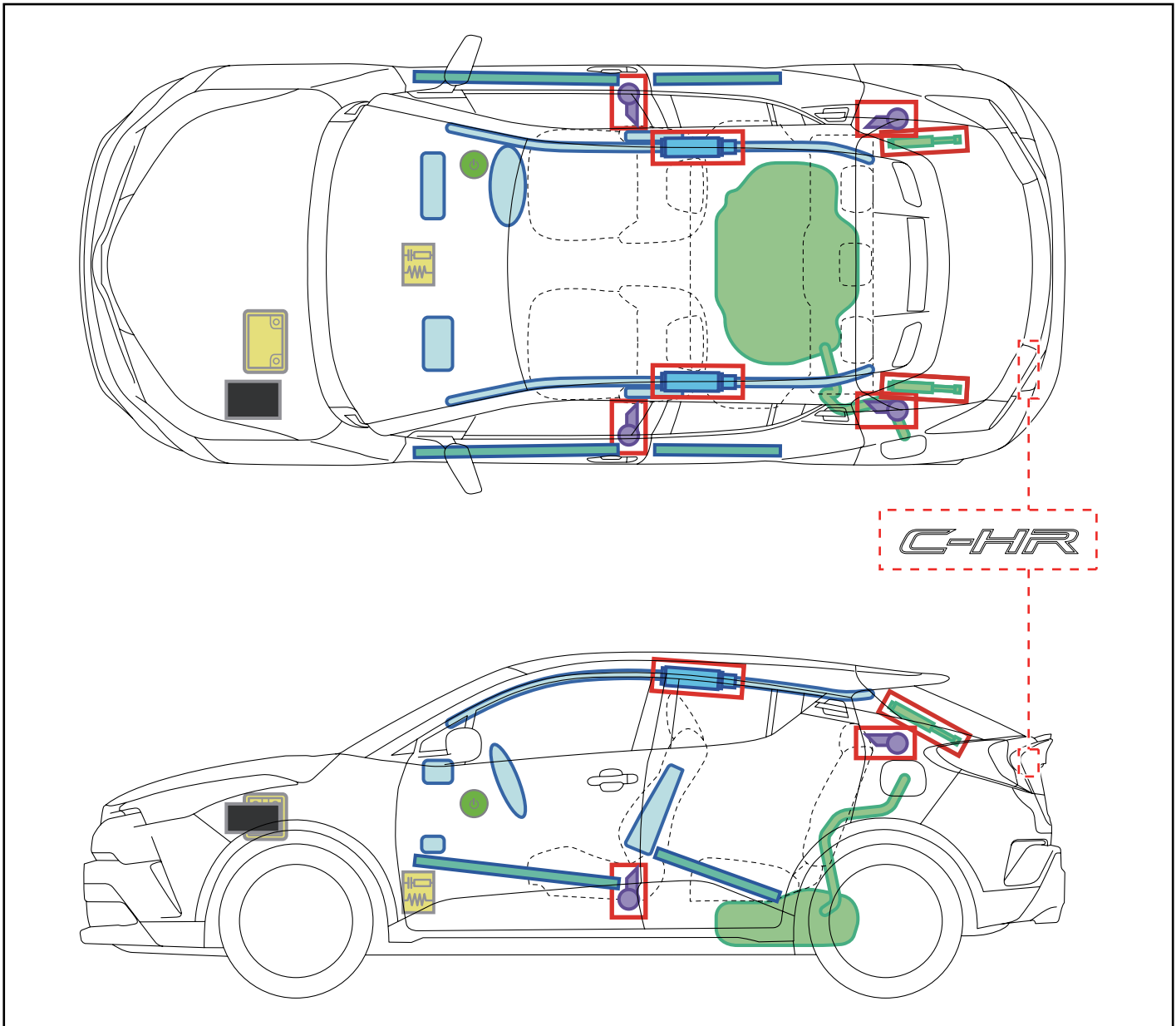
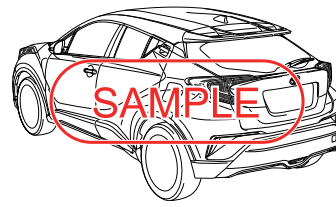
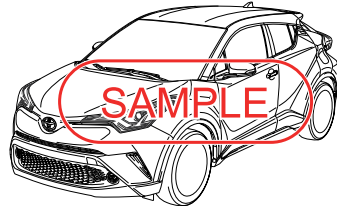

	IG/POWER SW		Fuse Box		12V Battery
	Airbag (incl. Inflator)		Inflator		Fuel Tank
	Gas-filled Damper		Seat Belt Pretensioner (Gas Generator)		Structural Reinforcements
	Airbag Computer	-	-	-	-
-	-	-	-	-	-

Disable Vehicle

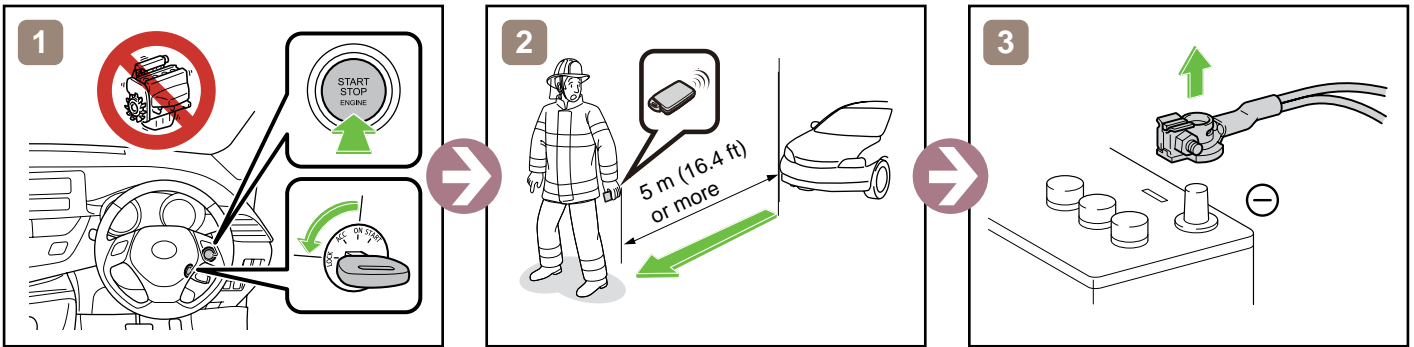

or

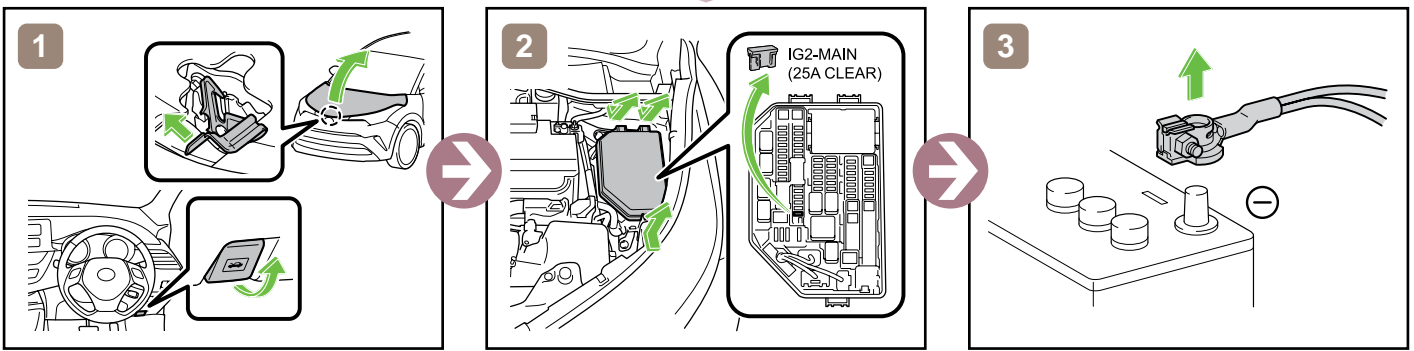

Access to 12V Battery

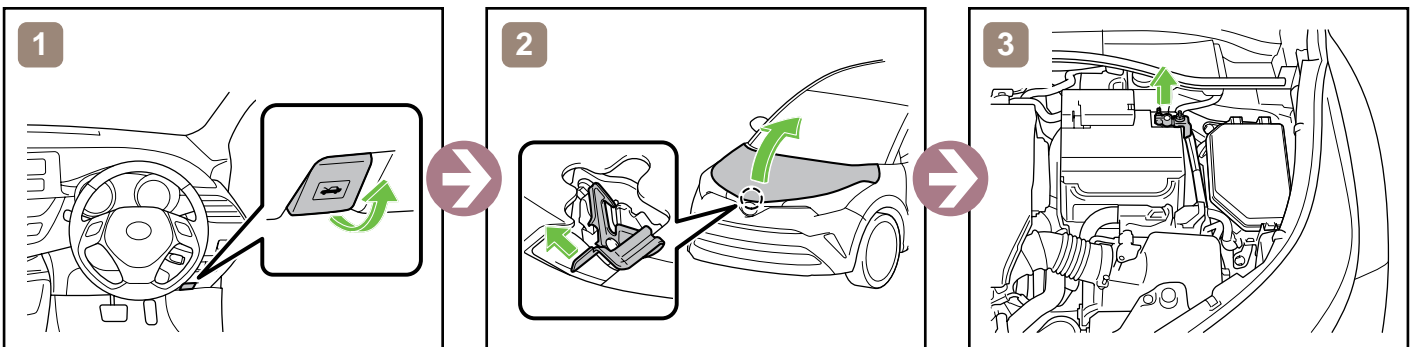

Towing Information

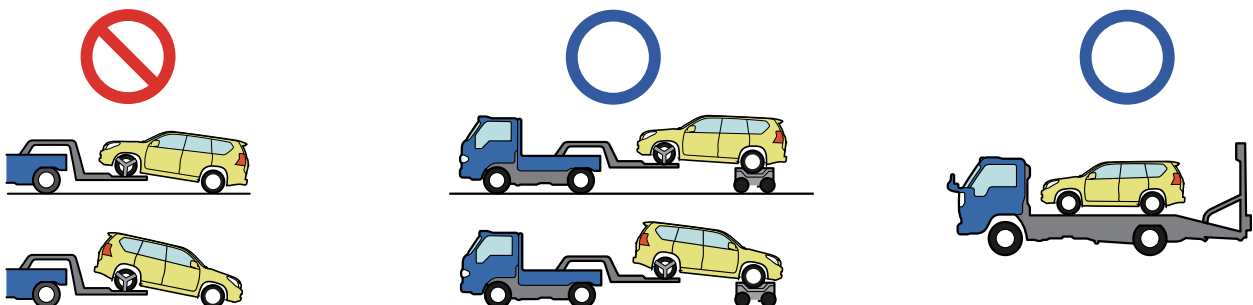









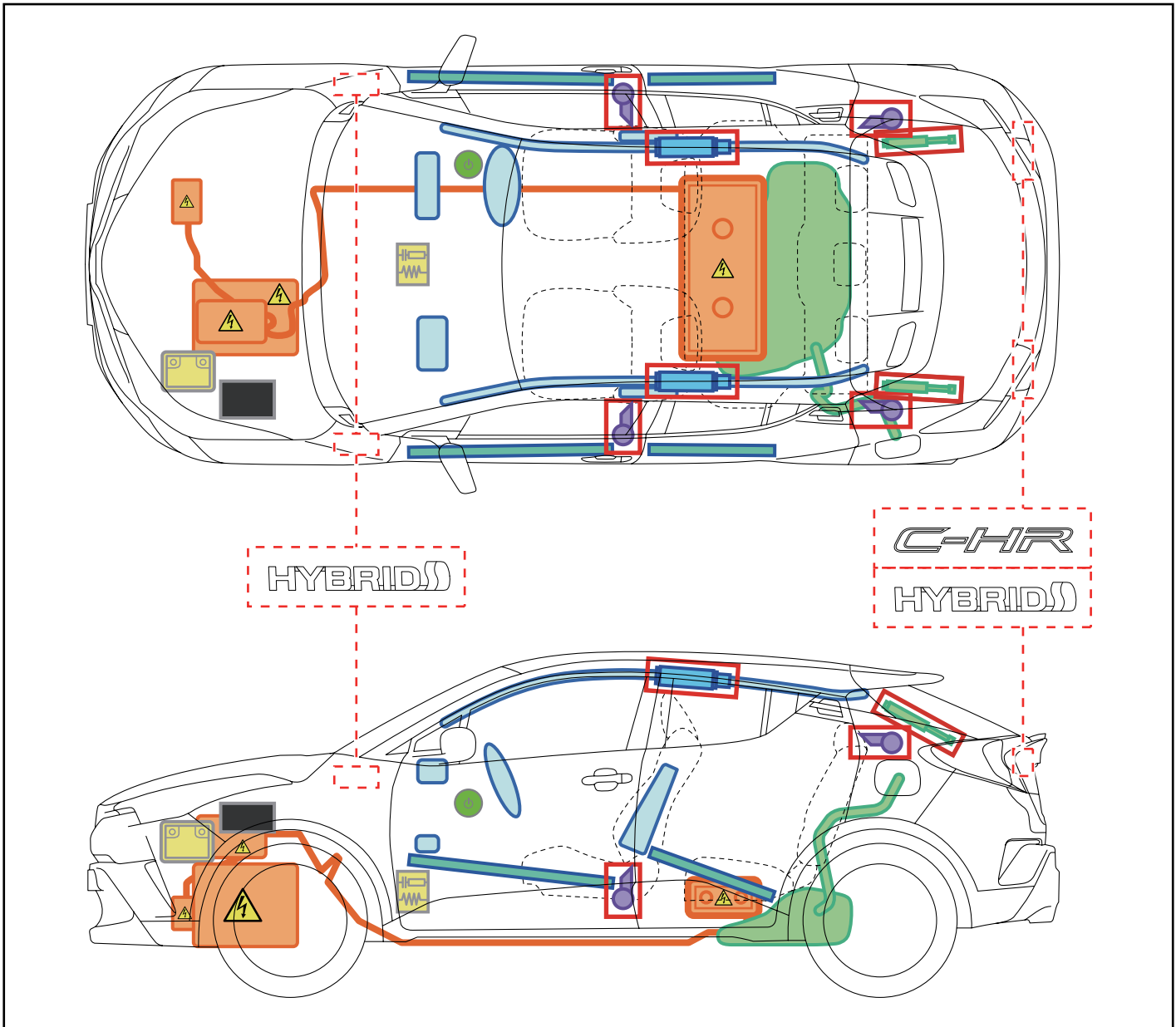
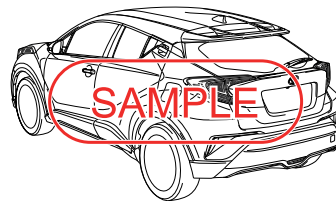
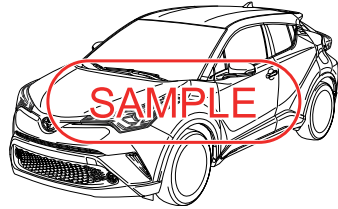



More details, please refer to "Emergency Response Guide".

C-HR HYBRID

RHD

2016-10



	IG/POWER SW		Fuse Box		12V Battery
	Airbag (incl. Inflator)		Inflator		High Voltage Battery
	High Voltage Components		Fuel Tank		Gas-filled Damper
	Seat Belt Pretensioner (Gas Generator)		Structural Reinforcements		Airbag Computer
-	-	-	-	-	-

Disable Vehicle

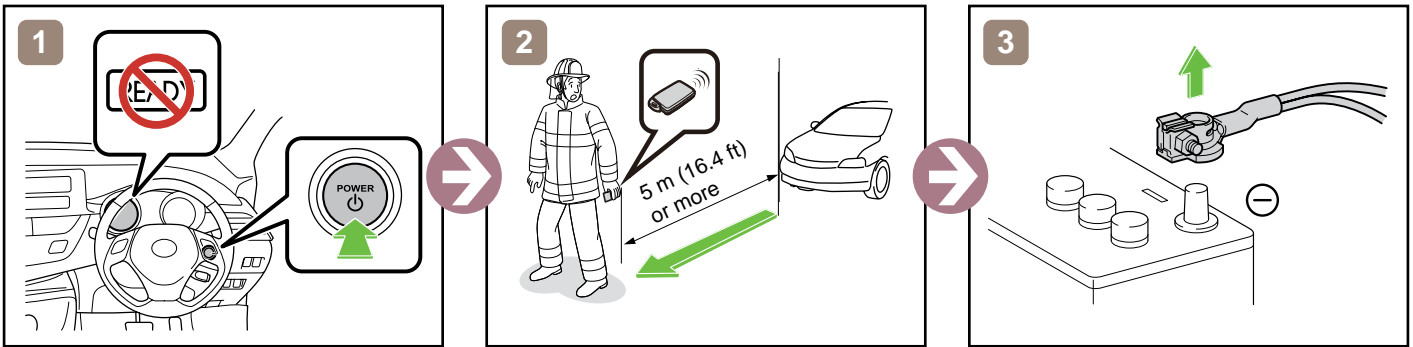

or

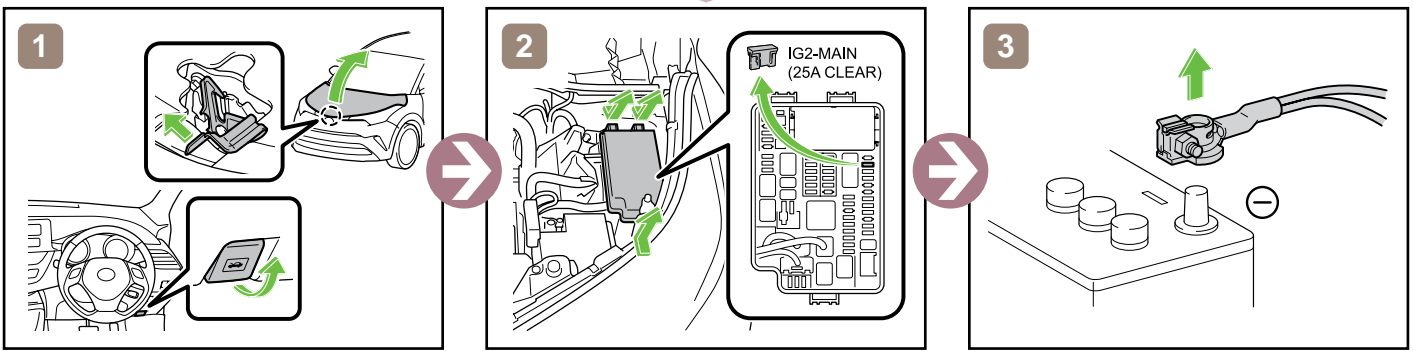

Access to 12V Battery

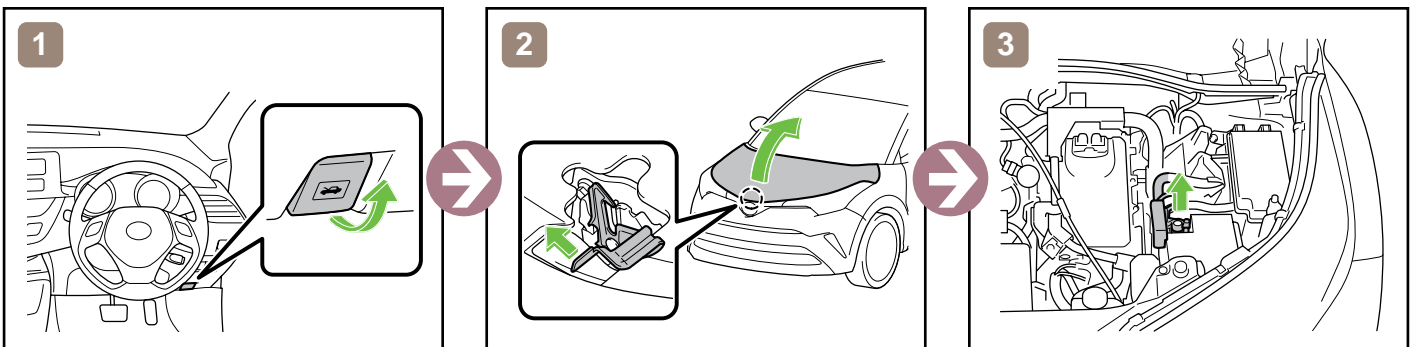

Towing Information

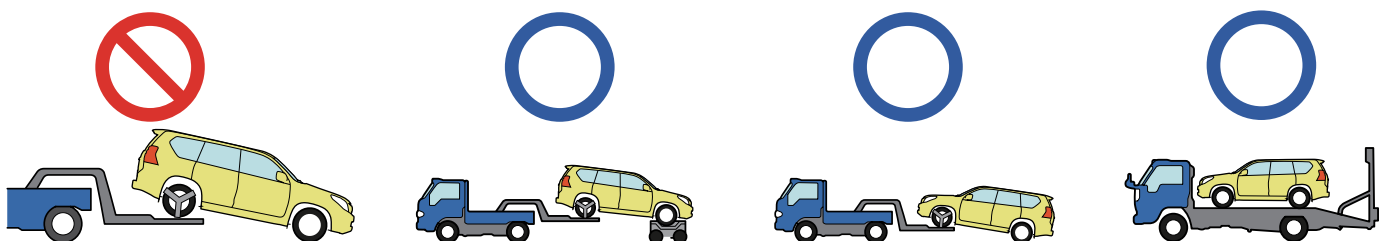

More details, please refer to "Emergency Response Guide".

1. Identification / Recognition



Lack of engine noise does not mean vehicle is off. Silent movement or instant restart capability exists until vehicle is fully shut down.

■ Location of vehicle badges



■ Energy source: Lithium-ion battery



2. Immobilisation / Stabilisation / Lifting

■ Completely immobilize the vehicle

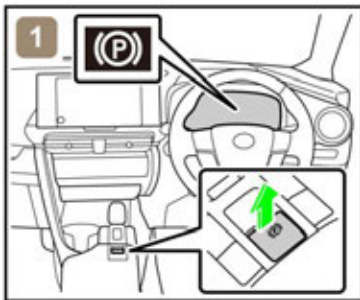

1) Chock the wheels and engage the parking brake.

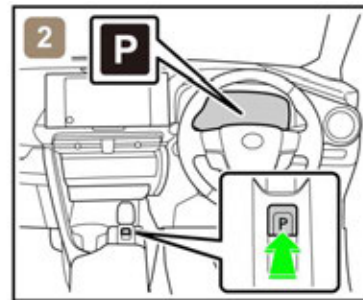

2) Press the P position switch.

■ Stabilisation-lifting point

Place cribbing such as wooden blocks at the four points under the front and rear pillars.

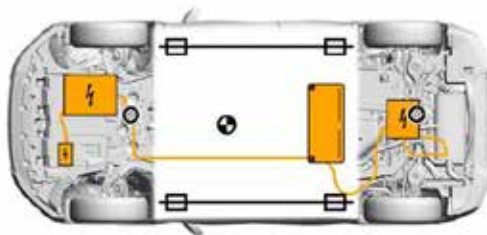

Extra Reinforced Lifting Points



Standard Jack Locations



Vehicle Center of Gravity



Do not place cribbing such as wooden blocks or rescue air lifting bags under the exhaust system, fuel system or high voltage power cables. Doing so may result in fuel leaks, fire, or electric shock.

ID No.	Version No.	Version date	Page
C-HR HV20	01	10 / 2023	2 / 4

3. Disable direct hazards / Safety regulations

If any of the following systems are required to be operated, operate them **BEFORE** disconnecting the battery.

Power door lock
Power seat

Power window
Electric parking brake

Power Back door
Electronic shift lever

When the 12 V battery is disconnected, electrical components cannot be operated.

■ Perform procedure Main or Alternative to completely shut off the vehicle.

<Main Procedure>

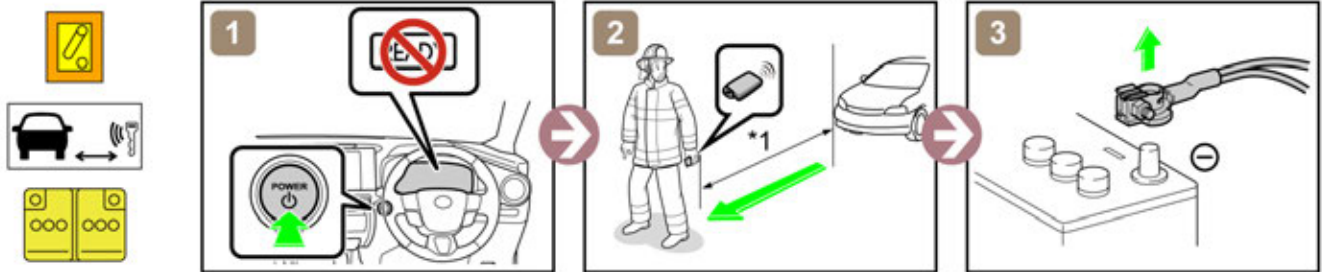

*1: 5 m (16.4 ft) or more

<Alternative Procedure>

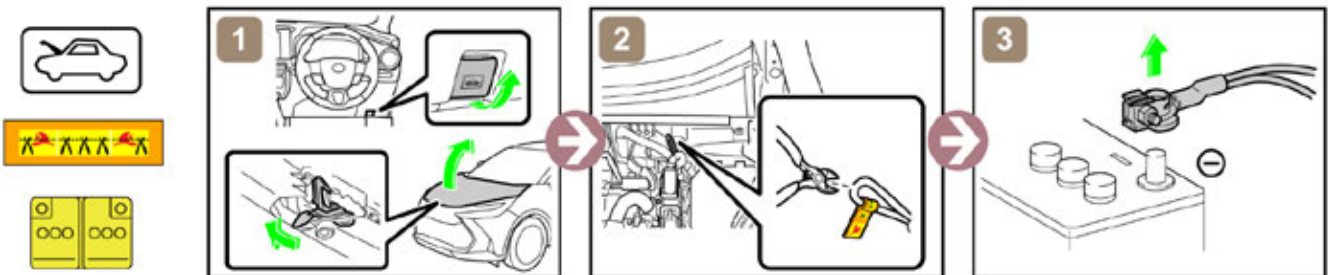

In the event of an accident in which the airbags are deployed, the high-voltage system will be automatically deactivated.

Access to 12 V Battery

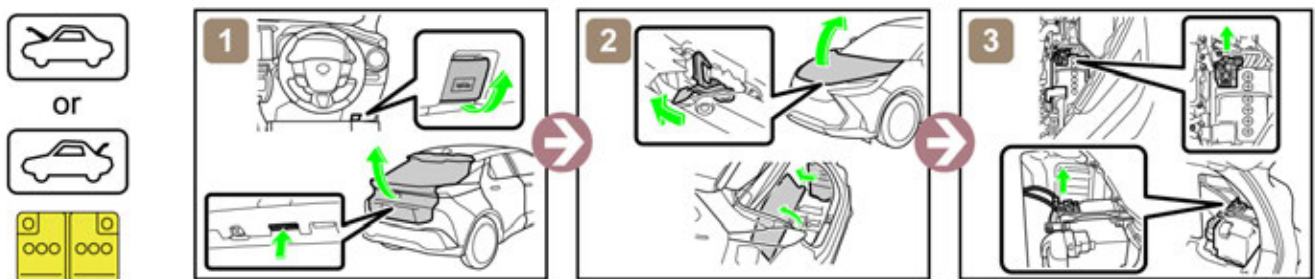

4. Access to the occupants

Window Glass

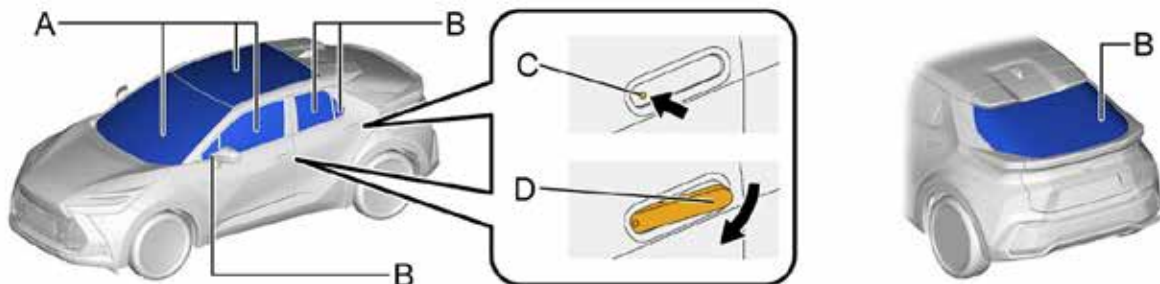

A	Laminated	B	Tempered
C	Flush Handle Movement (Depression on Front End Pressed)	D	Flush Handle Movement (Extend Operation)

ID No.	Version No.	Version date	Page
C-HRV20	01	10 / 2023	3 / 4

5. Stored energy / Liquids / Gases / Solids



High Voltage Li-ion Battery



12 V Battery



Gasoline Tank: 43 L



- Always wear appropriate personal protective equipment (PPE) when dealing with any of these items.
- Never breach or remove the battery assembly cover under any circumstances, including fire. Doing so may result in serious injury or death from severe burns or electric shock.

6. In case of fire



USE COPIOUS AMOUNTS OF WATER

If it is difficult to apply copious amounts of water to the high voltage battery, it is recommended to allow the high voltage battery to burn itself out.



RE-IGNITION POSSIBLE !



7. In case of submersion



Do not touch any of the high-voltage components or cables, including the service plug, while the vehicle is submerged. Doing so may result in electric shock.
Work on the vehicle only after the vehicle has been pulled out of the water.

8. Towing / Transportation / Storage

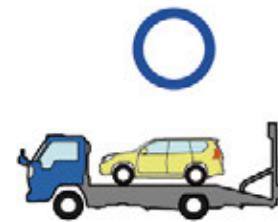
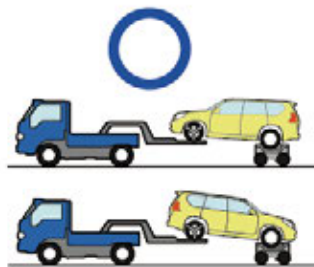
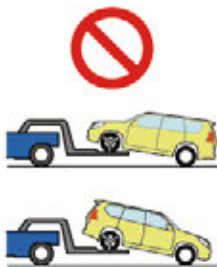

RE-IGNITION POSSIBLE !

Store the vehicle at a safe distance (15 m (49.2 ft) or more) from other vehicles.

9. Important additional information

For further details, please refer to "Emergency Response Guide".

ID No.	Version No.	Version date	Page
C-HRHV20	01	10 / 2023	4 / 4

FORTUNER

RHD

2015-7

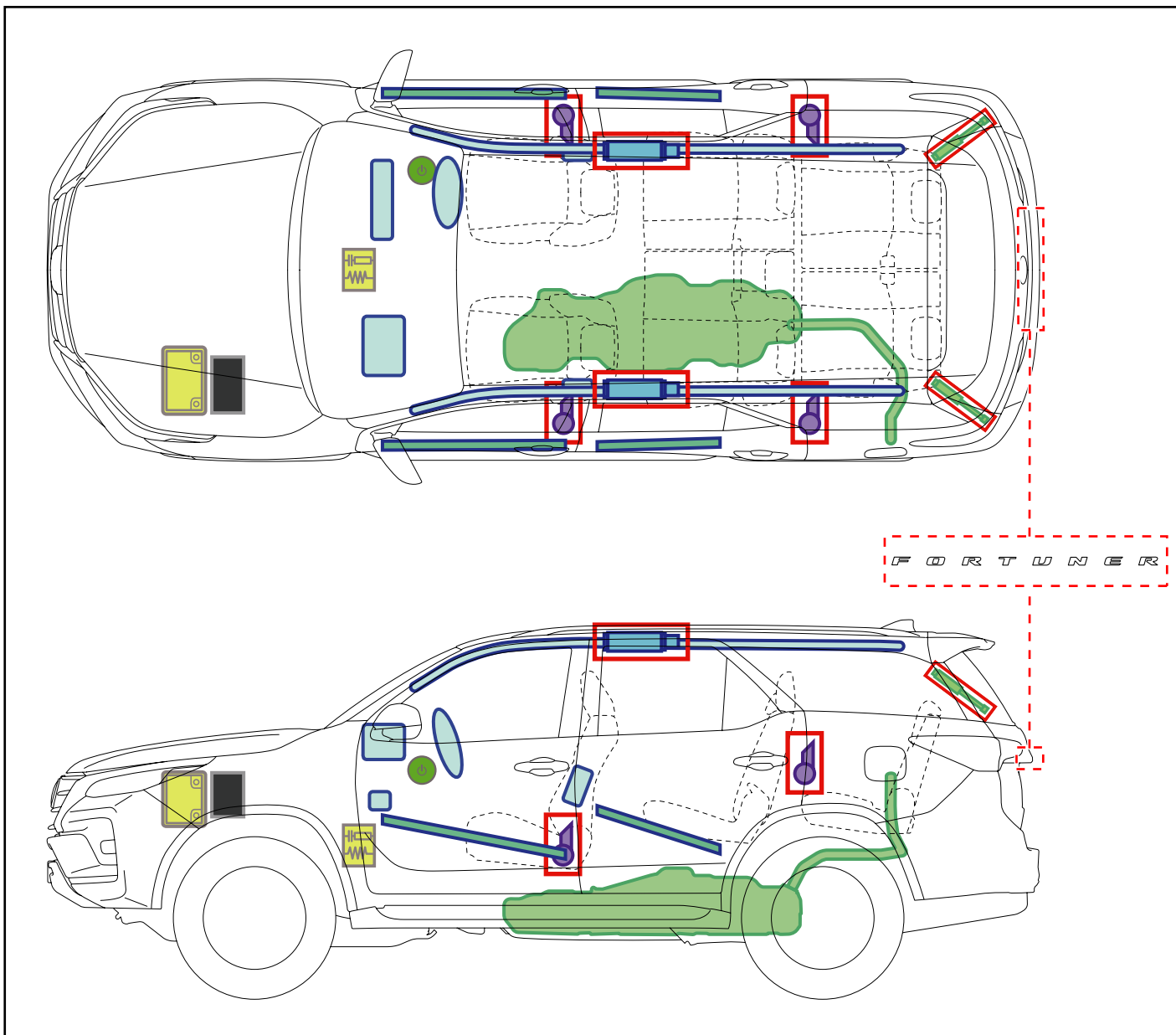
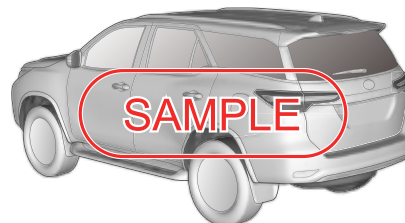
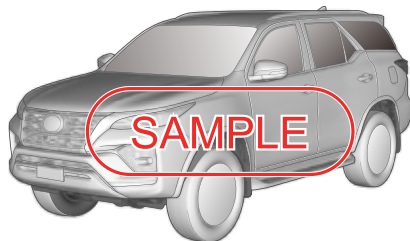

	IG/POWER SW		Fuse Box		12V Battery
	Airbag (incl. Inflator)		Inflator		Fuel Tank
	Gas-filled Damper		Seat Belt Pretensioner (Gas Generator)		Structural Reinforcements
	Airbag Computer	—	—	—	—
—	—	—	—	—	—

Disable Vehicle

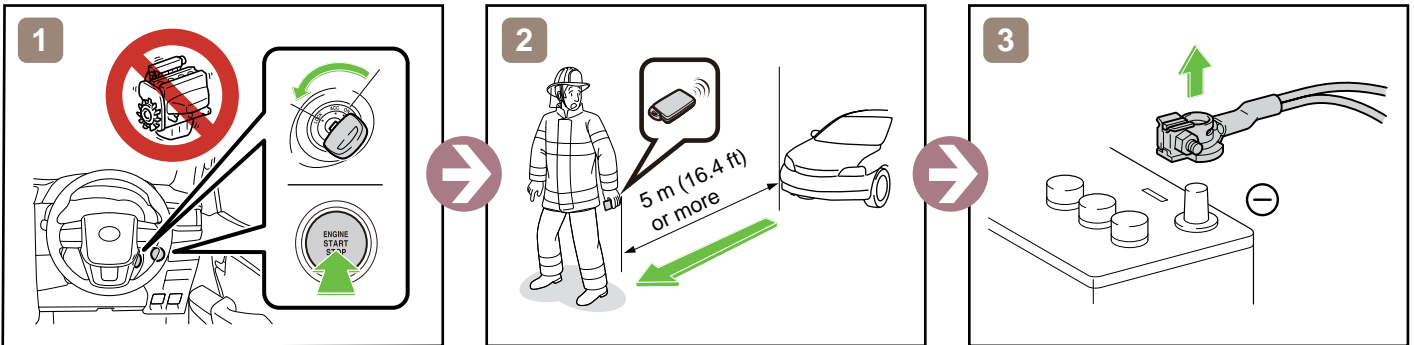

or

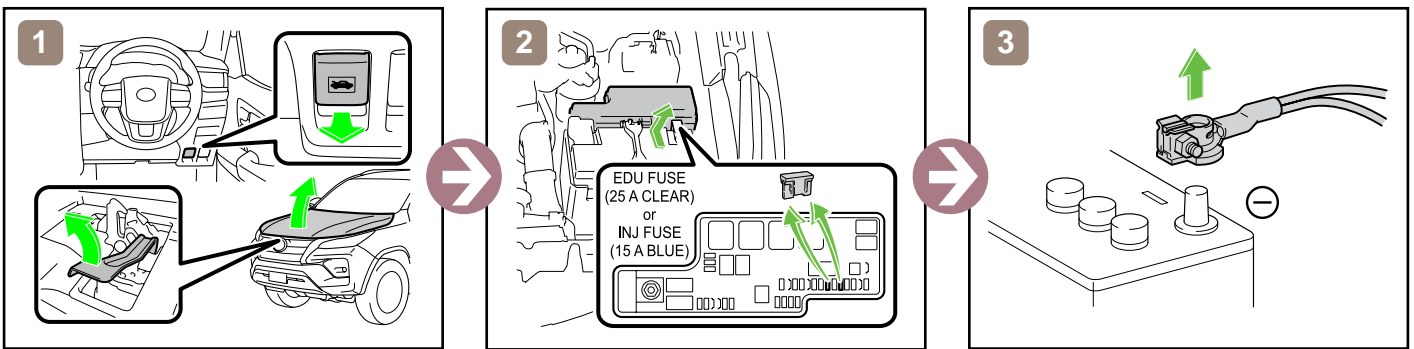

Access to 12V Battery

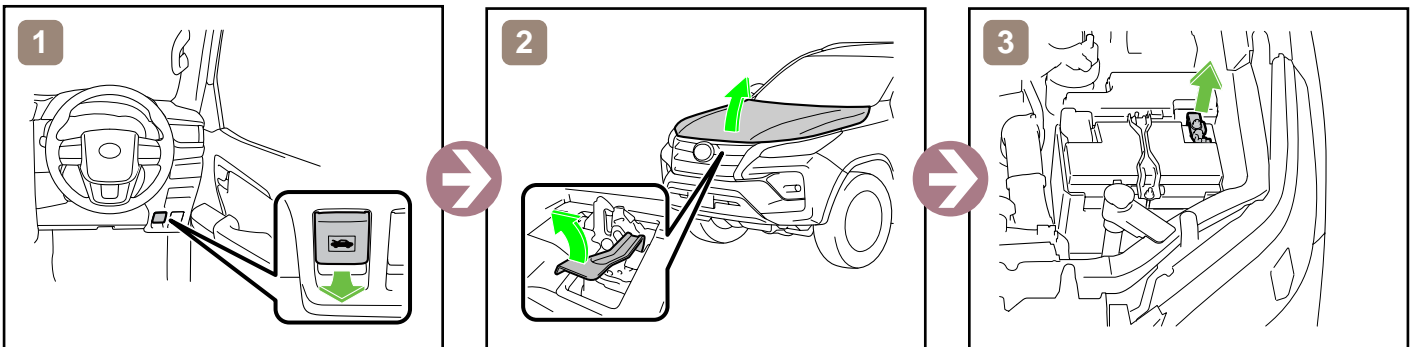

Towing Information

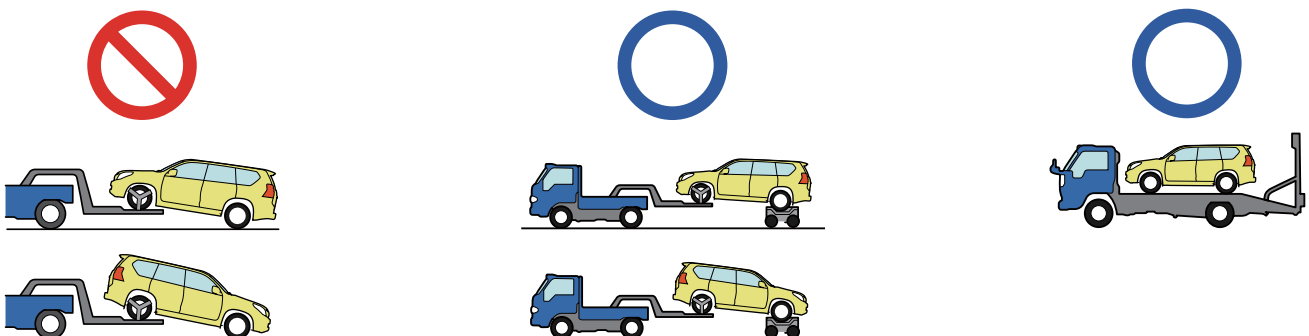

More details, please refer to "Emergency Response Guide".

HIACE

LONG

2013-12

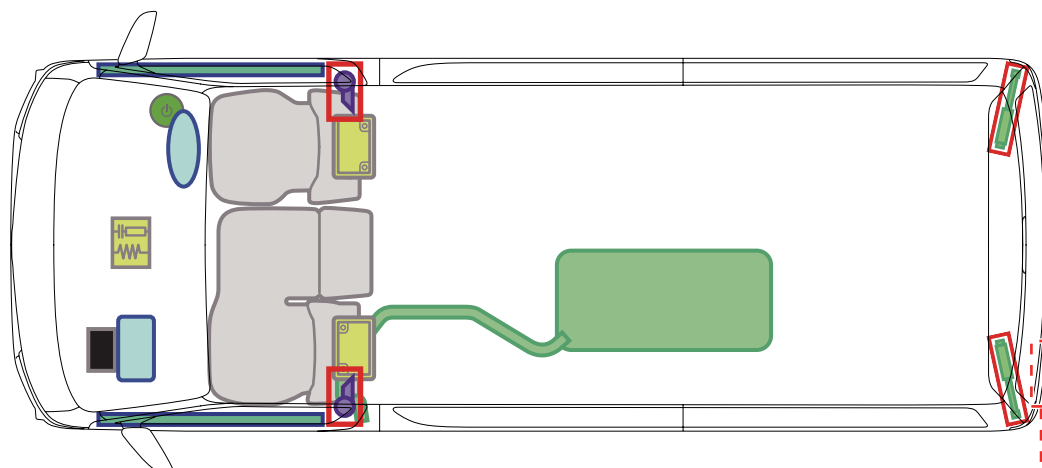

HIACE

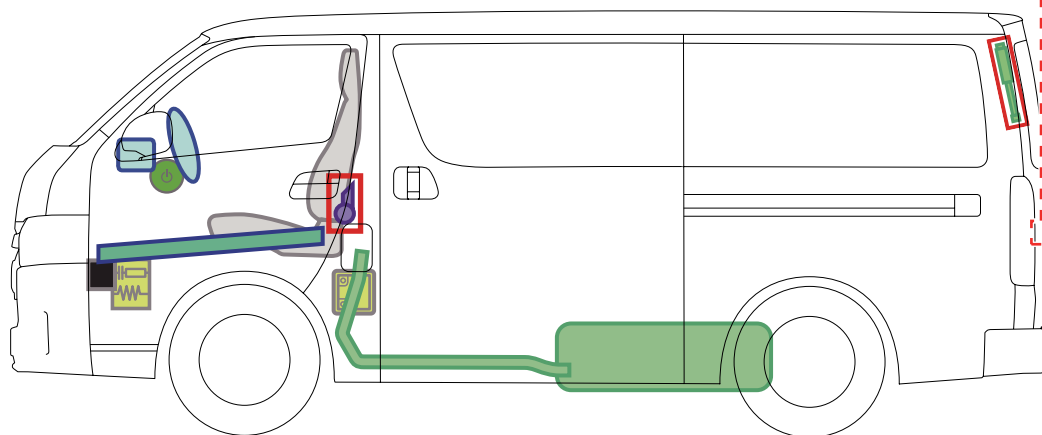

	IG/ENGINE SW		Fuse Box		12V Battery
	Airbag (incl. Inflator)		Fuel Tank		Gas-filled Damper
	Seat Belt Pretensioner (Gas Generator)		Structural Reinforcements		Airbag Computer
—	—	—	—	—	—
—	—	—	—	—	—

Disable Vehicle

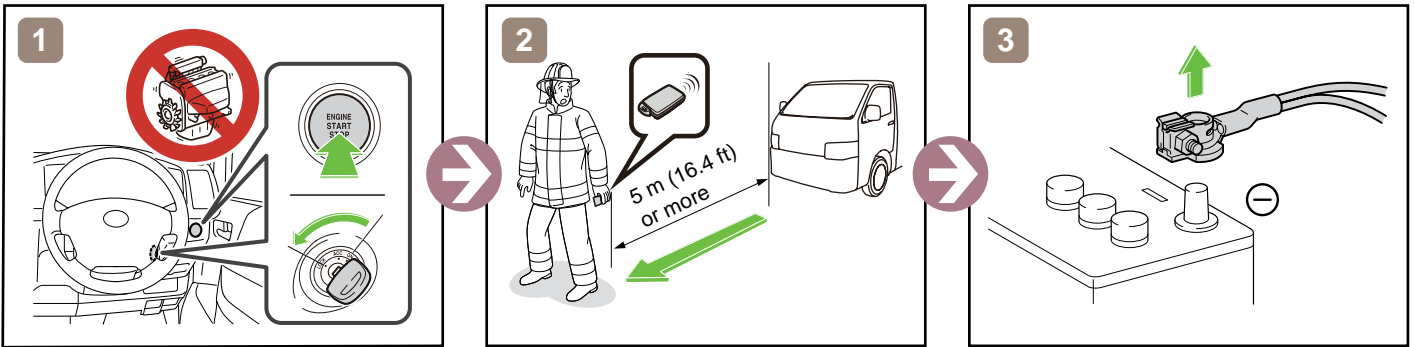

or

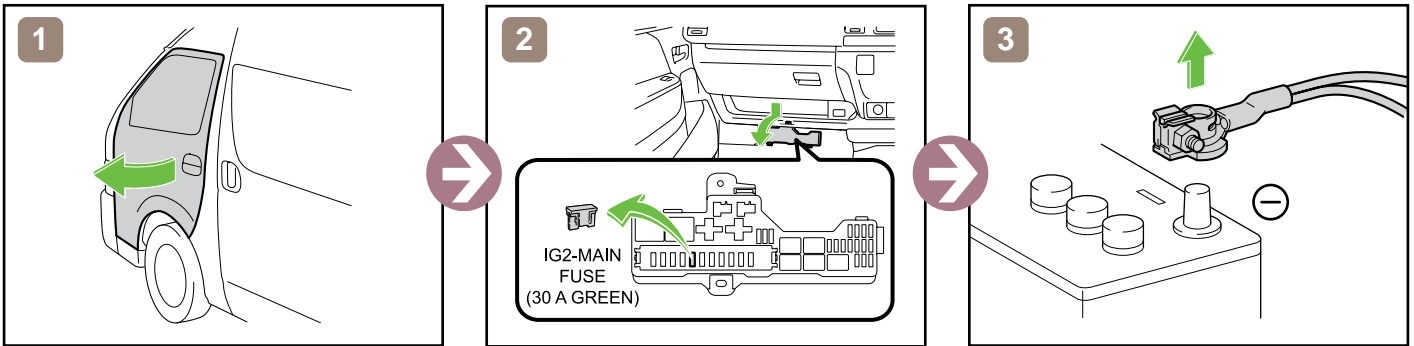

Access to 12V Battery

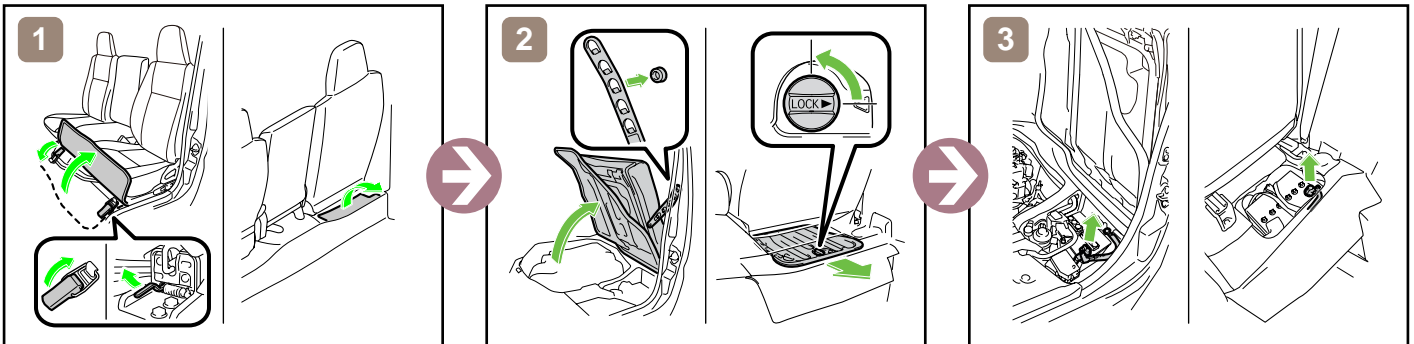

Towing Information

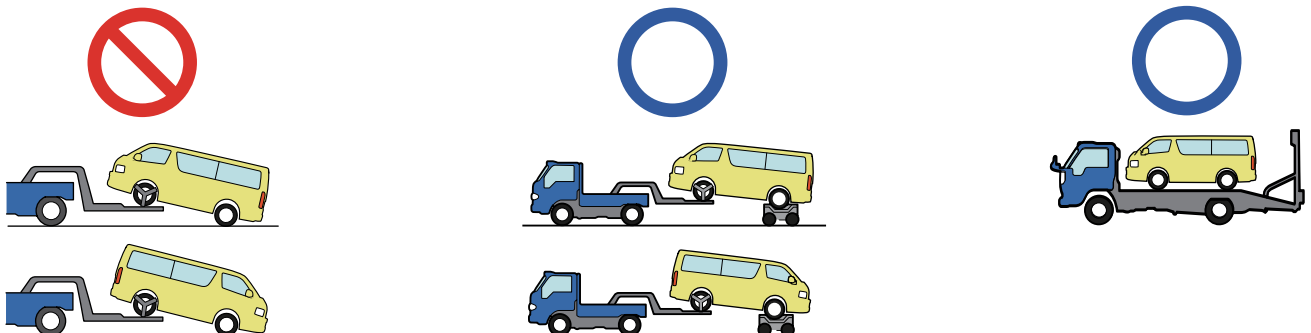

More details, please refer to "Emergency Response Guide".

HIACE
SUPER LONG
2013-12

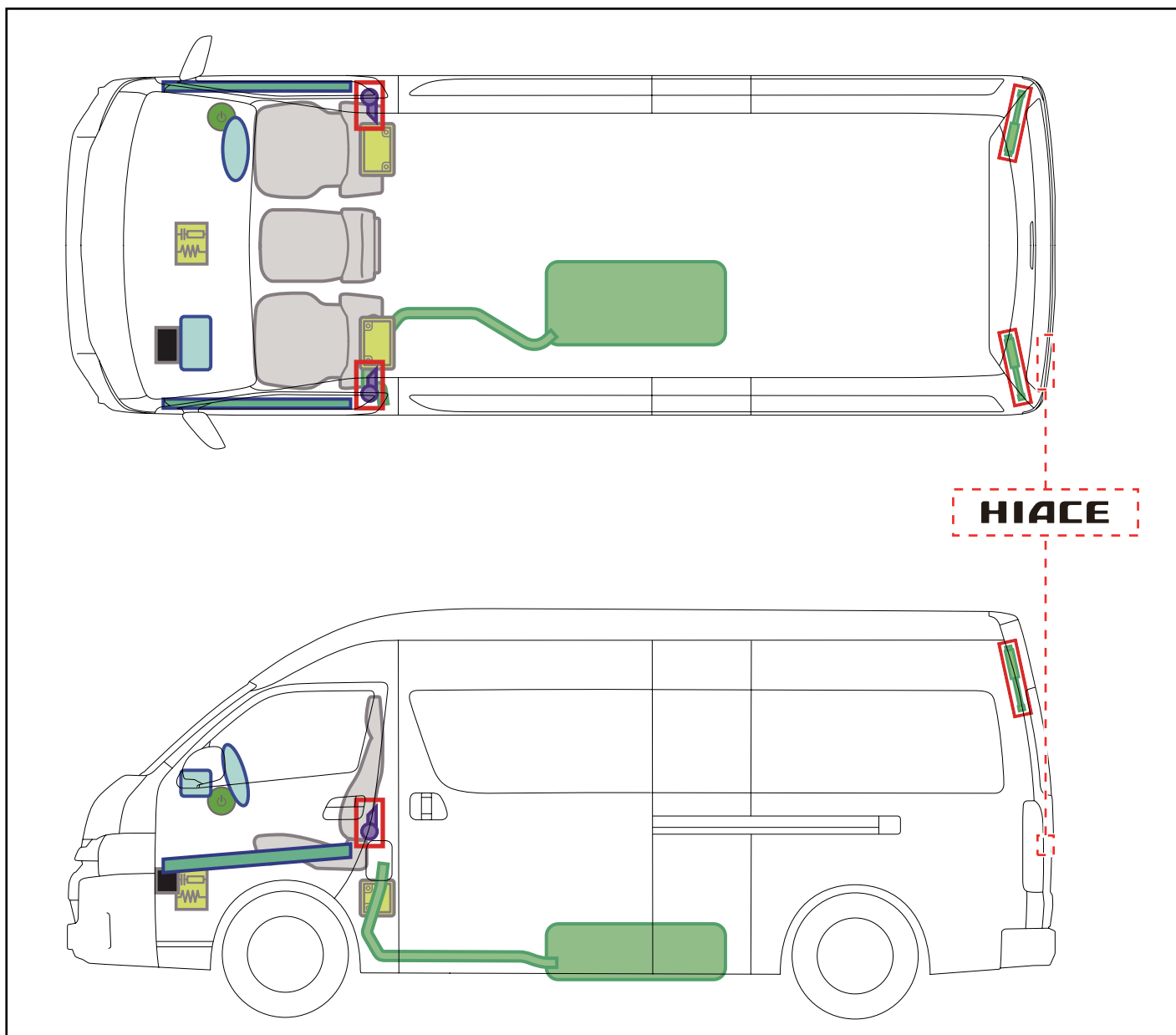

	IG SW		Fuse Box		12V Battery
	Airbag (incl. Inflator)		Fuel Tank		Gas-filled Damper
	Seat Belt Pretensioner (Gas Generator)		Structural Reinforcements		Airbag Computer
—	—	—	—	—	—
—	—	—	—	—	—

Disable Vehicle

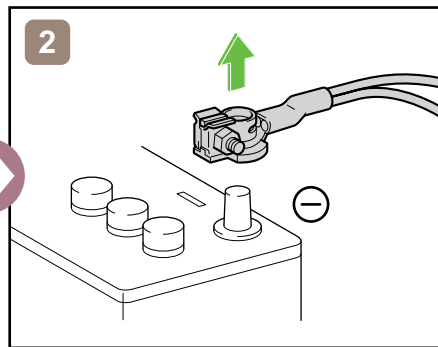
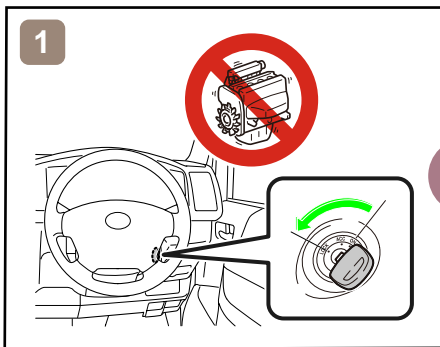

or

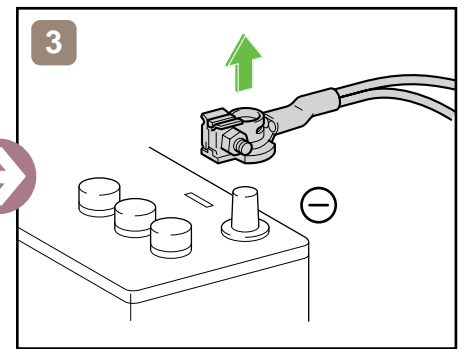
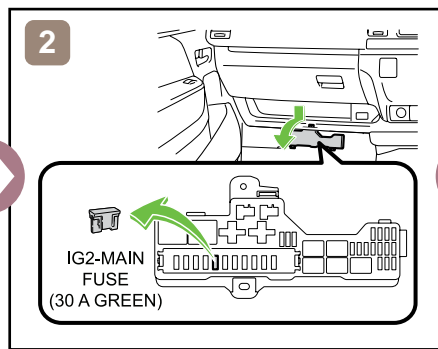
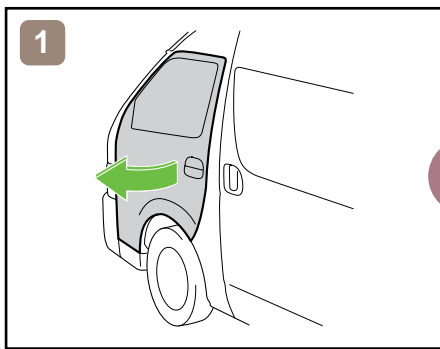

Access to 12V Battery

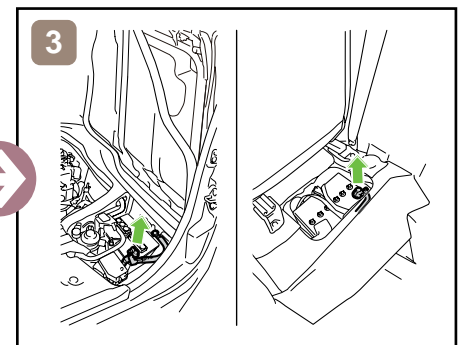
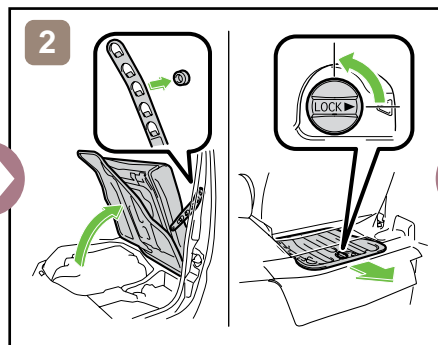
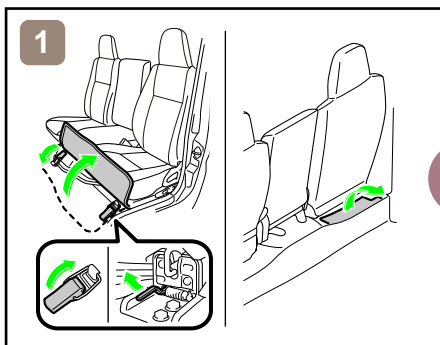

Towing Information

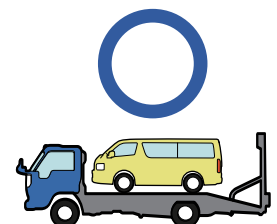
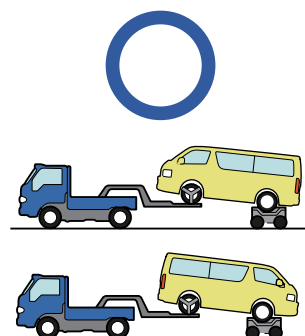
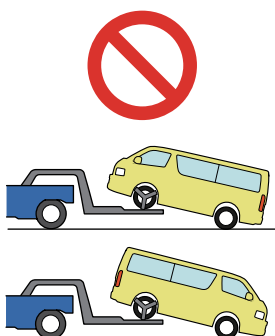

More details, please refer to "Emergency Response Guide".

HIACE
STANDARD ROOF
/ RHD
2019-2

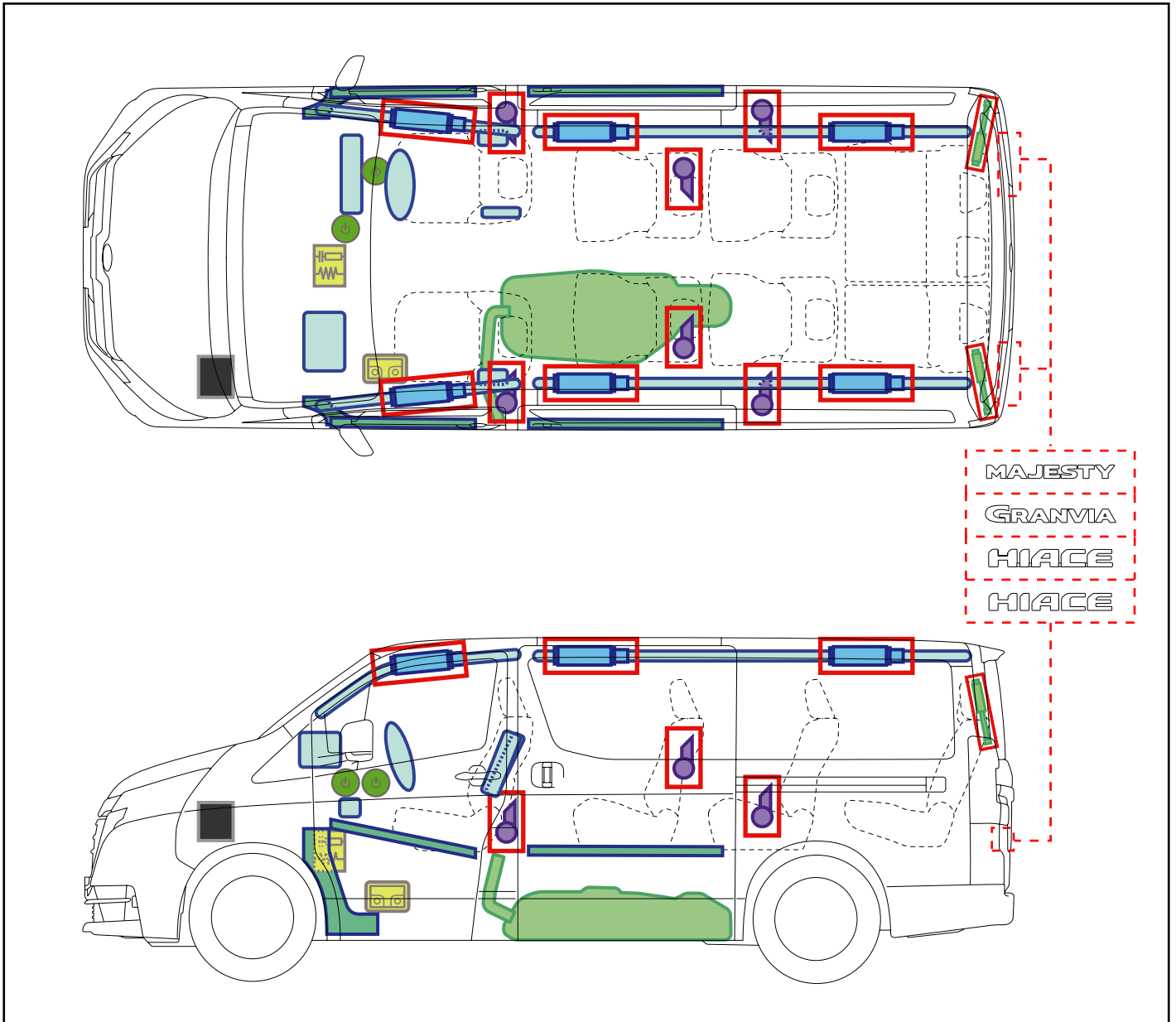
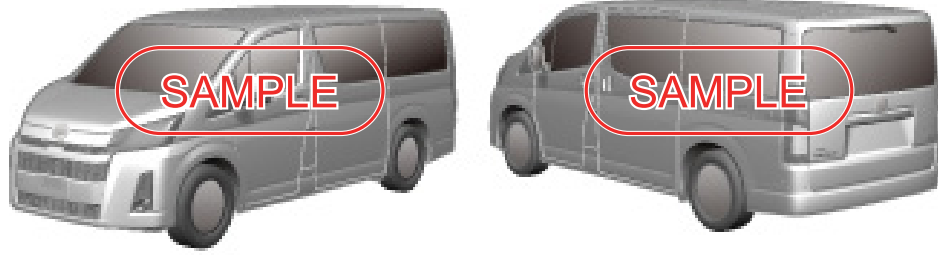

MAJESTY
GRANVIA
HIACE
HIACE

	IG/POWER SW		Fuse Box		12V Battery
	Airbag (incl. Inflator)		Inflator		Fuel Tank
	Gas-filled Damper		Seat Belt Pretensioner (Gas Generator)		Structural Reinforcements
	Airbag Computer	—	—	—	—
—	—	—	—	—	—

Disable Vehicle

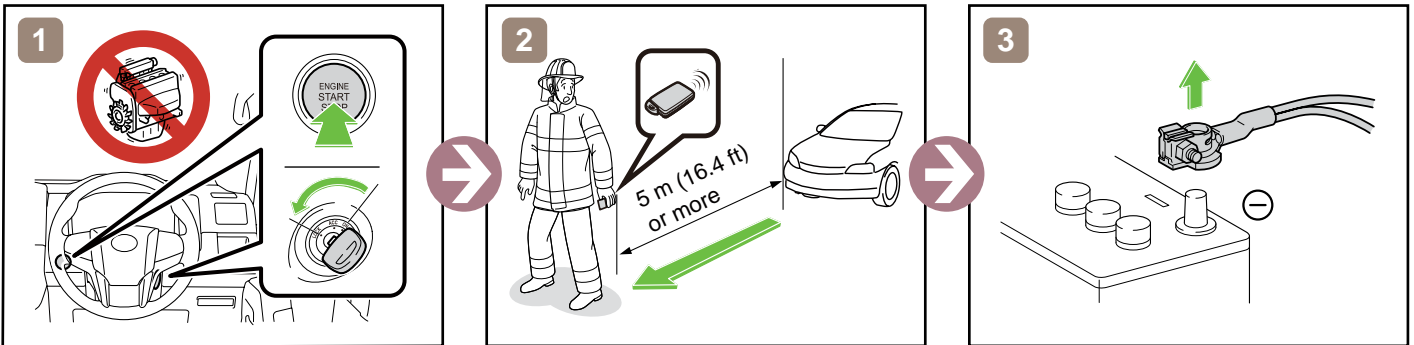

or

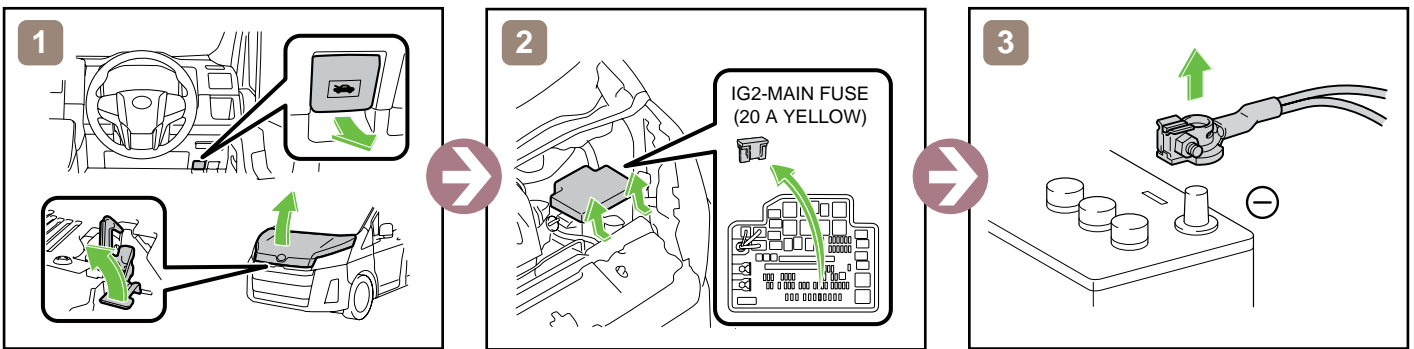

Access to 12V Battery

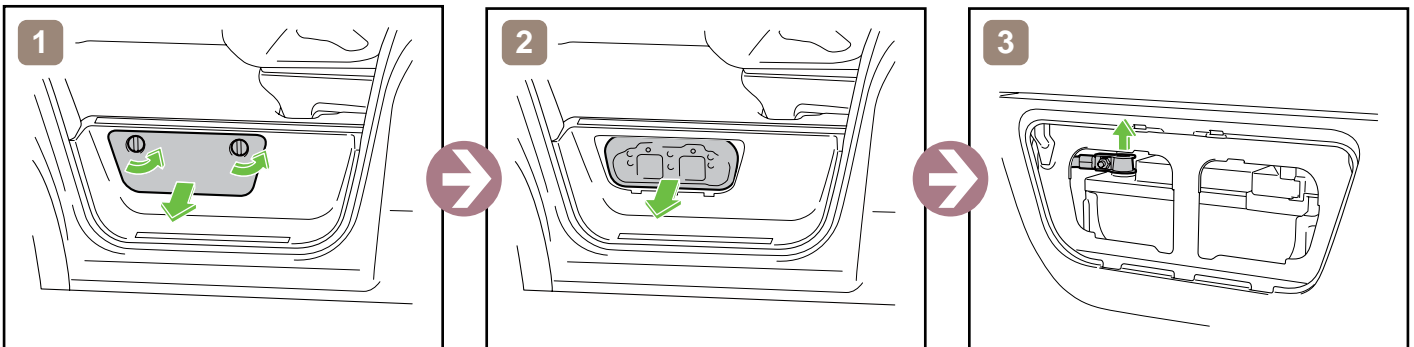

Towing Information

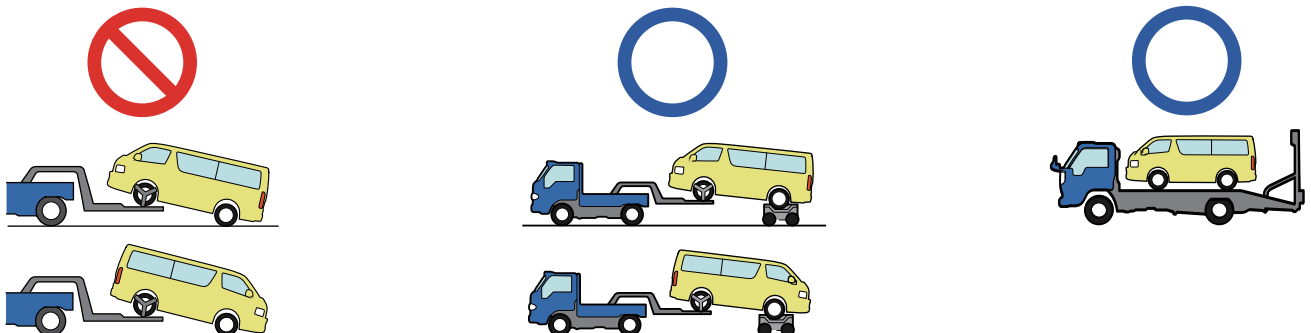







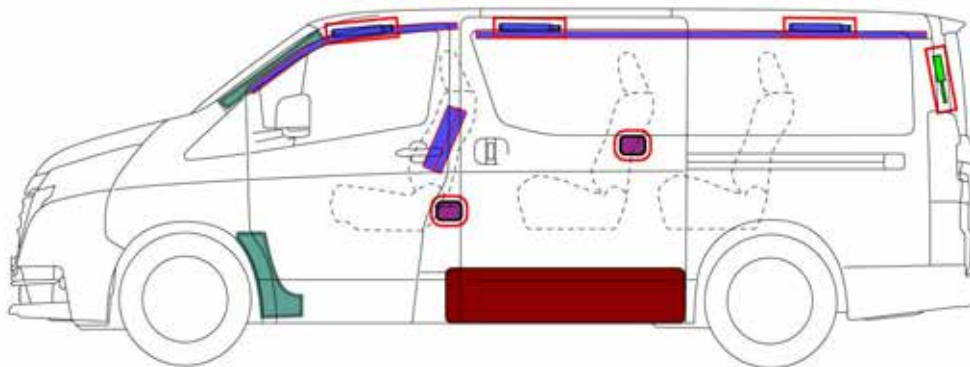
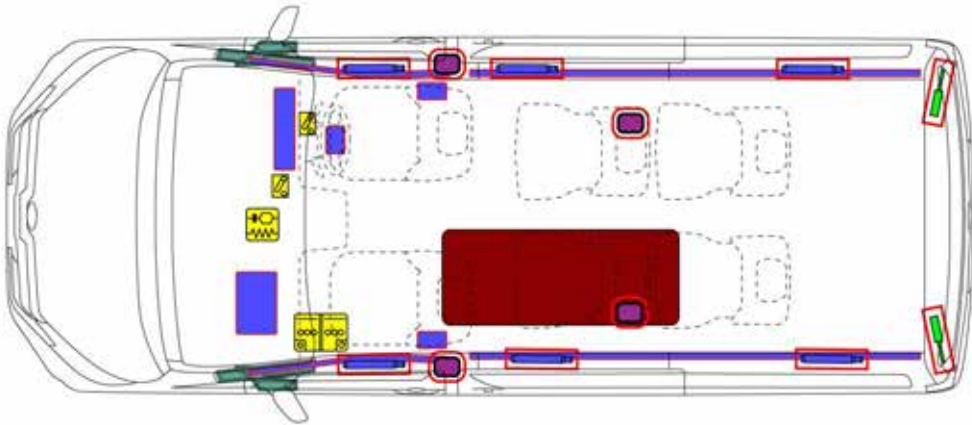

More details, please refer to "Emergency Response Guide".



TOYOTA HIACE / MAJESTY
 4 doors or 5 doors / 3 seats, 11 seats, 12 seats or 15 seats / wagon
 2025-06



	Airbag		Stored gas inflator		Seat belt pretensioner		SRS control unit		
	Gas strut / Preloaded spring		High strength zone						
	Battery low voltage		Fuel tank						
	Device to shut down power in vehicle								
Body Type: Standard Roof	ID No. HIACE300	Version No. 01	Version date 06 / 2025	Page 1 / 4					

1. Identification / Recognition

■ Location of vehicle badges

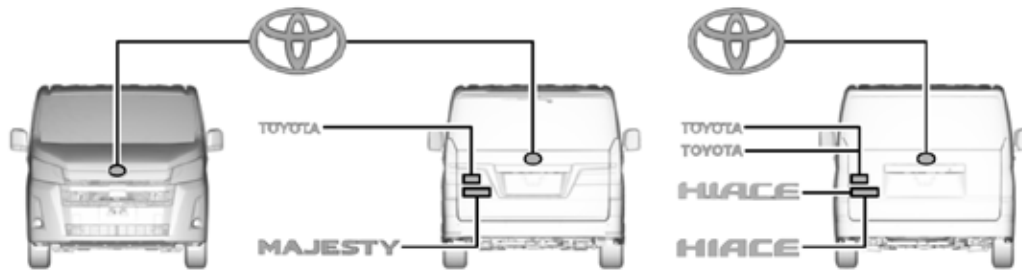

2. Immobilisation / Stabilisation / Lifting

■ Completely immobilize the vehicle

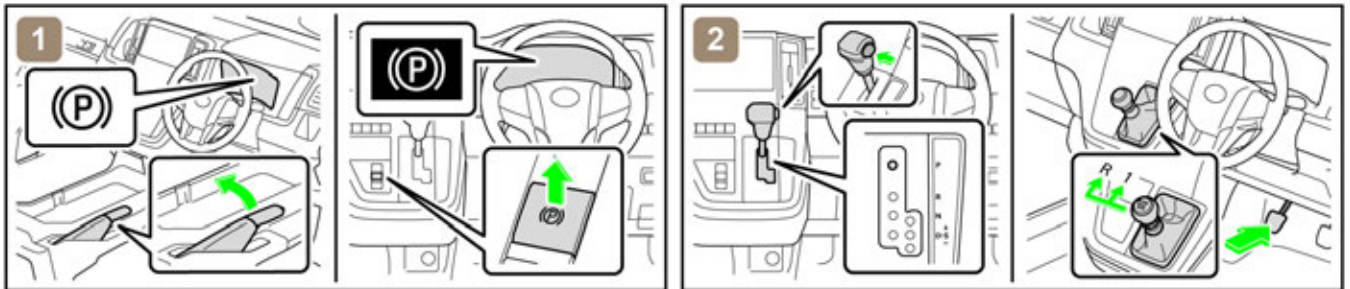

1) Chock the wheels and engage the parking brake.

2) Move the shift lever to the park (P) position.*1

2) Depress the clutch pedal and move the shift lever to the 1st or reverse (R) position.*2

*1: A/T

*2: M/T

■ Stabilisation-lifting point

Place cribbing such as wooden blocks at the four points under the front and rear pillars.

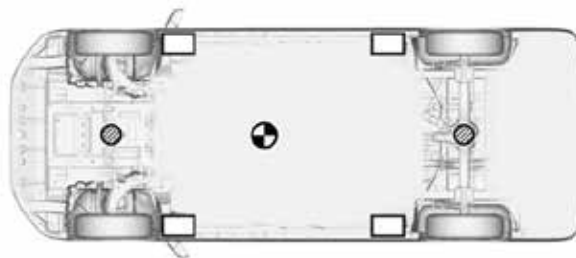

Extra Reinforced Lifting Points



Standard Jack Locations



Vehicle Center of Gravity



Do not place cribbing such as wooden blocks or rescue air lifting bags under the exhaust system or fuel system. Doing so may result in fuel leaks or fire.

Body Type: Standard Roof	ID No. HIACE300	Version No. 01	Version date 06 / 2025	Page 2 / 4
-----------------------------	--------------------	-------------------	---------------------------	---------------

3. Disable direct hazards / Safety regulations

■ If any of the following systems are required to be operated, operate them **BEFORE** disconnecting the battery.

Power door lock
Electric parking brake

Power window

Power seat

When the 12 V battery is disconnected, electrical components cannot be operated.

■ Perform procedure Main or Alternative to completely shut off the vehicle.

<Main Procedure>

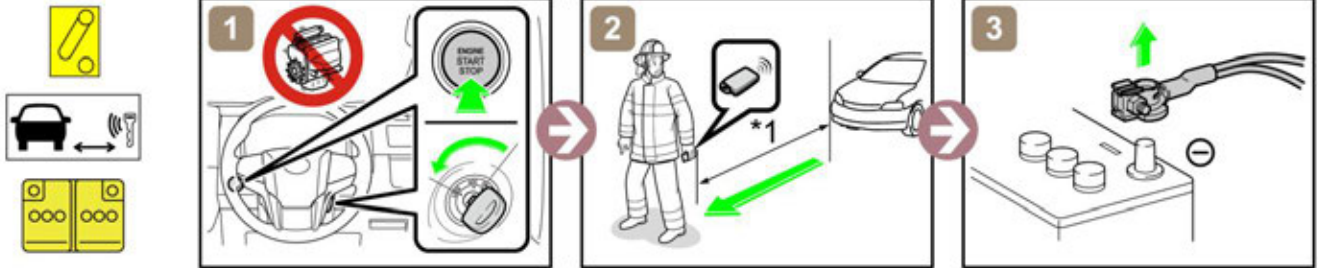

*1: 5 m (16.4 ft) or more

<Alternative Procedure>

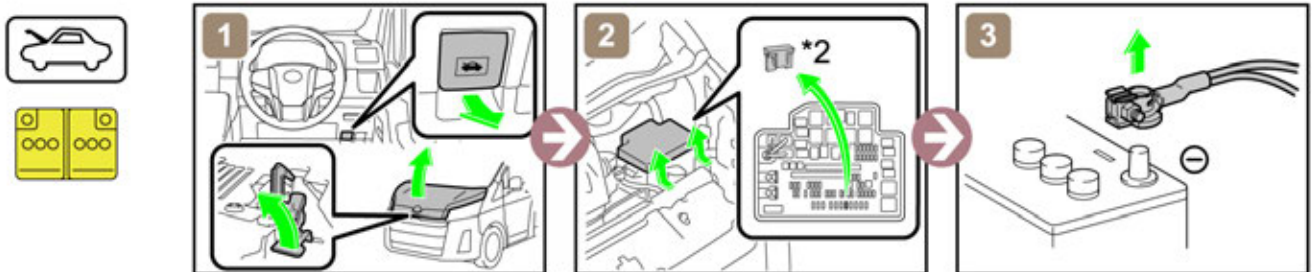

*2: IG2-MAIN FUSE (20 A YELLOW)

■ Access to 12 V Battery

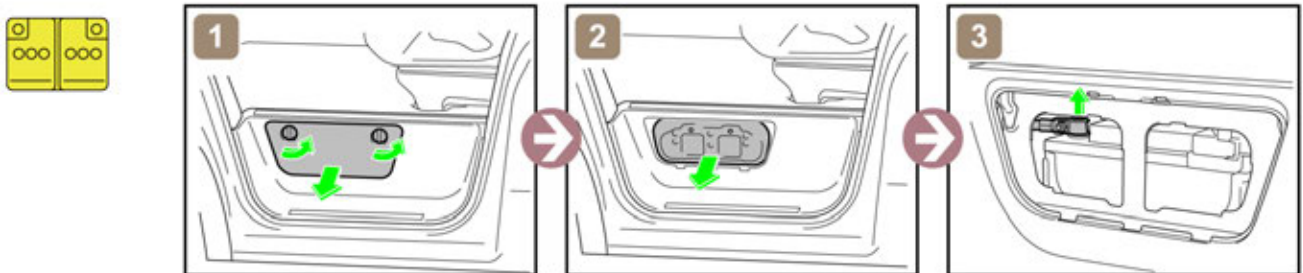

4. Access to the occupants

■ Window Glass

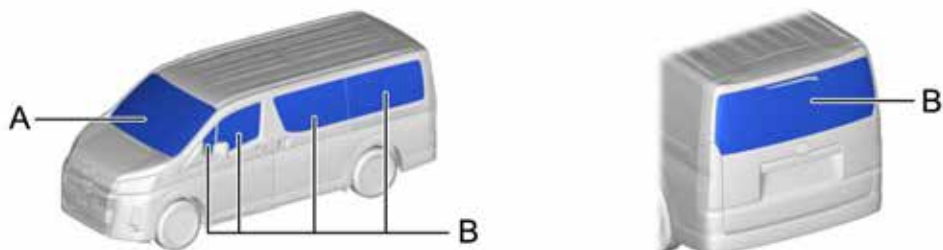

A	Laminated	B	Tempered
---	-----------	---	----------

Body Type: Standard Roof	ID No. HIACE300	Version No. 01	Version date 06 / 2025	Page 3 / 4
-----------------------------	--------------------	-------------------	---------------------------	---------------

5. Stored energy / Liquids / Gases / Solids



12 V Battery



Gasoline Tank: 70 L



Always wear appropriate personal protective equipment (PPE) when dealing with any of these items.

6. In case of fire



RE-IGNITION POSSIBLE !



Gas strut / Preloaded spring

As it is possible for a gas strut / preloaded spring to become a projectile, refer to the component layout drawing.

7. In case of submersion



Work on the vehicle only after the vehicle has been pulled out of the water.

8. Towing / Transportation / Storage

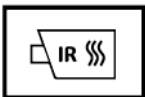
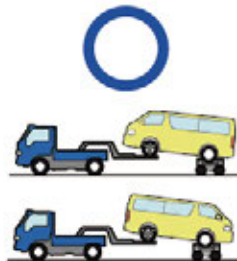
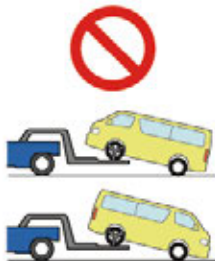

RE-IGNITION POSSIBLE !

Store the vehicle at a safe distance (15 m (49.2 ft) or more) from other vehicles.

9. Important additional information









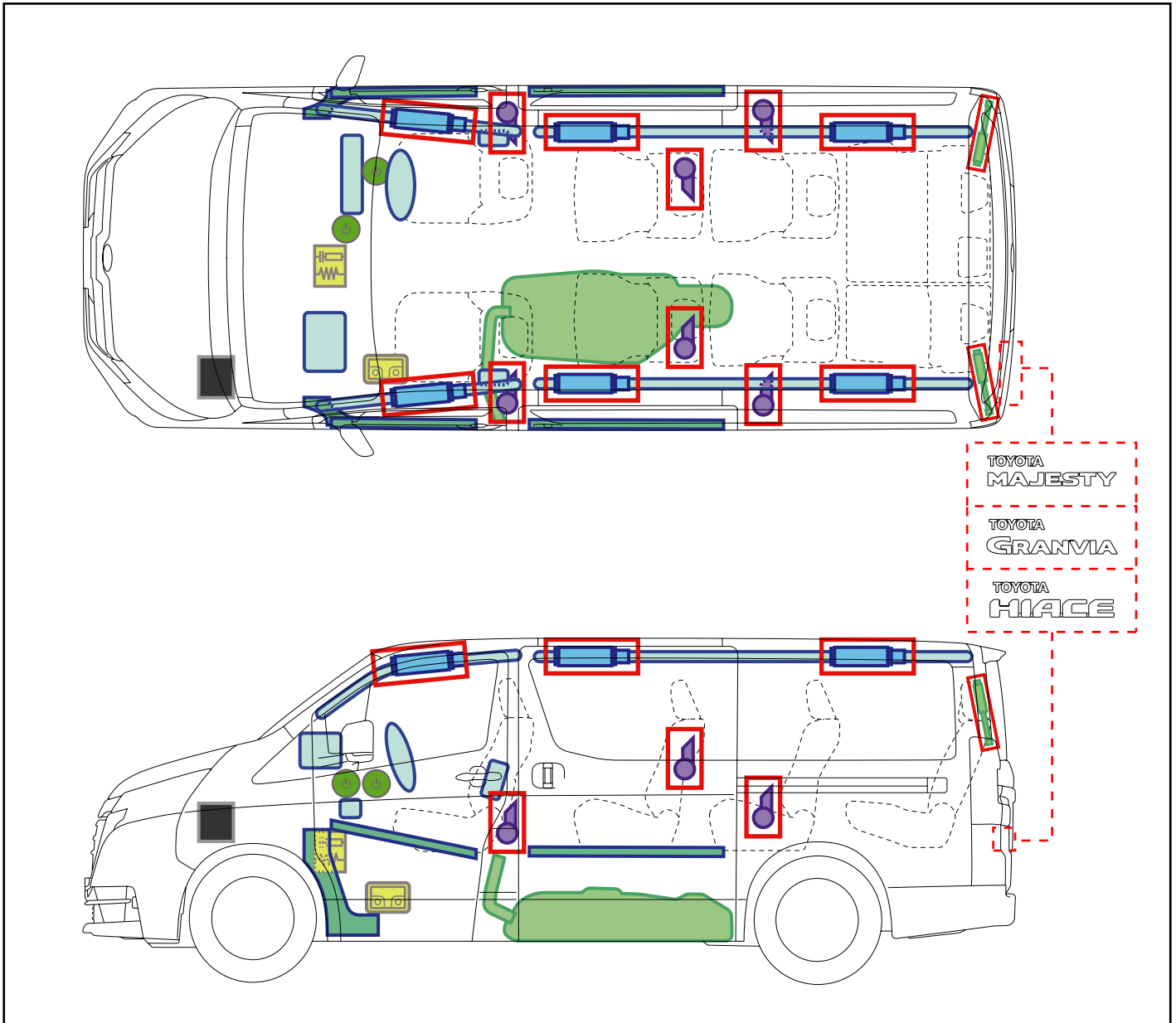
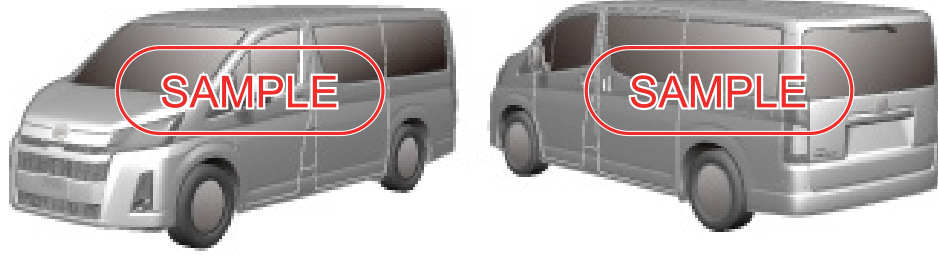

For further details, please refer to "Emergency Response Guide".

Body Type: Standard Roof	ID No. HIACE300	Version No. 01	Version date 06 / 2025	Page 4 / 4
-----------------------------	--------------------	-------------------	---------------------------	---------------

HIACE/ GRANVIA

STANDARD
ROOF / RHD
2019-2



	IG/POWER SW		Fuse Box		12V Battery
	Airbag (incl. Inflator)		Inflator		Fuel Tank
	Gas-filled Damper		Seat Belt Pretensioner (Gas Generator)		Structural Reinforcements
	Airbag Computer	—	—	—	—
—	—	—	—	—	—

Disable Vehicle

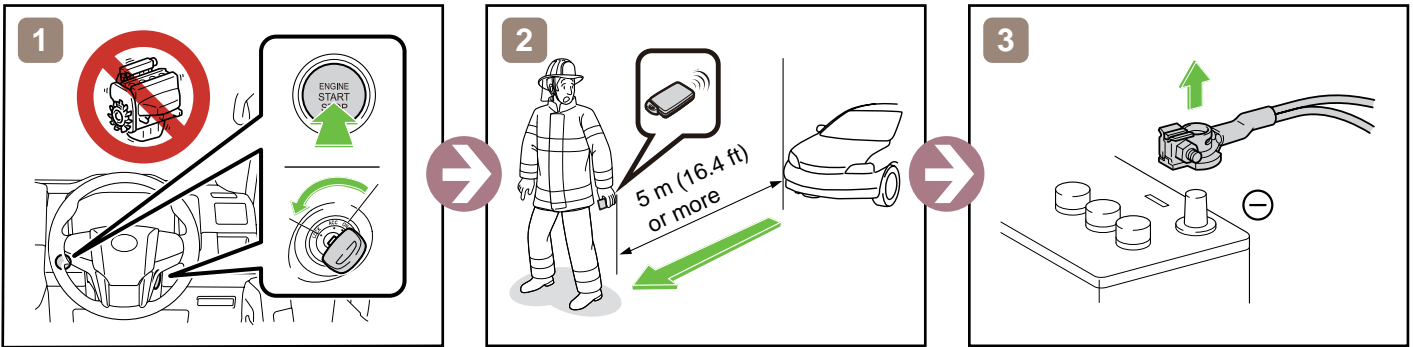

or

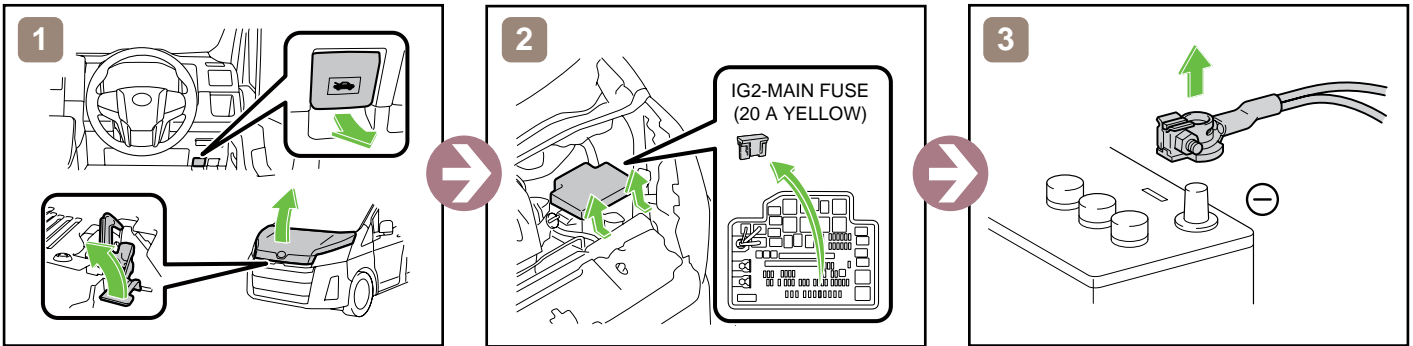

Access to 12V Battery

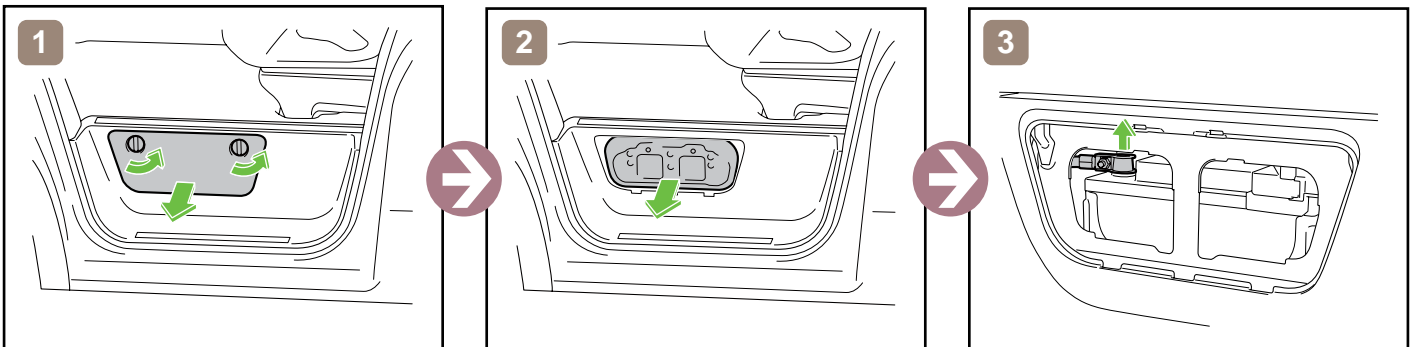

Towing Information

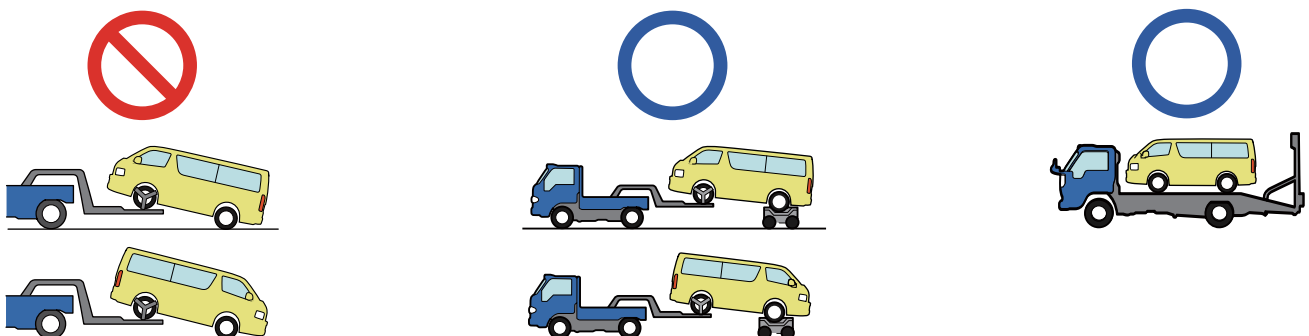

More details, please refer to "Emergency Response Guide".

HIACE

HIGH ROOF / RHD

2019-2

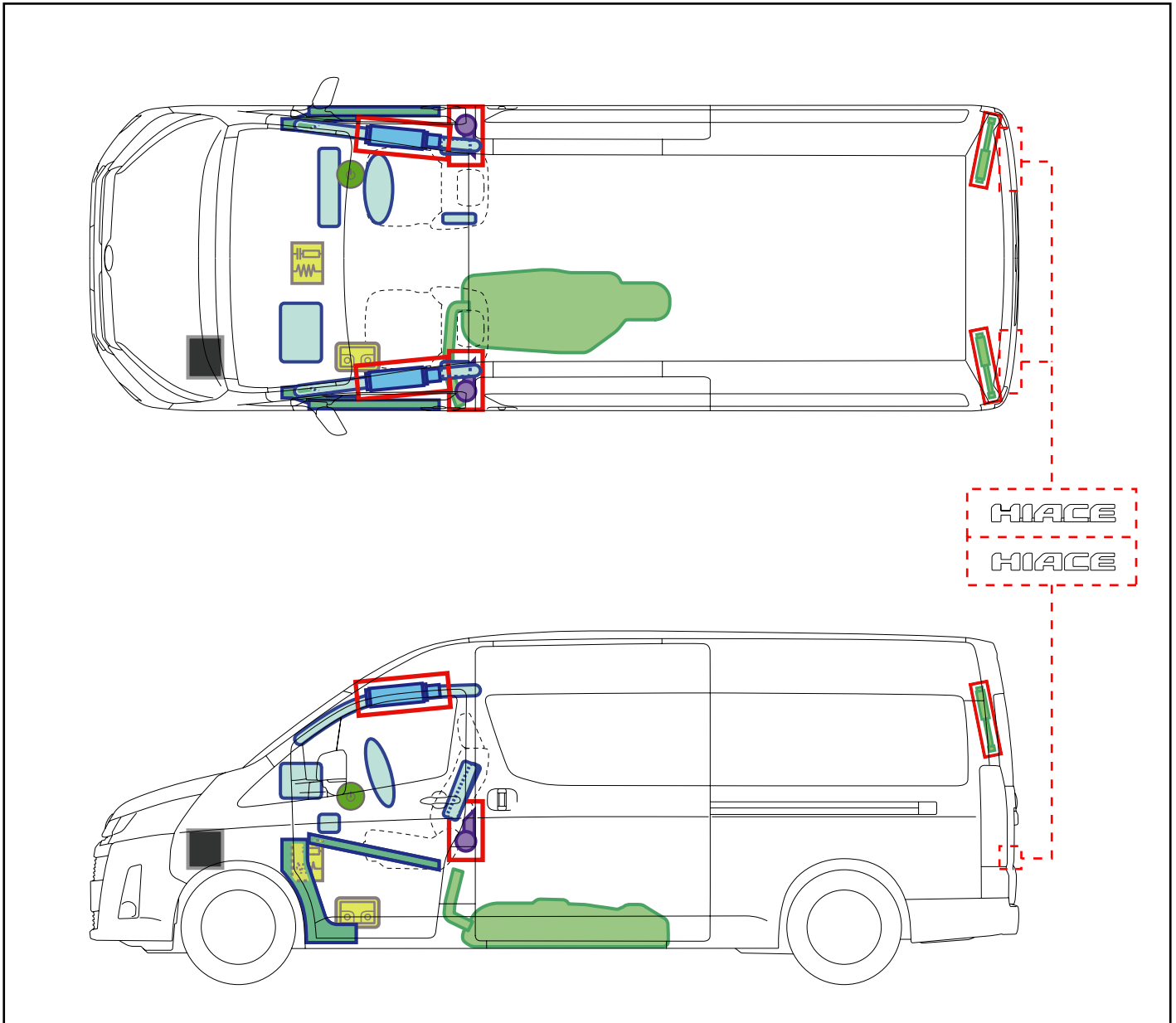
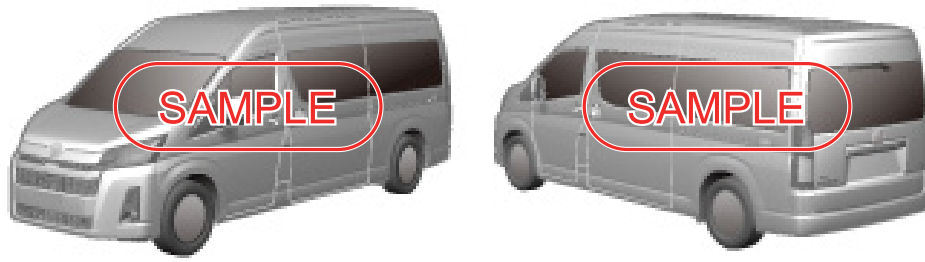

	IG/POWER SW		Fuse Box		12V Battery
	Airbag (incl. Inflator)		Inflator		Fuel Tank
	Gas-filled Damper		Seat Belt Pretensioner (Gas Generator)		Structural Reinforcements
	Airbag Computer	—	—	—	—
—	—	—	—	—	—

Disable Vehicle

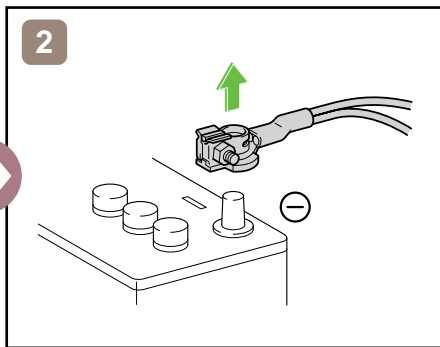
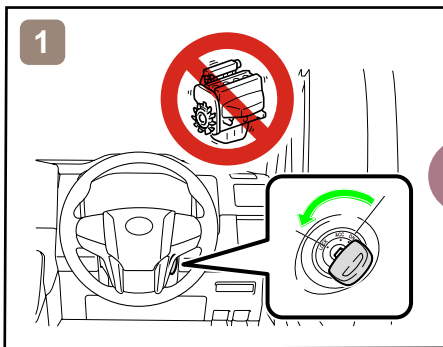

or

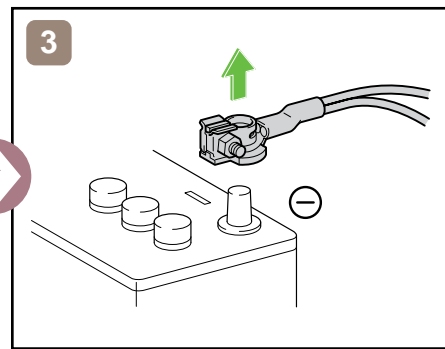
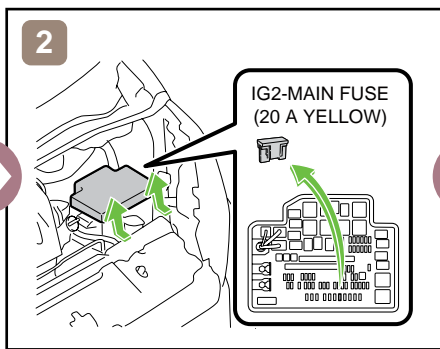
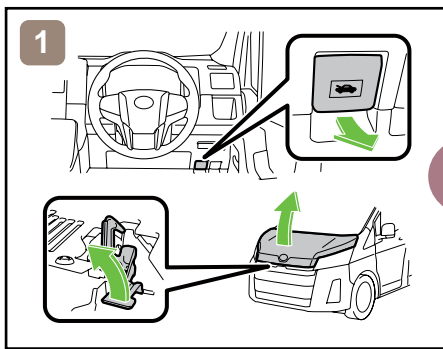

Access to 12V Battery

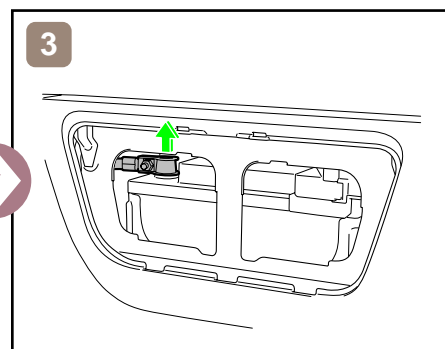
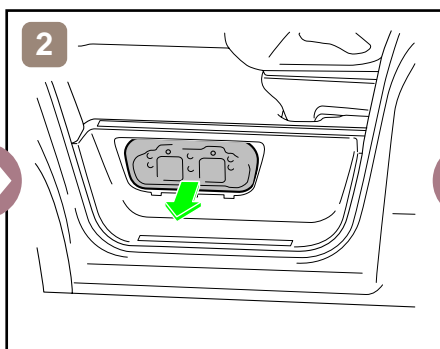
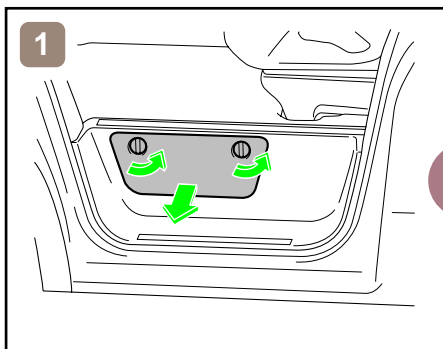

Towing Information

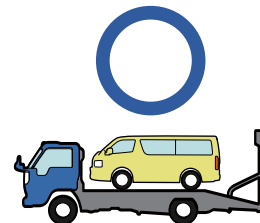
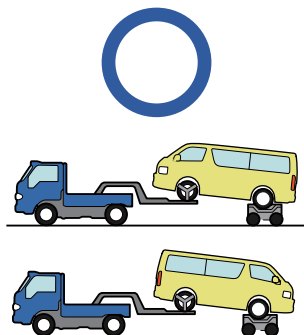
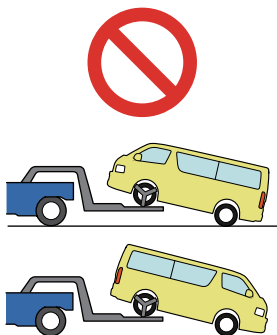







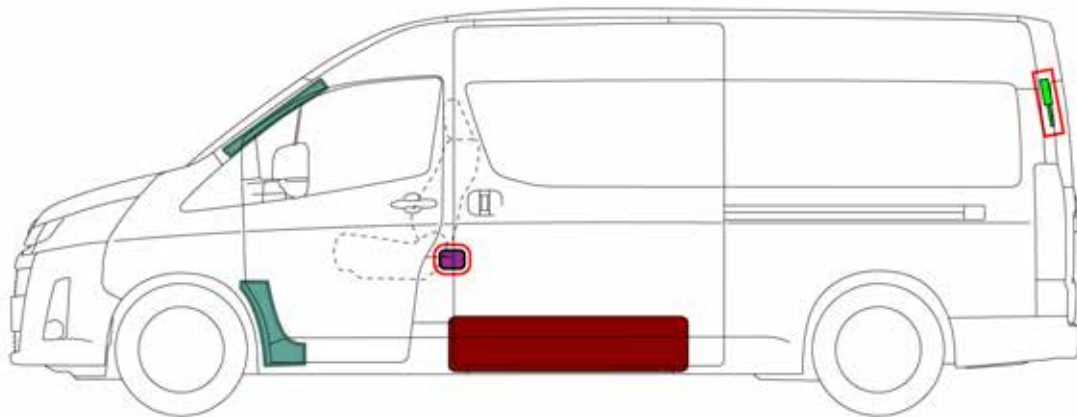
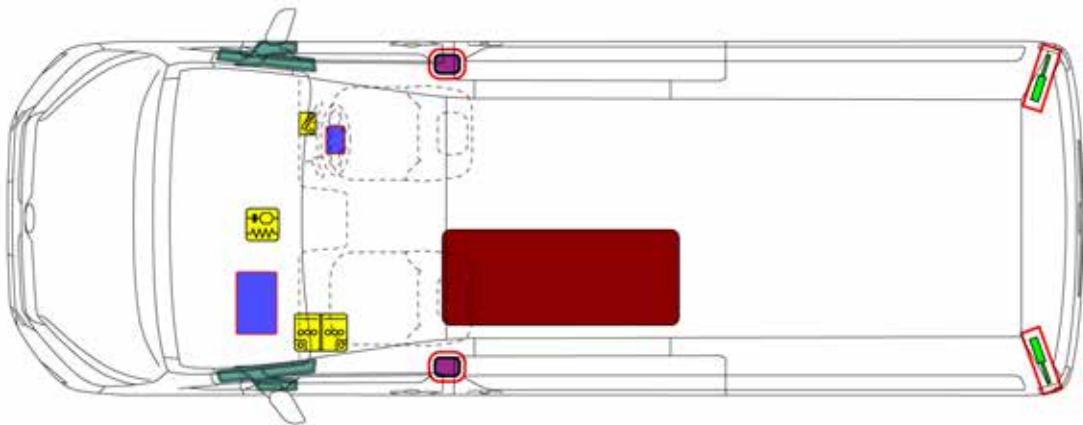
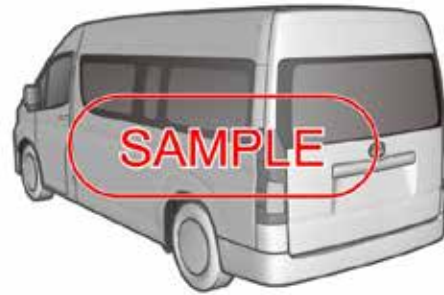
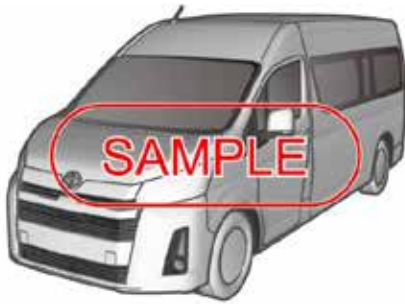

More details, please refer to "Emergency Response Guide".



TOYOTA HIACE
4 doors / 3 seats, 16 seats or 17 seats / wagon
2025-06



	Airbag		Stored gas inflator		Seat belt pretensioner		SRS control unit		
	Gas strut / Preloaded spring		High strength zone						
	Battery low voltage		Fuel tank						
	Device to shut down power in vehicle								
Body Type: High Roof	ID No. HIACE320	Version No. 01	Version date 06 / 2025	Page 1 / 4					

1. Identification / Recognition

■ Location of vehicle badges



2. Immobilisation / Stabilisation / Lifting

■ Completely immobilize the vehicle

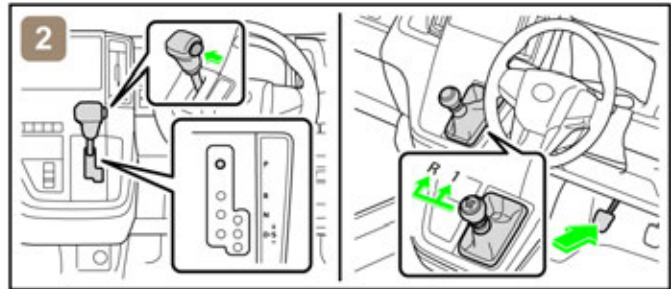
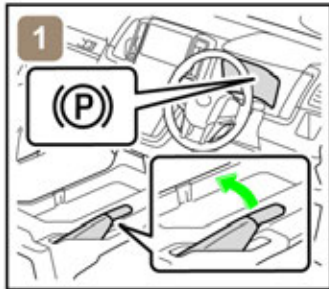

1) Chock the wheels and engage the parking brake.

2) Move the shift lever to the park (P) position.*1

2) Depress the clutch pedal and move the shift lever to the 1st or reverse (R) position.*2

*1: A/T

*2: M/T

■ Stabilisation-lifting point

Place cribbing such as wooden blocks at the four points under the front and rear pillars.

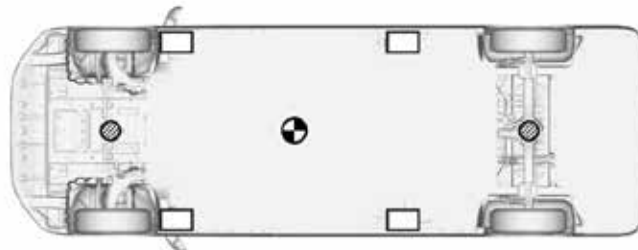

Extra Reinforced Lifting Points



Standard Jack Locations



Vehicle Center of Gravity



Do not place cribbing such as wooden blocks or rescue air lifting bags under the exhaust system or fuel system. Doing so may result in fuel leaks or fire.

Body Type: High Roof	ID No.	Version No.	Version date	Page
	HIACE320	01	06 / 2025	2 / 4

3. Disable direct hazards / Safety regulations

■ If any of the following systems are required to be operated, operate them **BEFORE** disconnecting the battery.

Power door lock

Power window

When the 12 V battery is disconnected, electrical components cannot be operated.

■ Perform procedure Main or Alternative to completely shut off the vehicle.

<Main Procedure>

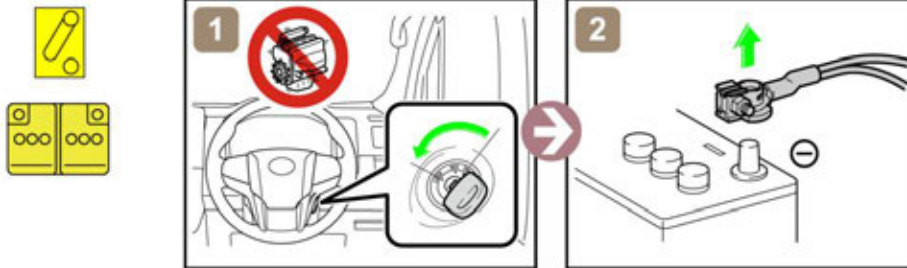

<Alternative Procedure>

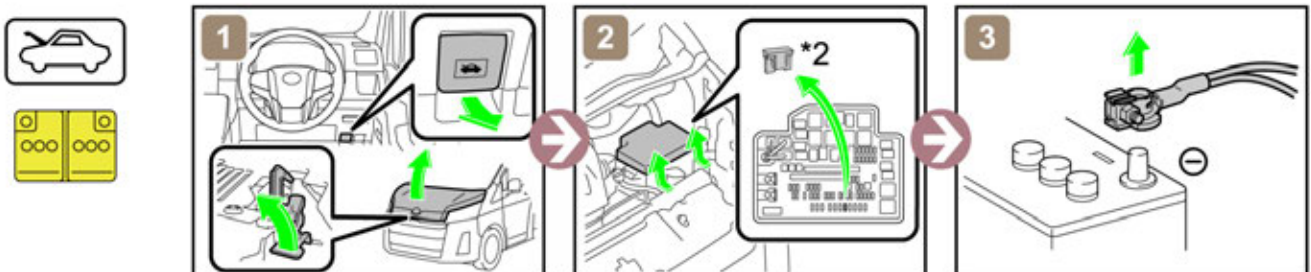

*2: IG2-MAIN FUSE (20 A YELLOW)

■ Access to 12 V Battery

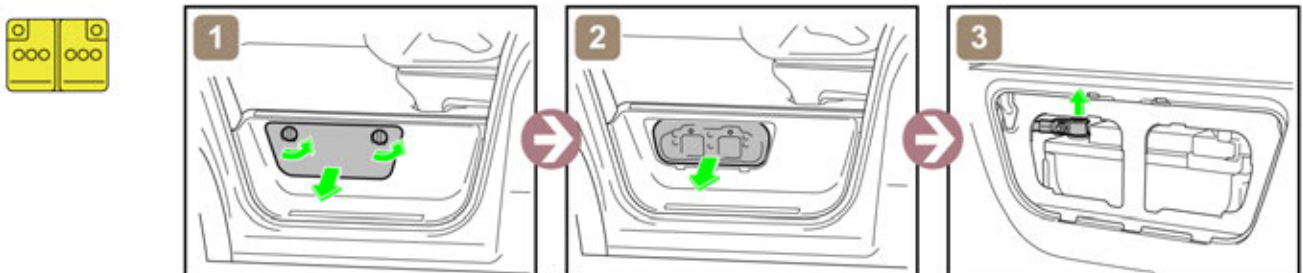

4. Access to the occupants

■ Window Glass

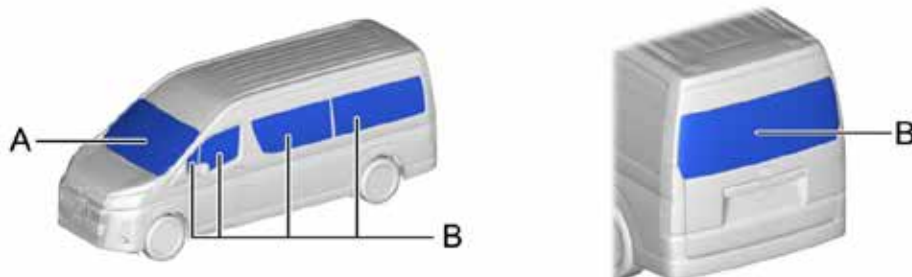

A	Laminated	B	Tempered
---	-----------	---	----------

Body Type: High Roof	ID No. HIACE320	Version No. 01	Version date 06 / 2025	Page 3 / 4
-------------------------	--------------------	-------------------	---------------------------	---------------

5. Stored energy / Liquids / Gases / Solids



12 V Battery



Gasoline Tank: 70 L



Always wear appropriate personal protective equipment (PPE) when dealing with any of these items.

6. In case of fire



RE-IGNITION POSSIBLE !



Gas strut / Preloaded spring

As it is possible for a gas strut / preloaded spring to become a projectile, refer to the component layout drawing.

7. In case of submersion



Work on the vehicle only after the vehicle has been pulled out of the water.

8. Towing / Transportation / Storage

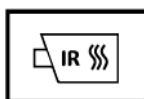
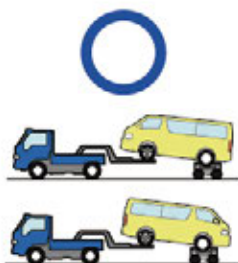
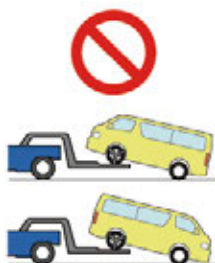

RE-IGNITION POSSIBLE !

Store the vehicle at a safe distance (15 m (49.2 ft) or more) from other vehicles.

9. Important additional information

For further details, please refer to "Emergency Response Guide".

Body Type:
High Roof

ID No.
HIACE320

Version No.
01

Version date
06 / 2025

Page
4 / 4

HILUX
DOUBLE CAB /
RHD
2015-5

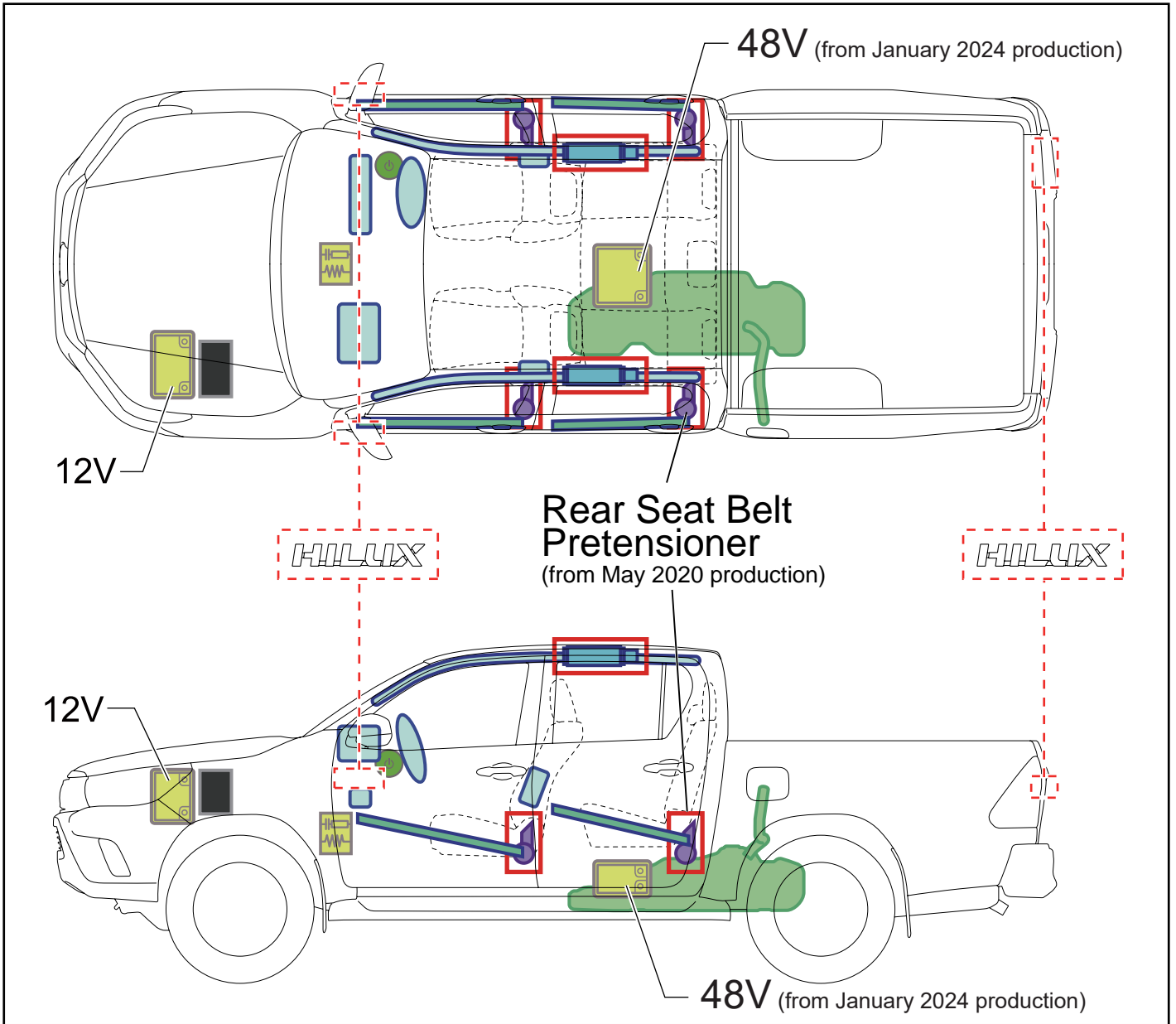
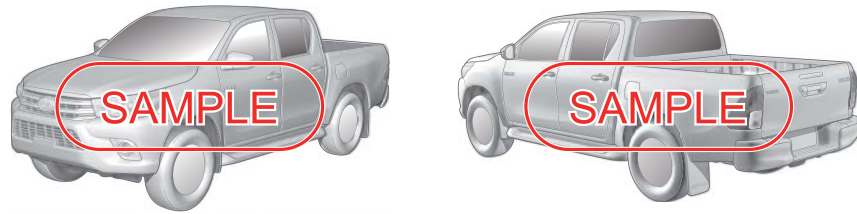

	IG/POWER SW		Fuse Box		Battery Low Voltage
	Airbag (incl. Inflator)		Inflator		Fuel Tank
	Seat Belt Pretensioner (Gas Generator)		Structural Reinforcements		Airbag Computer
—	—	—	—	—	—
—	—	—	—	—	—

Disable Vehicle

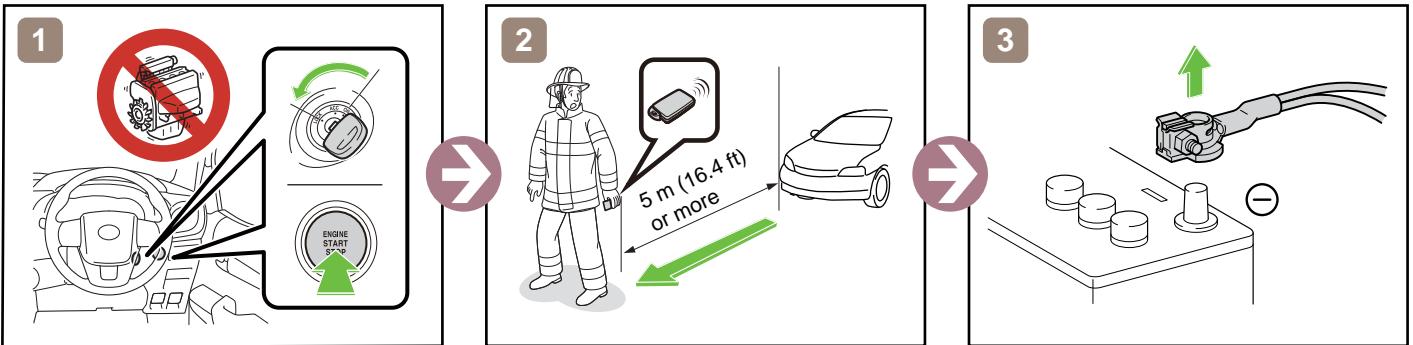

or

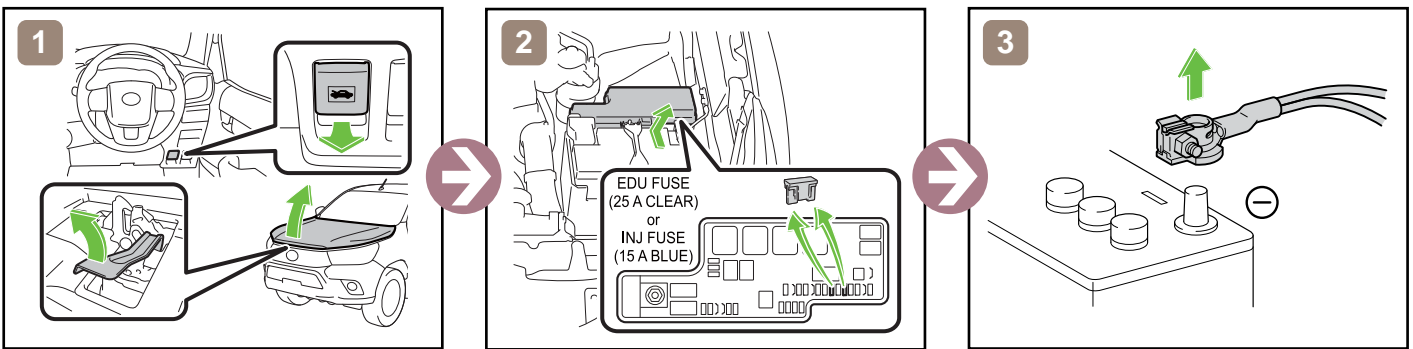

Access to 12V Battery

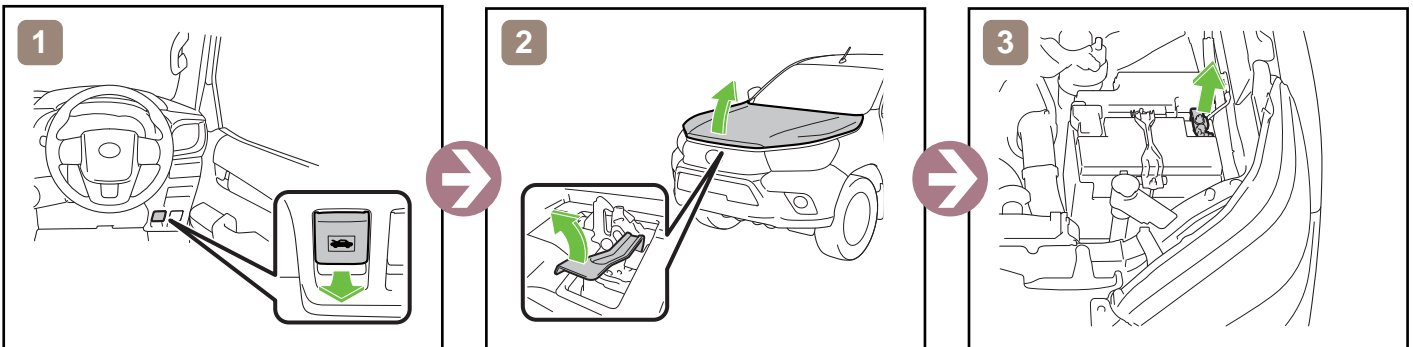

Towing Information

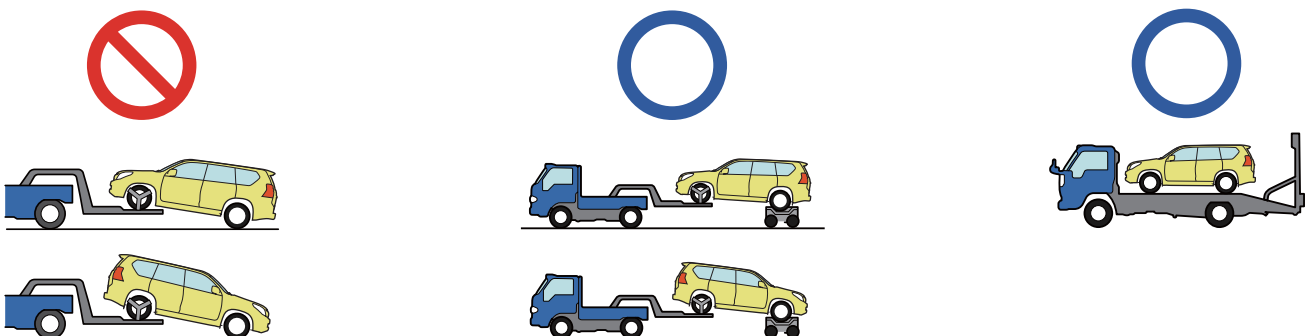

More details, please refer to "Emergency Response Guide".

HILUX
SINGLE CAB /
RHD
2015-5

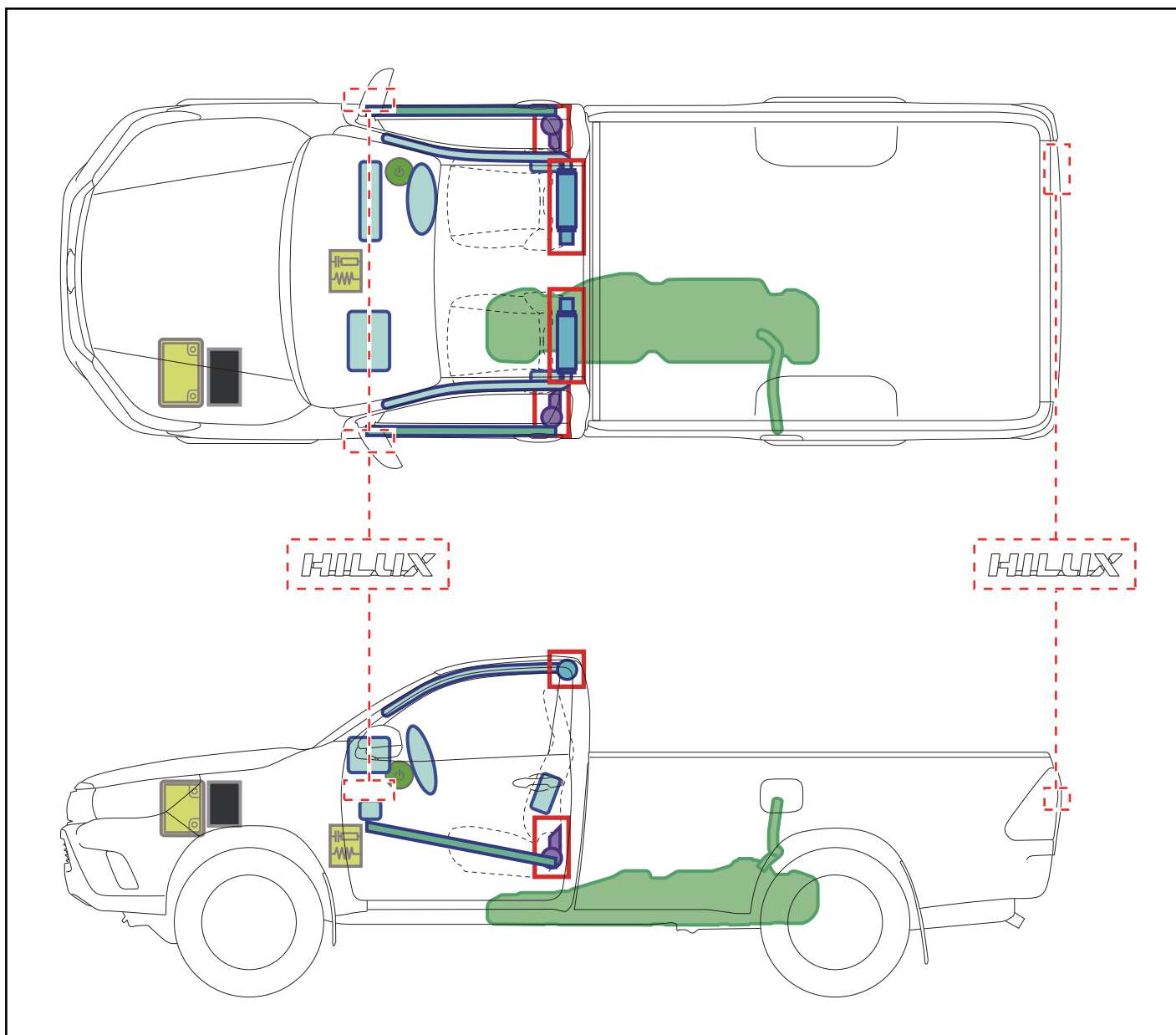
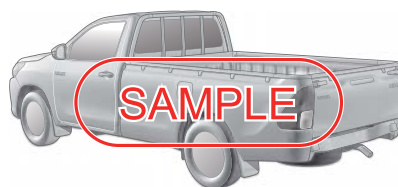
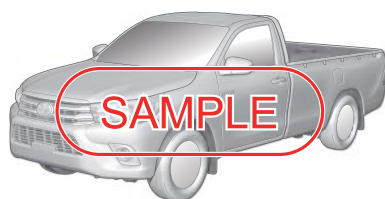

	IG/POWER SW		Fuse Box		12V Battery
	Airbag (incl. Inflator)		Inflator		Fuel Tank
	Seat Belt Pretensioner (Gas Generator)		Structural Reinforcements		Airbag Computer
—	—	—	—	—	—
—	—	—	—	—	—

Disable Vehicle

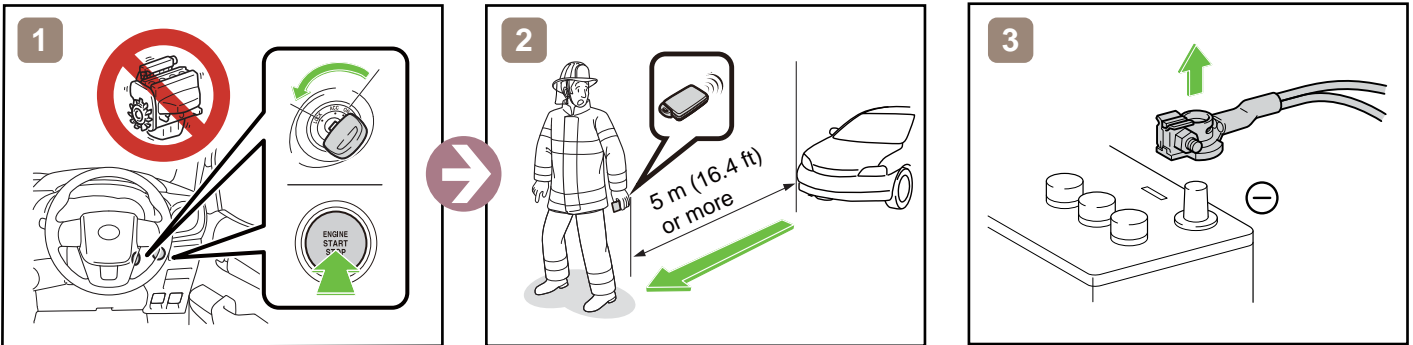

or

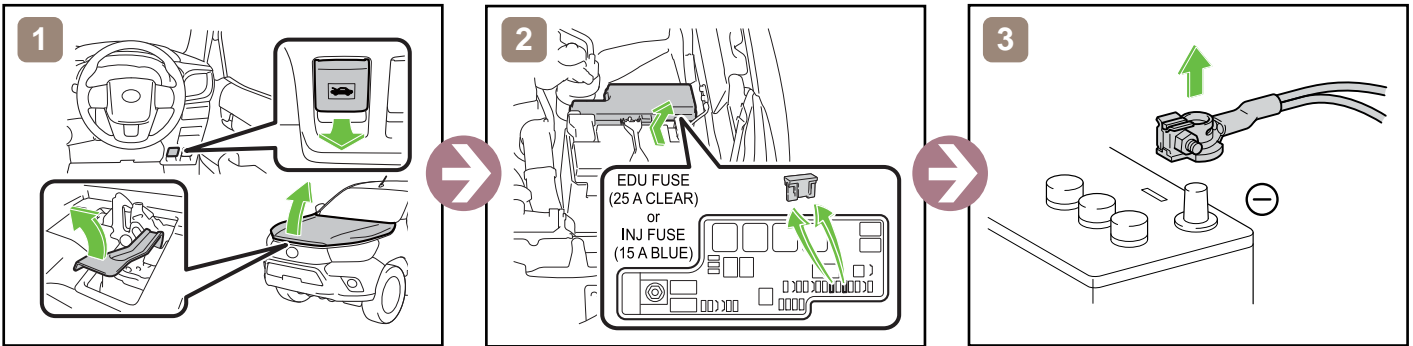

Access to 12V Battery

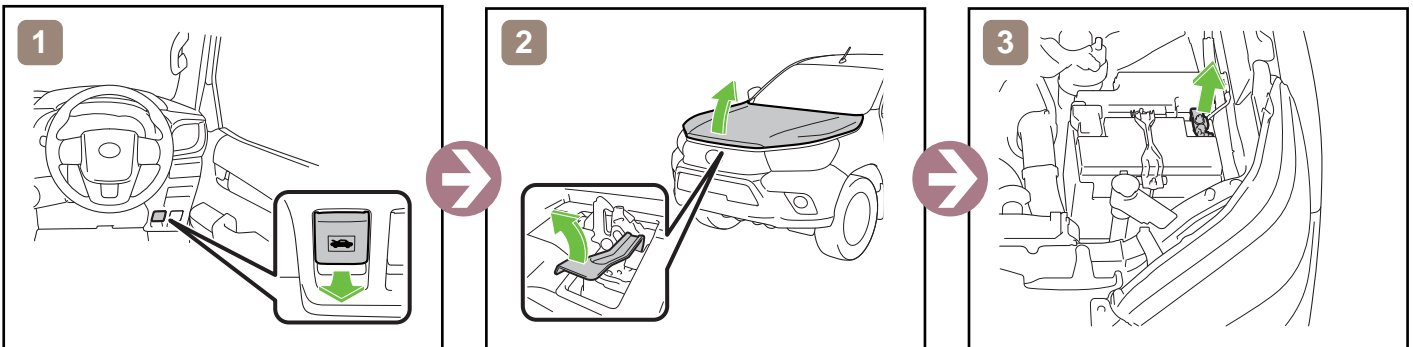

Towing Information

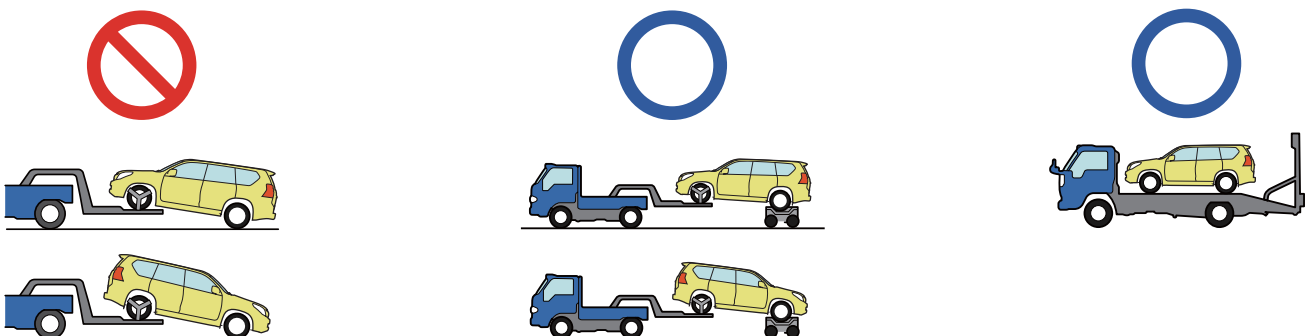

More details, please refer to "Emergency Response Guide".

HILUX
SMART CAB /
RHD
2015-5

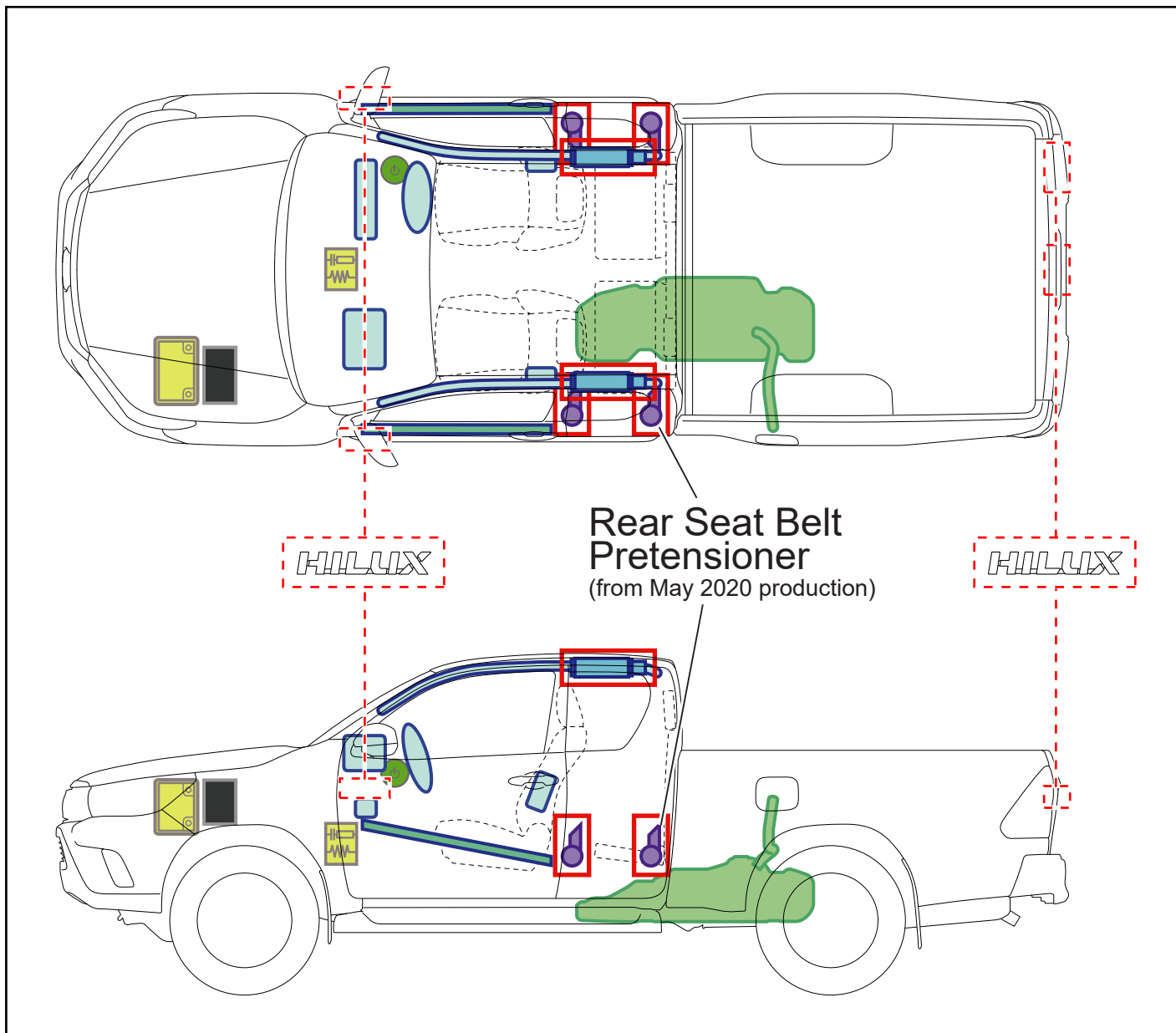
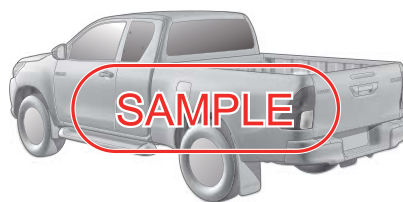
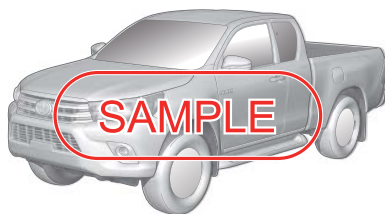

	IG/POWER SW		Fuse Box		12V Battery
	Airbag (incl. Inflator)		Inflator		Fuel Tank
	Seat Belt Pretensioner (Gas Generator)		Structural Reinforcements		Airbag Computer
—	—	—	—	—	—
—	—	—	—	—	—

Disable Vehicle

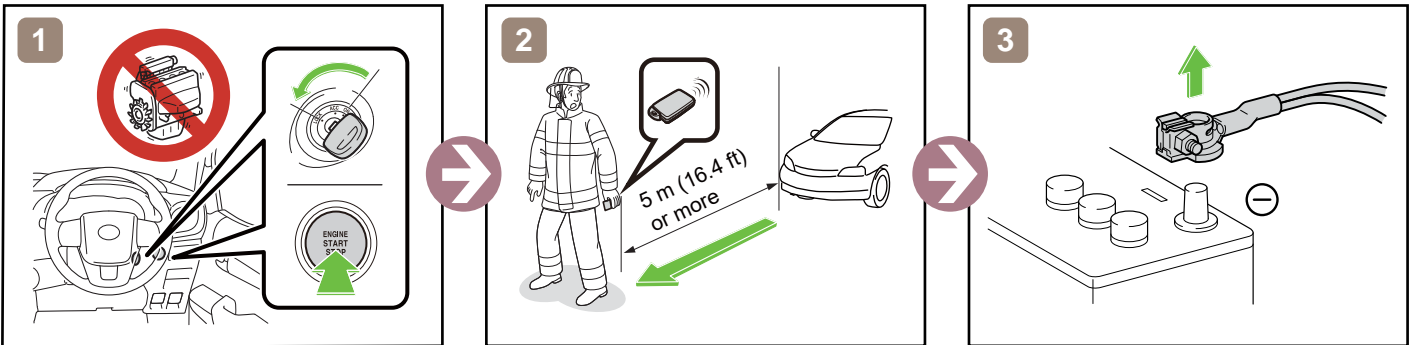

or

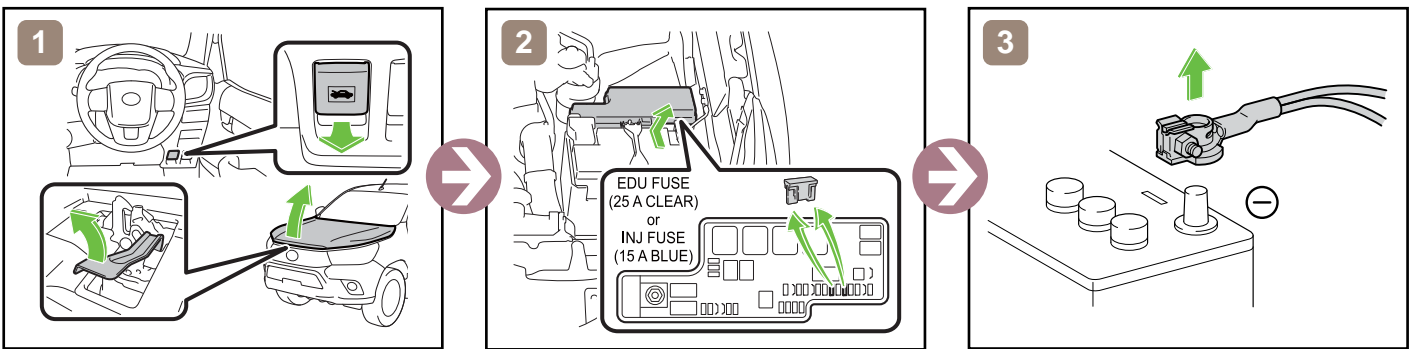

Access to 12V Battery

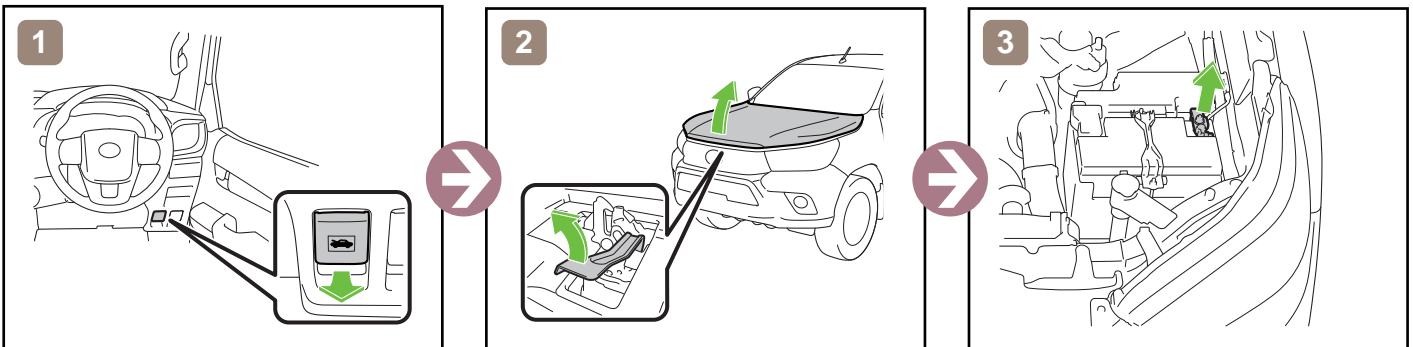

Towing Information

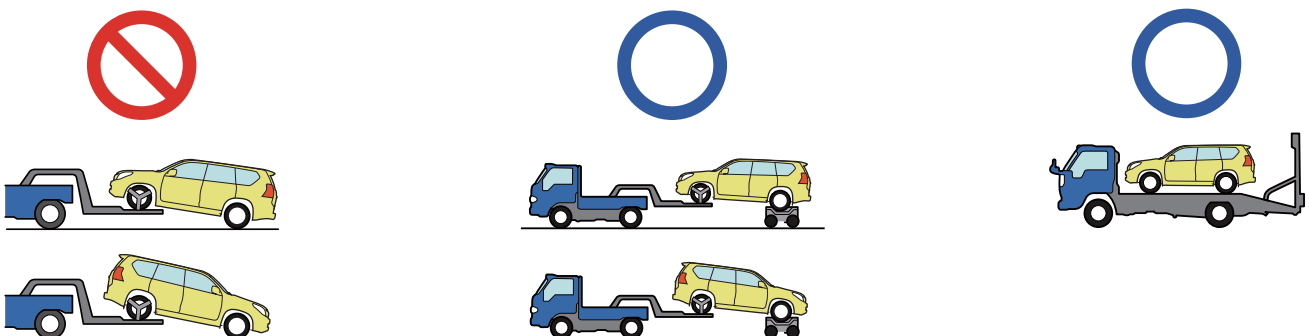

More details, please refer to "Emergency Response Guide".

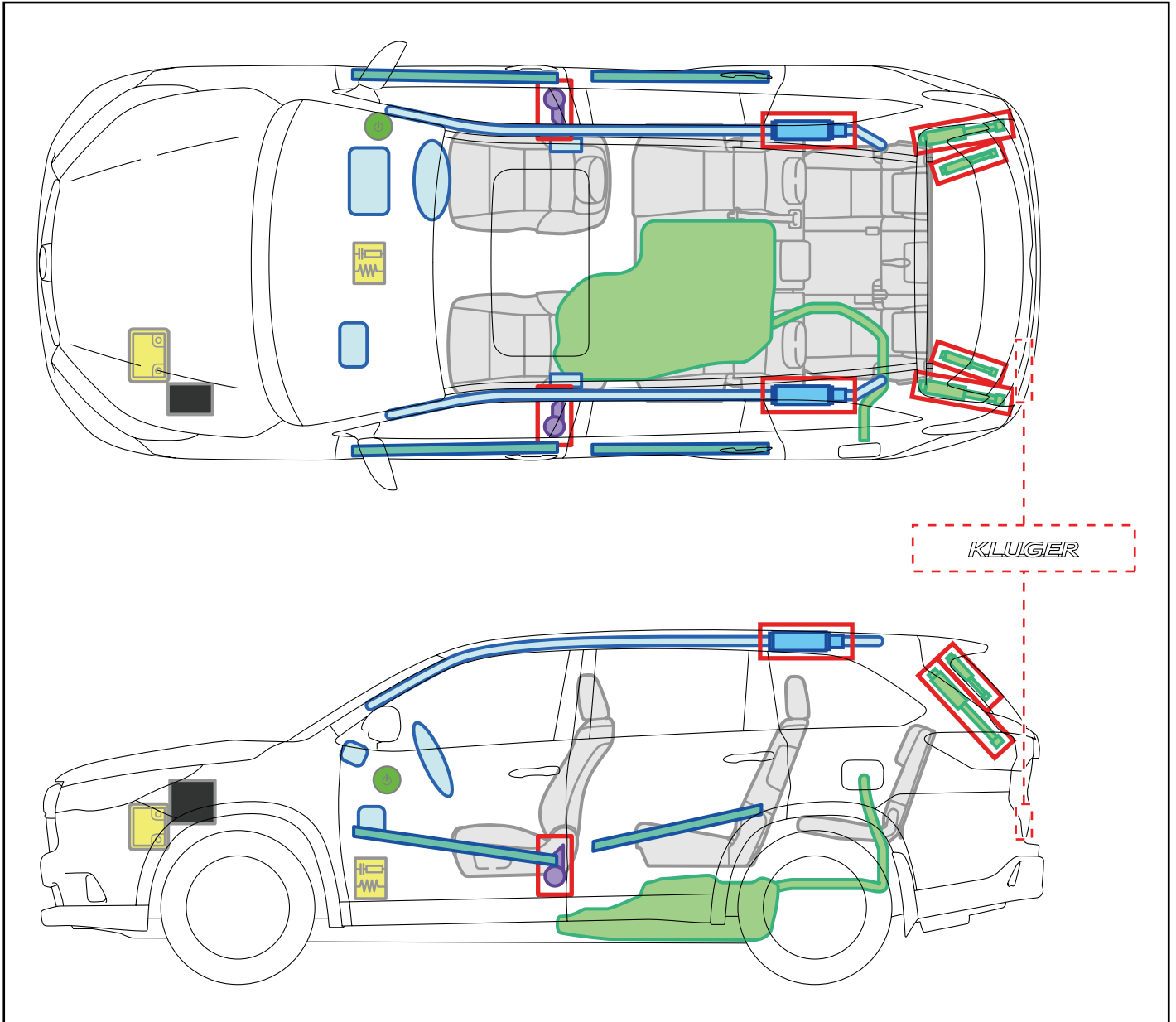
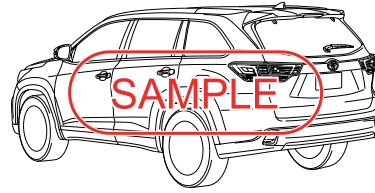
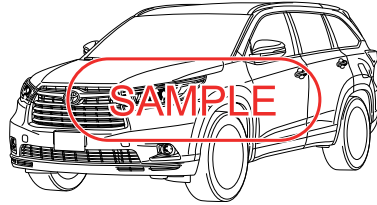

	IG/ENGINE SW		Fuse Box		12V Battery
	Airbag (incl. Inflator)		Inflator		Fuel Tank
	Gas-filled Damper		Seat Belt Pretensioner (Gas Generator)		Structural Reinforcements
	Airbag Computer	-	-	-	-
-	-	-	-	-	-

Disable Vehicle

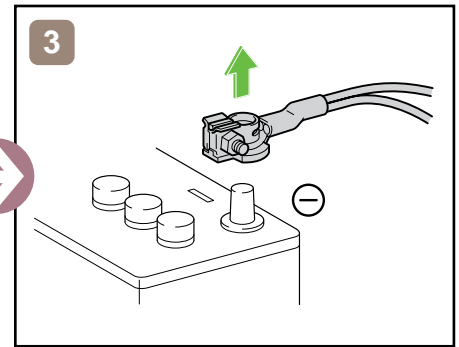
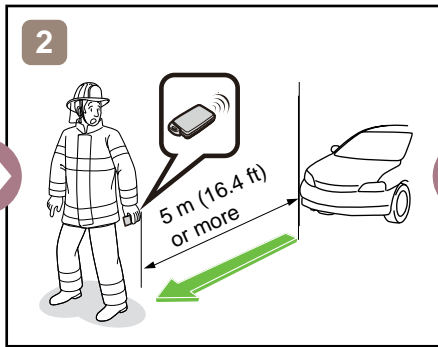
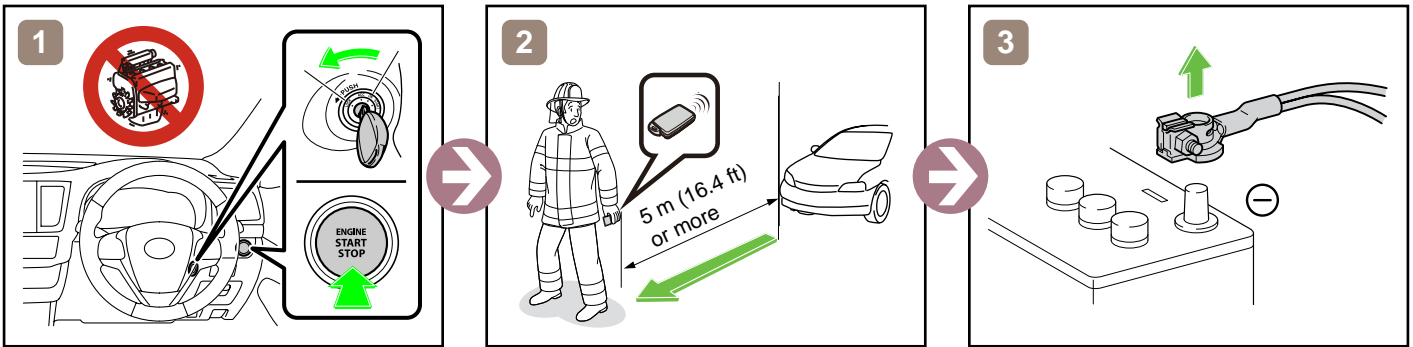

or

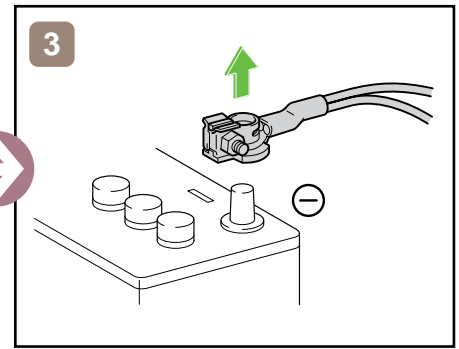
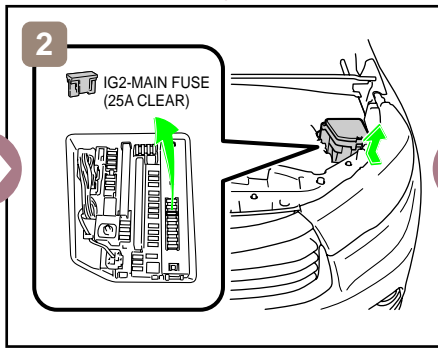
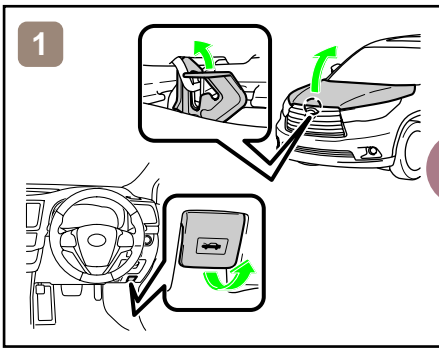

Access to 12V Battery

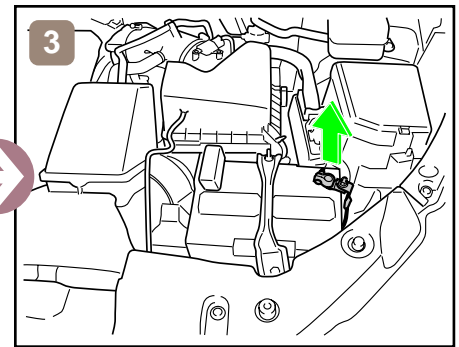
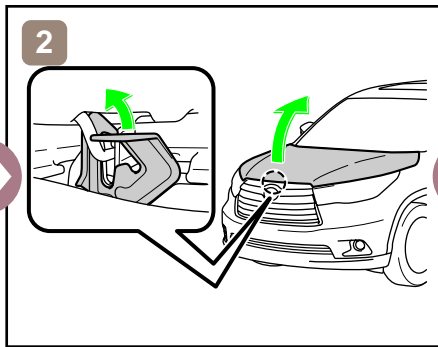
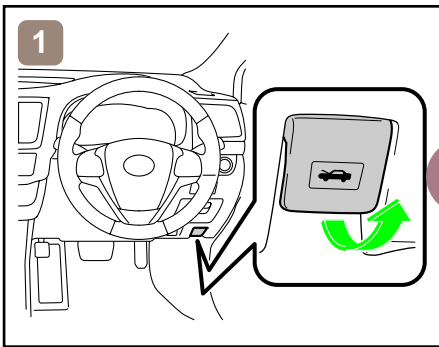

Towing Information

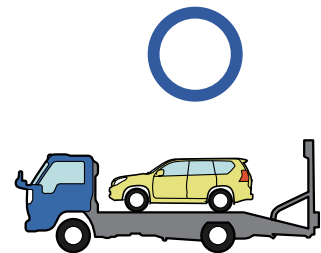
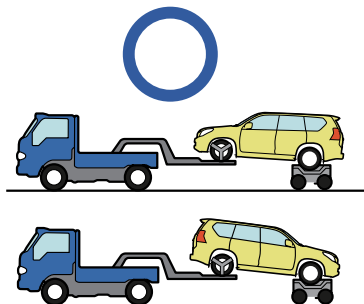
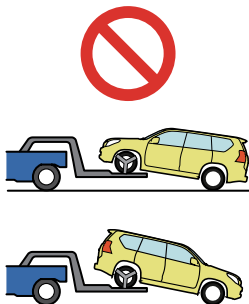

More details, please refer to "Emergency Response Guide".



TOYOTA HIGHLANDER/KLUGER

2020-10

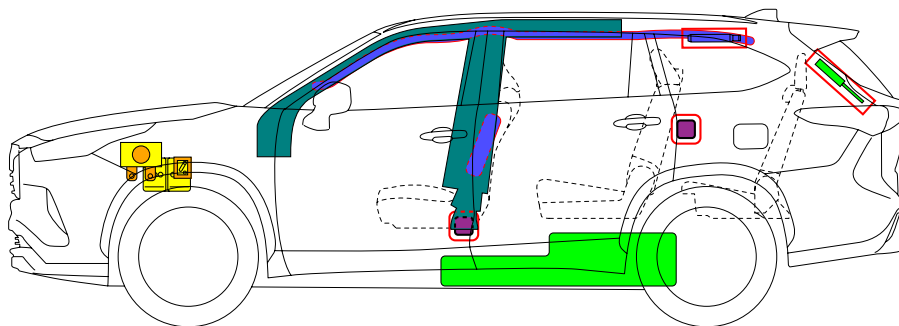
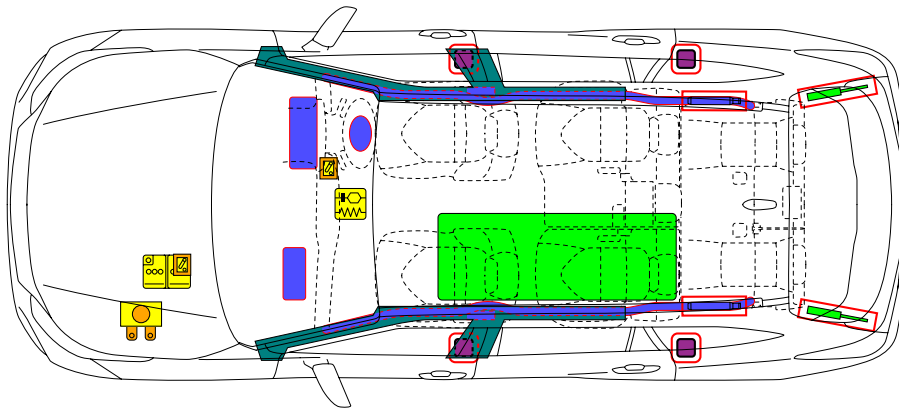

	Airbag		Stored gas inflator		Seat belt pretensioner		SRS control unit		Pedestrian protection active system
	Automatic rollover protection system		Gas strut / Preloaded spring		High strength zone		Zone requiring special attention		
	Battery low voltage		Ultra capacitor, low voltage		Fuel tank		Gas tank		Safety valve
	High voltage battery pack		High voltage power cable / component		High voltage disconnect		Fuse box disabling high voltage system		Ultra capacitor, high voltage
	Low voltage device that disconnects high voltage								
		ID No.		Version No.		Version date		Page	
		HIGHLANDER70		02		11 / 2023		1 / 4	

1. Identification / Recognition



Lack of engine noise does not mean vehicle is off. Silent movement or instant restart capability exists until vehicle is fully shut down.

■ Location of vehicle badges

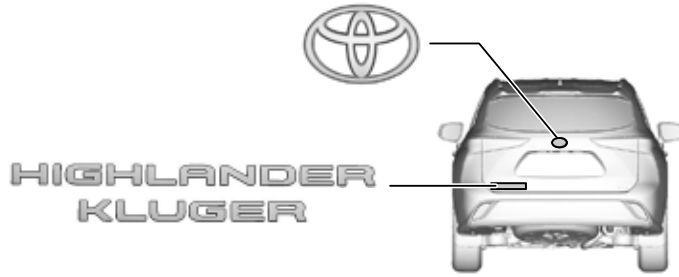

2. Immobilisation / Stabilisation / Lifting

■ Completely immobilize the vehicle

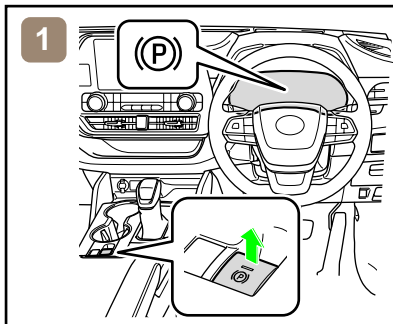

1. Chock the wheels and engage the parking brake.

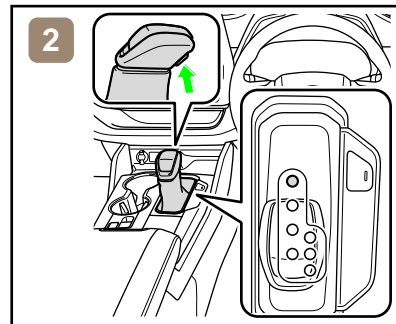

2. Move the shift lever to the park (P) position.

■ Stabilisation-lifting point

Place cribbing such as wooden blocks at the four points under the front and rear pillars.

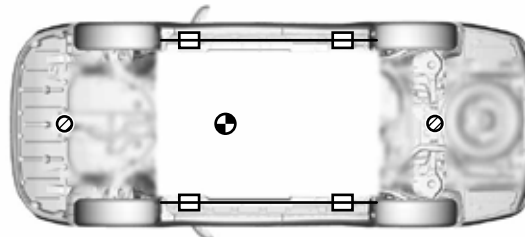

Extra Reinforced Lifting Points



Standard Jack Locations



Vehicle Center of Gravity



Do not place cribbing such as wooden blocks or rescue air lifting bags under the exhaust system or fuel system. Doing so may result in fuel leaks or fire.

3. Disable direct hazards / Safety regulations

■ If any of the following systems are required to be operated, operate them BEFORE disconnecting the battery.

Power door lock

Power window

Power back door

Moon roof

Power seat

Back door opener

Panoramic moon roof



When the 12 V battery is disconnected, electrical components cannot be operated.

ID No.	Version No.	Version date	Page
HIGHLANDER70	02	11 / 2023	2 / 4

■ Perform procedure Main or Alternative to completely shut off the vehicle.

<Procedure Main>

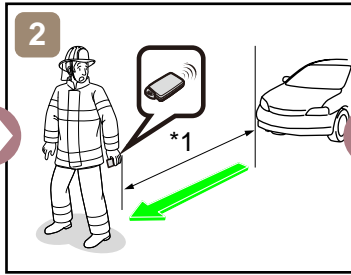
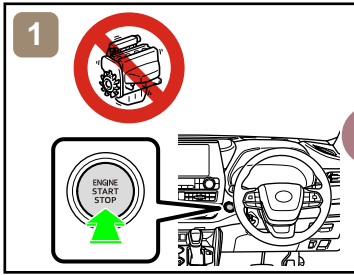
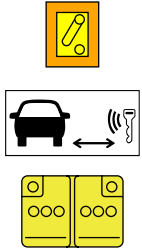

*1: 5 m (16.4 ft) or more

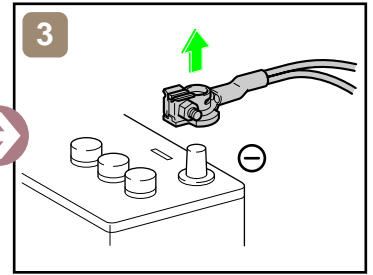

<Procedure Alternative>

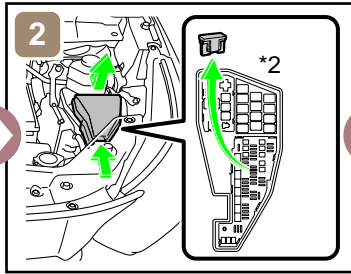
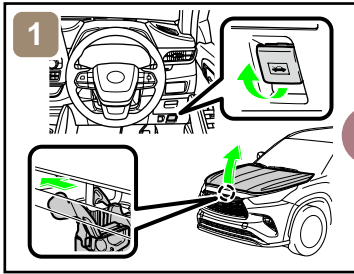
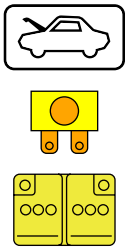

*2: IG2-MAIN FUSE (25 A CLEAR)
or
IGP-MAIN FUSE (30 A GREEN)

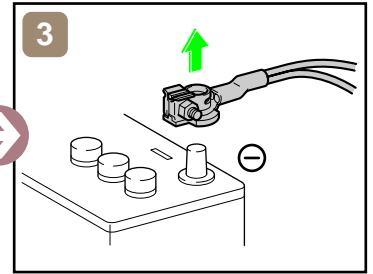

■ Access to 12 V Battery

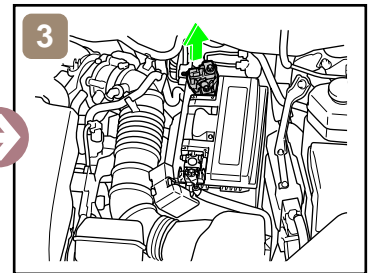
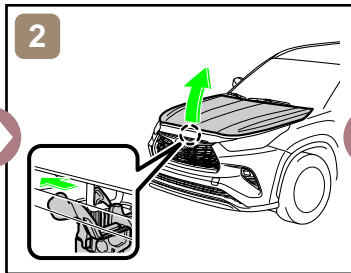
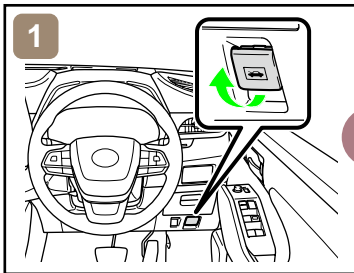
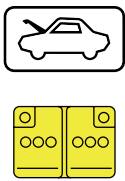

4. Access to the occupants

■ Window Glass

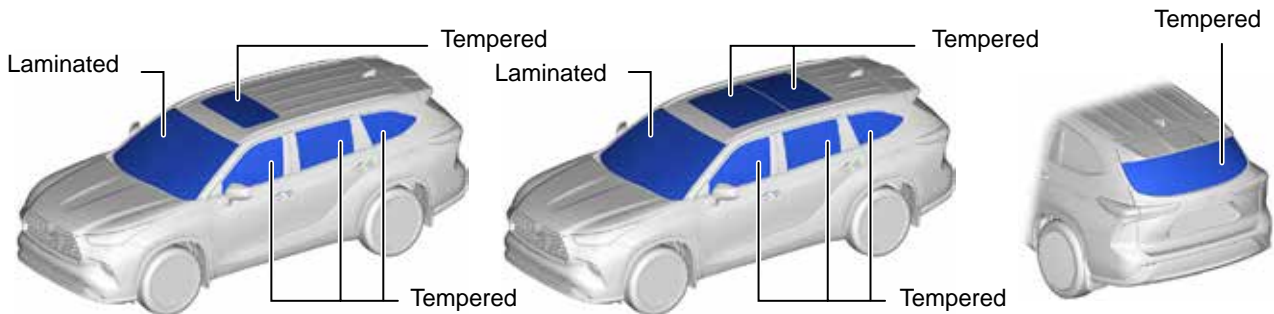

ID No.	Version No.	Version date	Page
HIGHLANDER70	02	11 / 2023	3 / 4

5. Stored energy / Liquids / Gases / Solids



12 V Battery



Gasoline Tank: 68 L



Always wear appropriate personal protective equipment (PPE) when dealing with any of these items.

6. In case of fire



RE-IGNITION POSSIBLE !

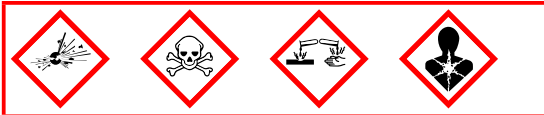

7. In case of submersion



Work on the vehicle only after the vehicle has been pulled out of the water.

8. Towing / Transportation / Storage

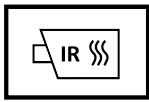
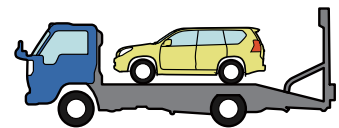

RE-IGNITION POSSIBLE !

Store the vehicle at a safe distance (15 m (49.2 ft) or more) from other vehicles.

9. Important additional information

For further details, please refer to "Emergency Response Guide".

	ID No.	Version No.	Version date	Page
	HIGHLANDER70	02	11 / 2023	4 / 4



**TOYOTA HIGHLANDER HYBRID/
KLUGER HYBRID**

2020-10

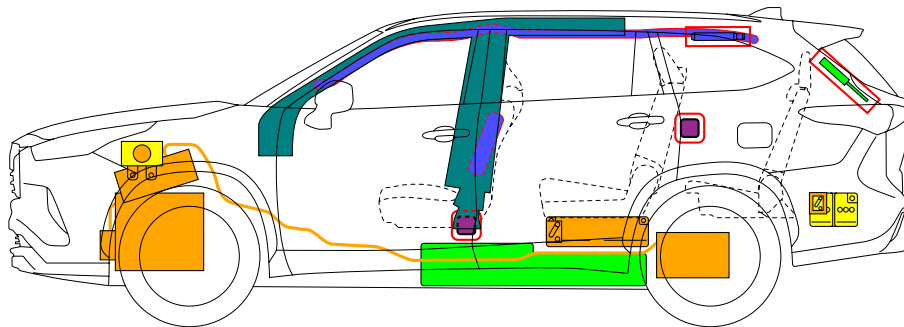
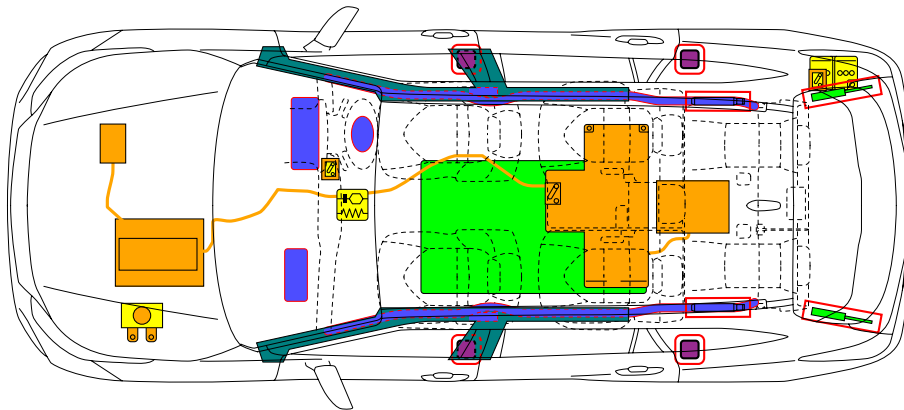
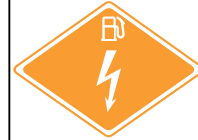

	Airbag		Stored gas inflator		Seat belt pretensioner		SRS control unit		Pedestrian protection active system
	Automatic rollover protection system		Gas strut / Preloaded spring		High strength zone		Zone requiring special attention		
	Battery low voltage		Ultra capacitor, low voltage		Fuel tank		Gas tank		Safety valve
	High voltage battery pack		High voltage power cable / component		High voltage disconnect		Fuse box disabling high voltage system		Ultra capacitor, high voltage
	Low voltage device that disconnects high voltage		High voltage component						
	ID No.	Version No.		Version date		Page			
	HIGHLANDERHV70	01		06 / 2021		1 / 4			

1. Identification / Recognition



Lack of engine noise does not mean vehicle is off. Silent movement or instant restart capability exists until vehicle is fully shut down.

■ Location of vehicle badges

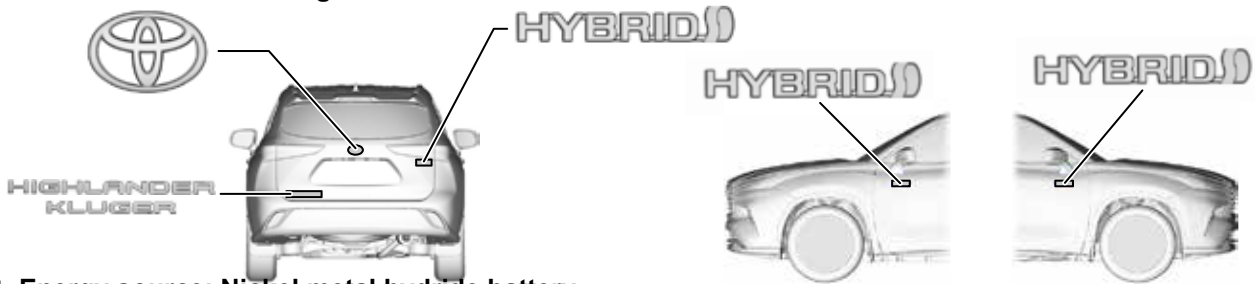

■ Energy source: Nickel metal hydride battery



2. Immobilisation / Stabilisation / Lifting

■ Completely immobilize the vehicle

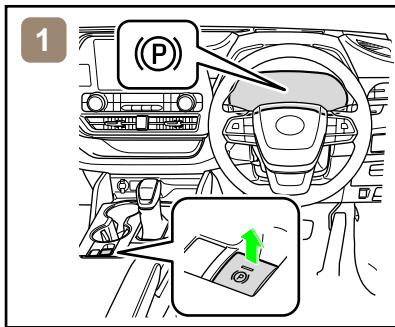

1. Chock the wheels and engage the parking brake.

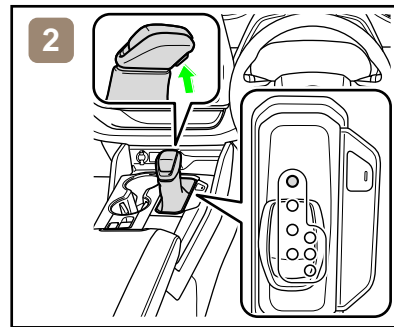

2. Move the shift lever to the park (P) position.

■ Stabilisation-lifting point

Place cribbing such as wooden blocks at the four points under the front and rear pillars.

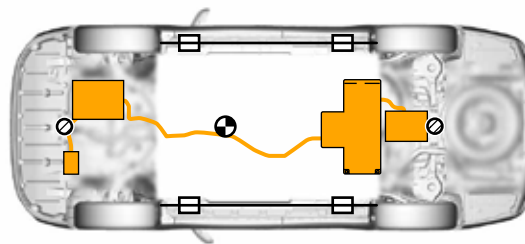

Extra Reinforced Lifting Points



Standard Jack Locations



Vehicle Center of Gravity



Do not place cribbing such as wooden blocks or rescue air lifting bags under the exhaust system, fuel system or high voltage power cables. Doing so may result in fuel leaks, fire, or electric shock.

3. Disable direct hazards / Safety regulations

■ If any of the following systems are required to be operated, operate them BEFORE disconnecting the battery.

Power door lock

Power window

Power back door

Moon roof

Power seat

Back door opener

Panoramic moon roof



When the 12 V battery is disconnected, electrical components cannot be operated.

ID No.	Version No.	Version date	Page
HIGHLANDERHV70	01	06 / 2021	2 / 4

■ Perform procedure Main or Alternative to completely shut off the vehicle.

<Procedure Main>

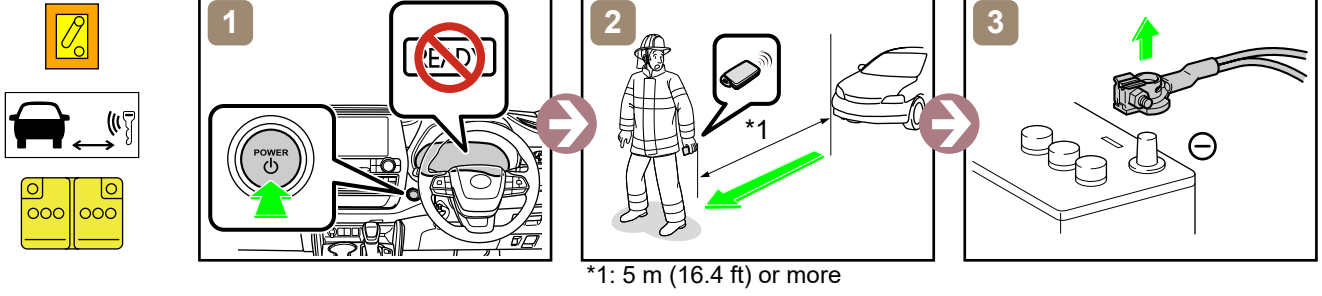

<Procedure Alternative>

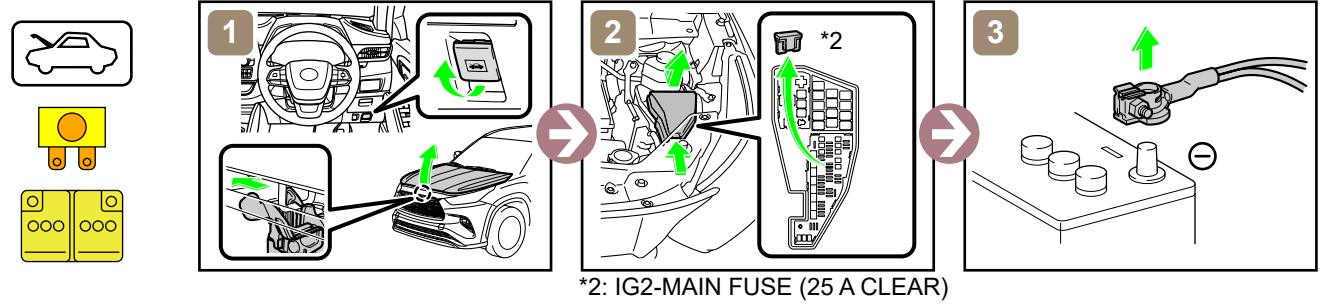

■ Access to 12 V Battery

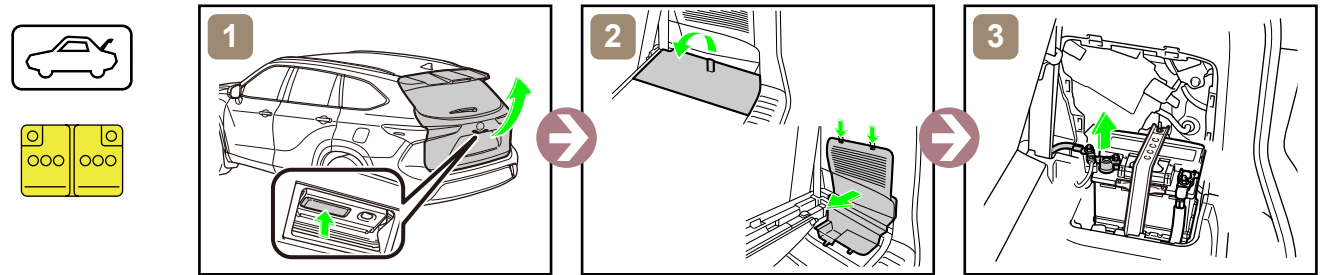

4. Access to the occupants

■ Window Glass

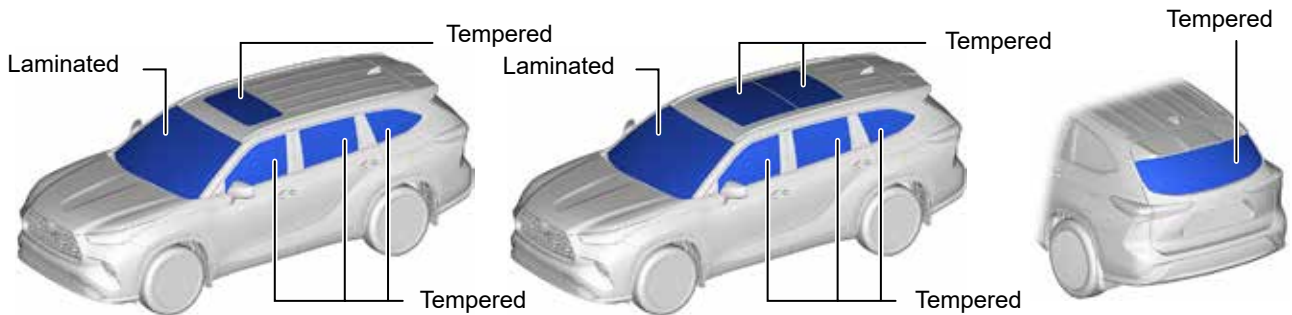

5. Stored energy / Liquids / Gases / Solids

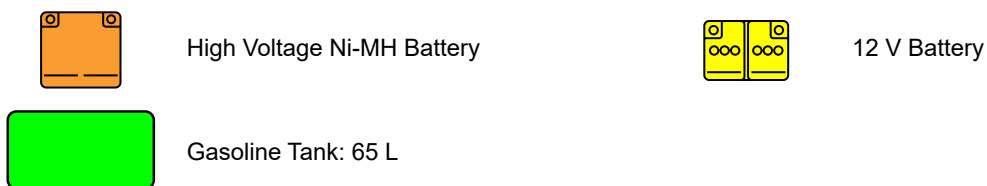

ID No.	Version No.	Version date	Page
HIGHLANDERHV70	01	06 / 2021	3 / 4



- Always wear appropriate personal protective equipment (PPE) when dealing with any of these items.
- Never breach or remove the battery assembly cover under any circumstances, including fire. Doing so may result in serious injury or death from severe burns or electric shock.

6. In case of fire



USE COPIOUS AMOUNTS OF WATER

If it is difficult to apply copious amounts of water to the high voltage battery, it is recommended to allow the high voltage battery to burn itself out.

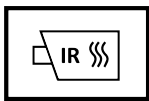

RE-IGNITION POSSIBLE !



7. In case of submersion



Do not touch any of the high-voltage components or cables, including the service plug, while the vehicle is submerged. Doing so may result in electric shock.
Work on the vehicle only after the vehicle has been pulled out of the water.

8. Towing / Transportation / Storage



RE-IGNITION POSSIBLE !

Store the vehicle at a safe distance (15 m (49.2 ft) or more) from other vehicles.

9. Important additional information

For further details, please refer to "Emergency Response Guide".

	ID No.	Version No.	Version date	Page
	HIGHLANDERHV70	01	06 / 2021	4 / 4



TOYOTA HIGHLANDER HYBRID/
KLUGER HYBRID
2023-11

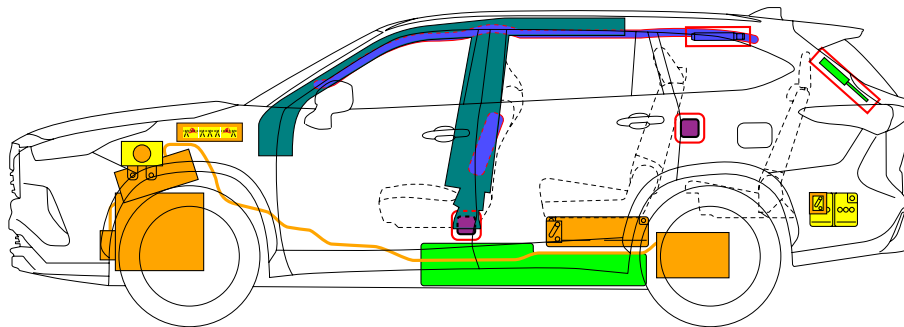
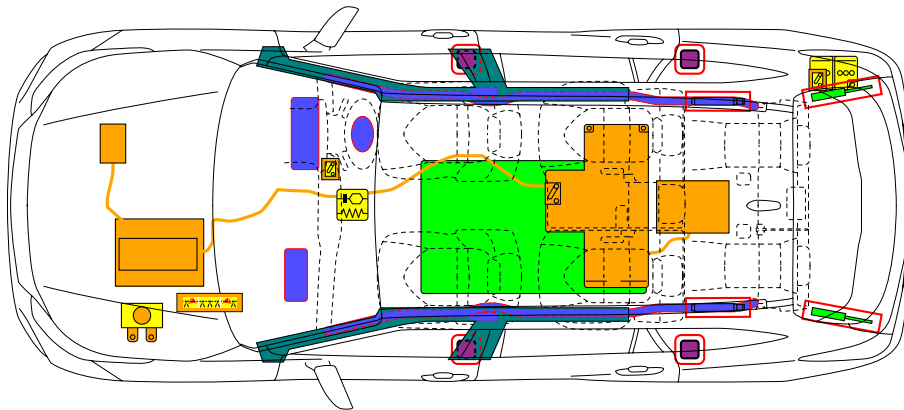

	Airbag		Stored gas inflator		Seat belt pretensioner		SRS control unit		Pedestrian protection active system
	Automatic rollover protection system		Gas strut / Preloaded spring		High strength zone		Zone requiring special attention		
	Battery low voltage		Ultra capacitor, low voltage		Fuel tank		Gas tank		Safety valve
	High voltage battery pack		High voltage power cable / component		High voltage disconnect		Fuse box disabling high voltage system		Ultra capacitor, high voltage
	Low voltage device that disconnects high voltage		Cable cut		High voltage component				
ID No.		Version No.		Version date		Page			
HIGHLANDERHV70		02		11 / 2023		1 / 4			

1. Identification / Recognition



Lack of engine noise does not mean vehicle is off. Silent movement or instant restart capability exists until vehicle is fully shut down.

Location of vehicle badges

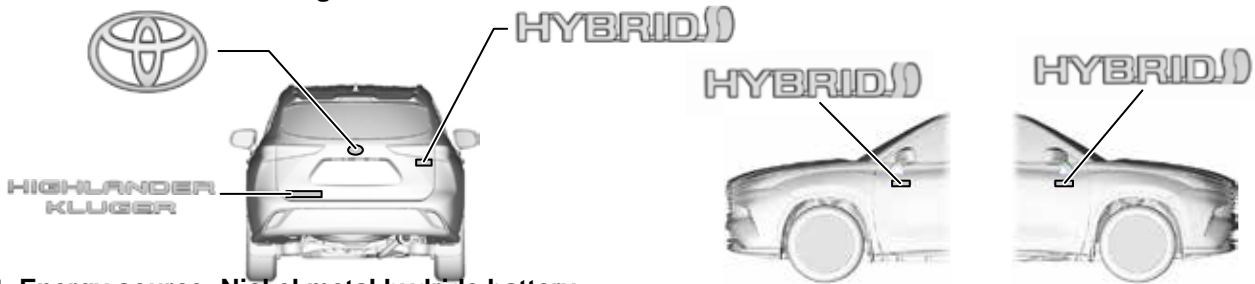

Energy source: Nickel metal hydride battery



2. Immobilisation / Stabilisation / Lifting

Completely immobilize the vehicle

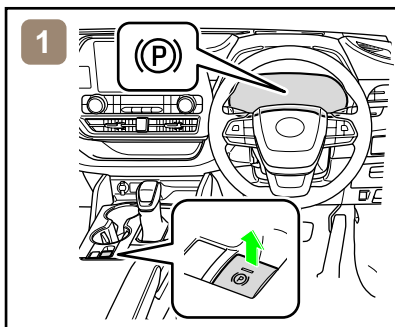

1. Chock the wheels and engage the parking brake.

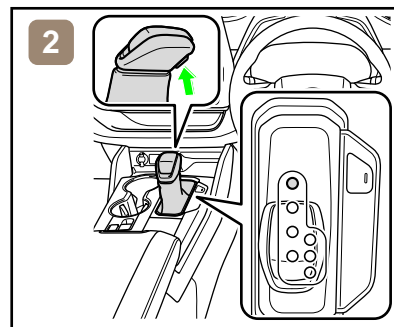

2. Move the shift lever to the park (P) position.

Stabilisation-lifting point

Place cribbing such as wooden blocks at the four points under the front and rear pillars.

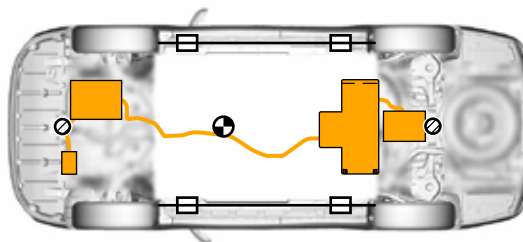

Extra Reinforced Lifting Points



Standard Jack Locations



Vehicle Center of Gravity



Do not place cribbing such as wooden blocks or rescue air lifting bags under the exhaust system, fuel system or high voltage power cables. Doing so may result in fuel leaks, fire, or electric shock.

3. Disable direct hazards / Safety regulations

If any of the following systems are required to be operated, operate them BEFORE disconnecting the battery.

Power door lock

Power window

Power back door

Moon roof

Power seat

Back door opener

Panoramic moon roof



When the 12 V battery is disconnected, electrical components cannot be operated.

ID No.	Version No.	Version date	Page
HIGHLANDERHV70	02	11 / 2023	2 / 4

■ Perform procedure Main or Alternative to completely shut off the vehicle.

<Procedure Main>

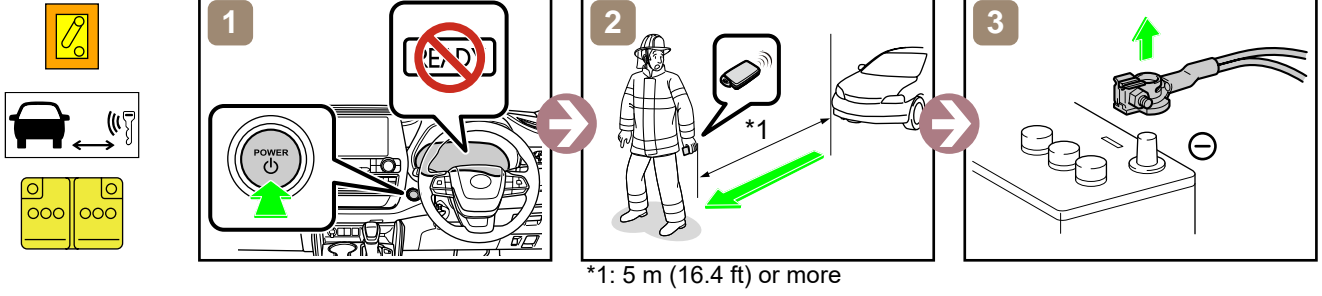

<Procedure Alternative>

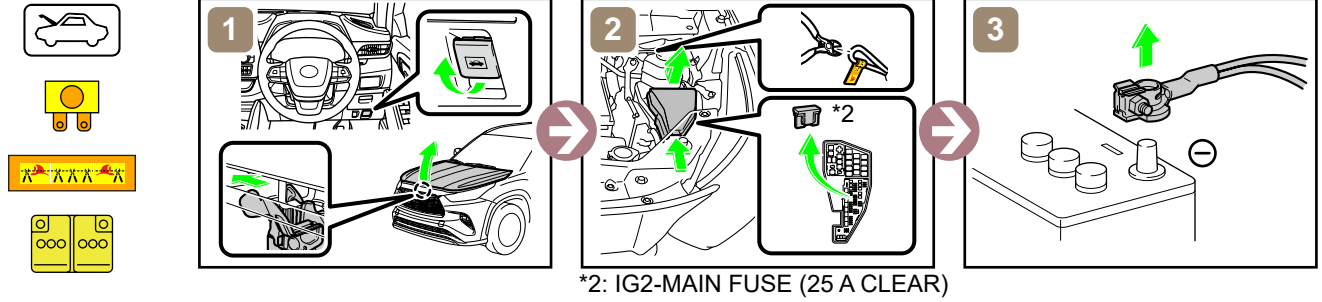

■ Access to 12 V Battery

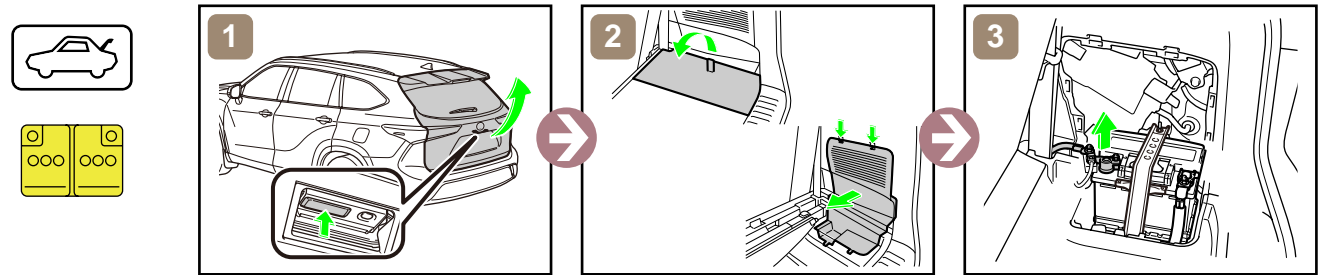

4. Access to the occupants

■ Window Glass

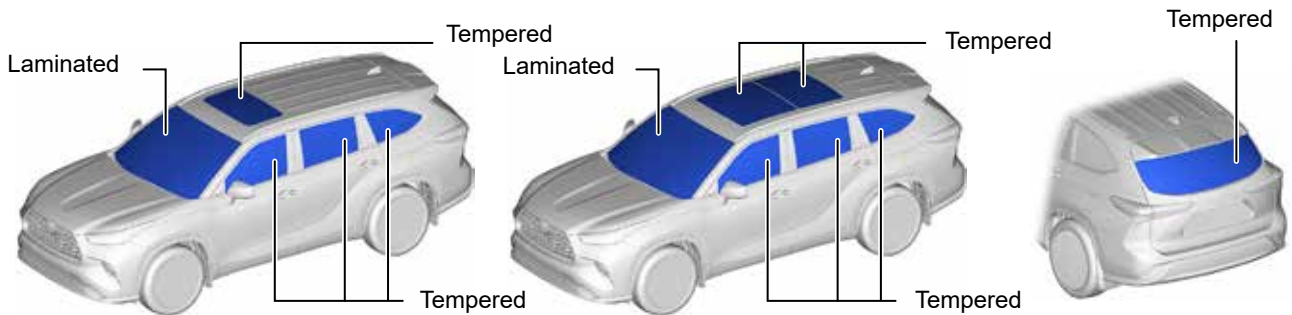

5. Stored energy / Liquids / Gases / Solids

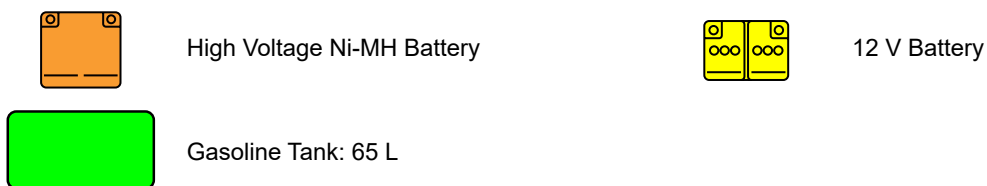

ID No.	Version No.	Version date	Page
HIGHLANDERHV70	02	11 / 2023	3 / 4



- Always wear appropriate personal protective equipment (PPE) when dealing with any of these items.
- Never breach or remove the battery assembly cover under any circumstances, including fire. Doing so may result in serious injury or death from severe burns or electric shock.

6. In case of fire



USE COPIOUS AMOUNTS OF WATER

If it is difficult to apply copious amounts of water to the high voltage battery, it is recommended to allow the high voltage battery to burn itself out.

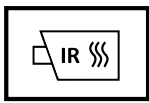

RE-IGNITION POSSIBLE !



7. In case of submersion



Do not touch any of the high-voltage components or cables, including the service plug, while the vehicle is submerged. Doing so may result in electric shock.
Work on the vehicle only after the vehicle has been pulled out of the water.

8. Towing / Transportation / Storage



RE-IGNITION POSSIBLE !

Store the vehicle at a safe distance (15 m (49.2 ft) or more) from other vehicles.

9. Important additional information





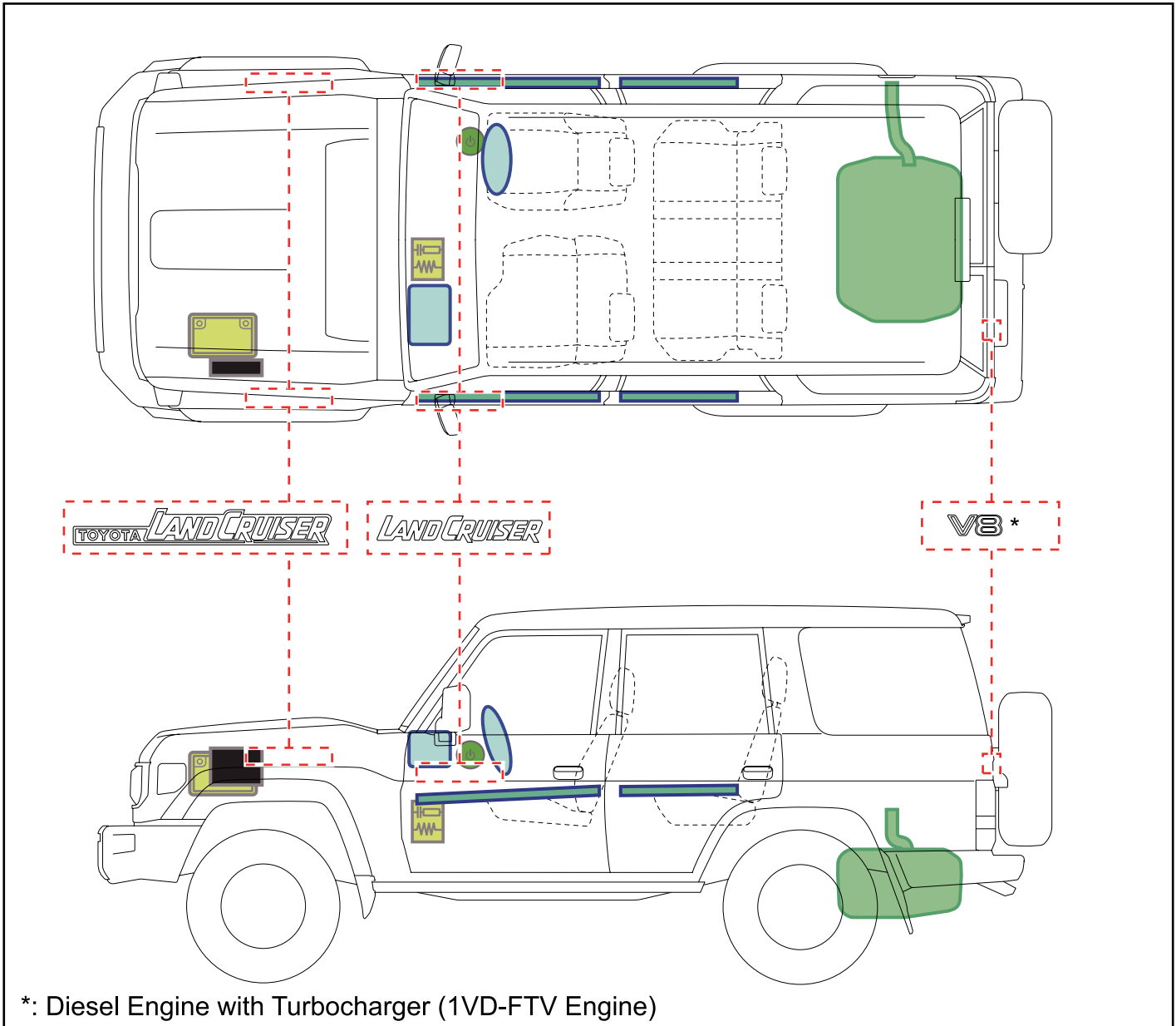

For further details, please refer to "Emergency Response Guide".

ID No.	Version No.	Version date	Page
HIGHLANDERHV70	02	11 / 2023	4 / 4

LAND
CRUISER
VAN / 5 DOOR
/ RHD
2014-8



*: Diesel Engine with Turbocharger (1VD-FTV Engine)

	IG/POWER SW		Fuse Box		12V Battery
	Airbag (incl. Inflator)		Fuel Tank		Structural Reinforcements
	Airbag Computer	—	—	—	—
—	—	—	—	—	—
—	—	—	—	—	—

Disable Vehicle

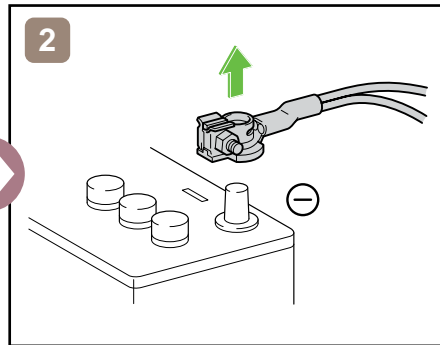
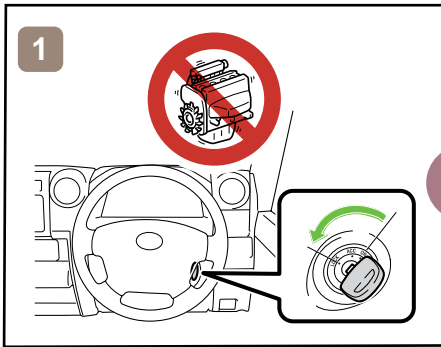

This method is not available for a 1HZ engine.

or

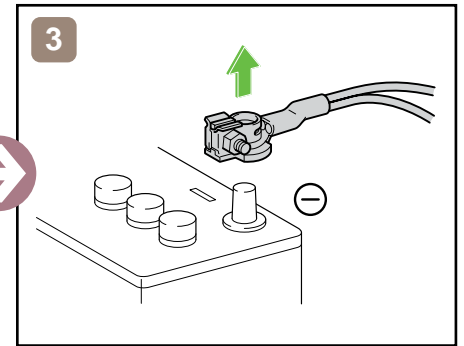
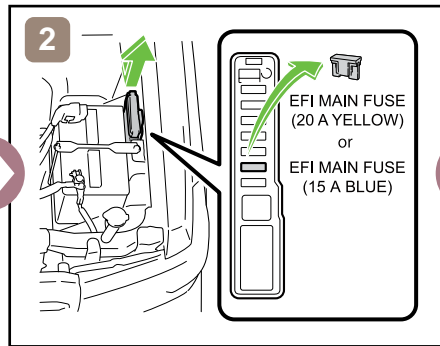
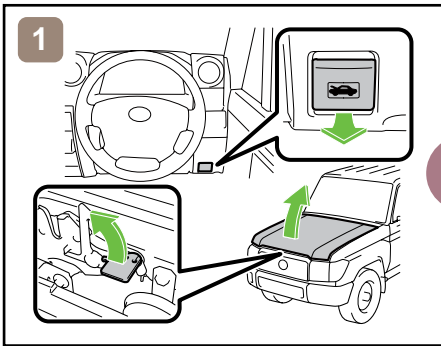

Access to 12V Battery

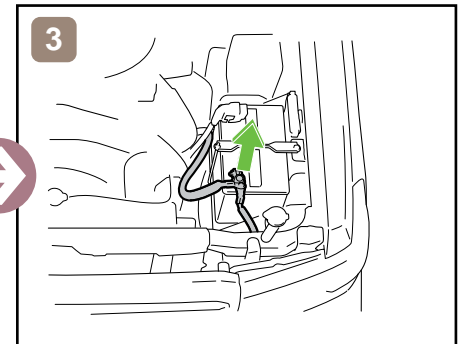
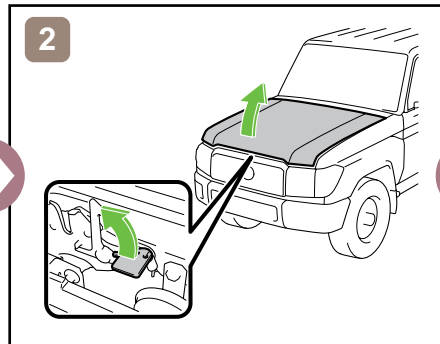
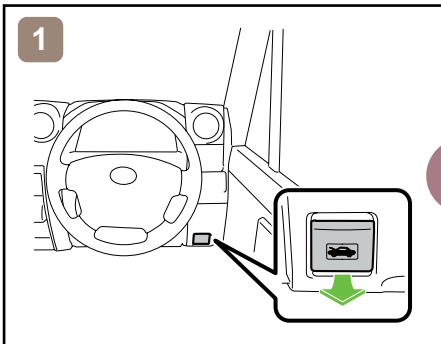



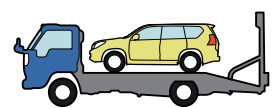



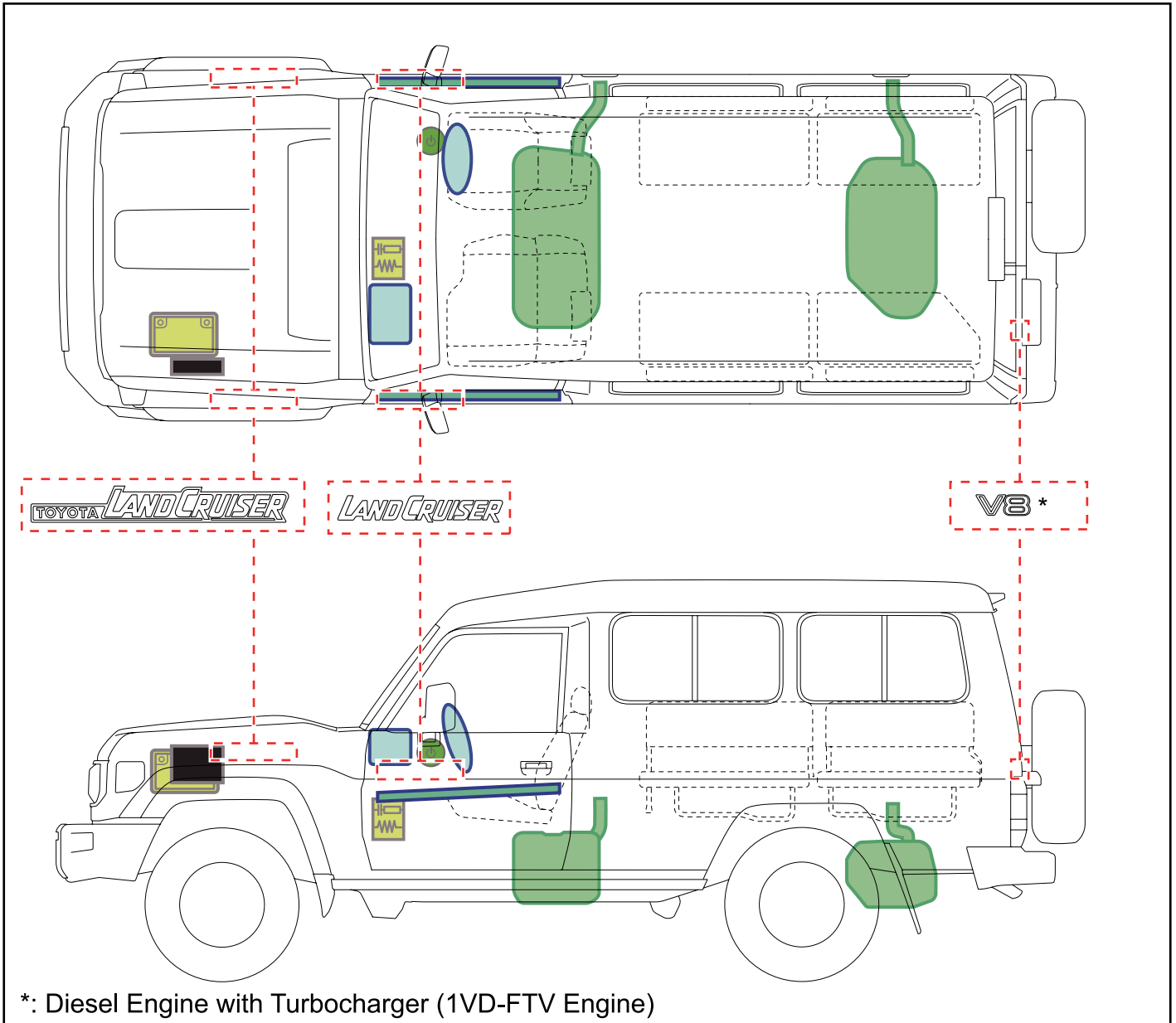
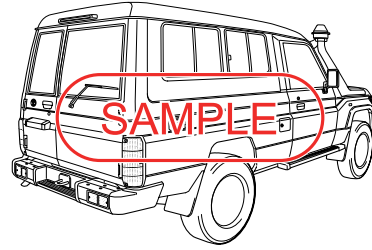
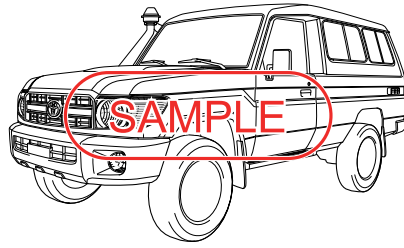

Towing Information



More details, please refer to "Emergency Response Guide".

LAND
CRUISER
VAN / 3 DOOR
/ LONG / RHD
2014-8



	IG/POWER SW		Fuse Box		12V Battery
	Airbag (incl. Inflator)		Fuel Tank		Structural Reinforcements
	Airbag Computer	—	—	—	—
—	—	—	—	—	—
—	—	—	—	—	—

Disable Vehicle

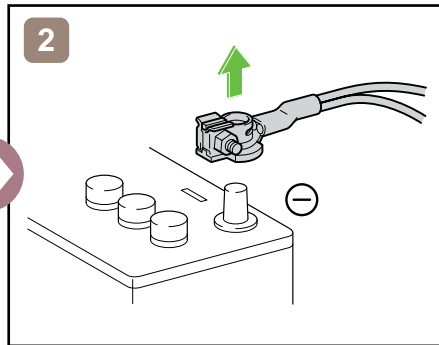
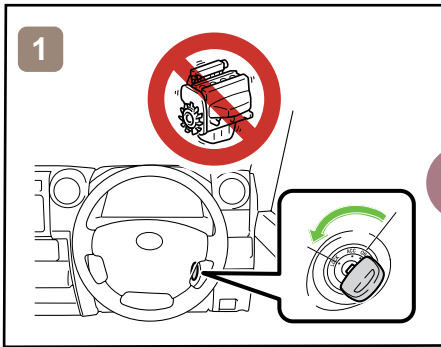

This method is not available for a 1HZ engine.

or

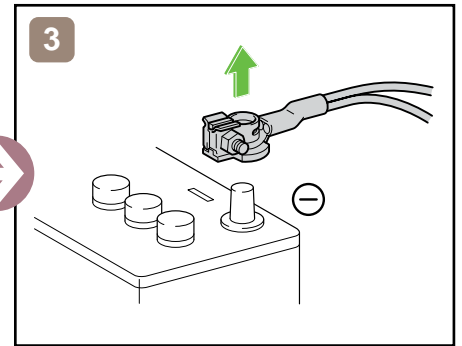
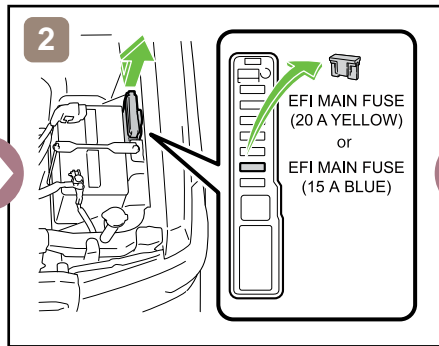
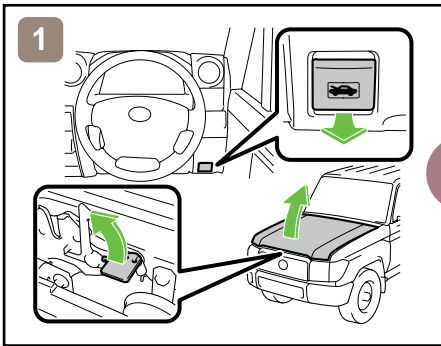

Access to 12V Battery

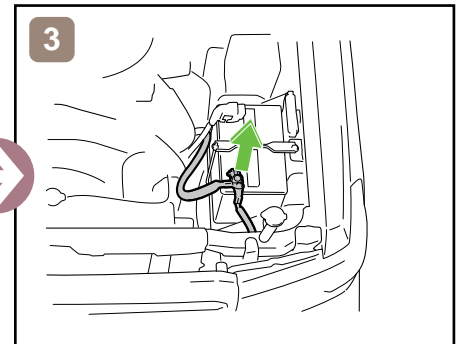
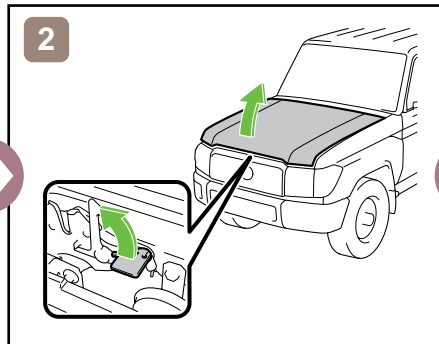
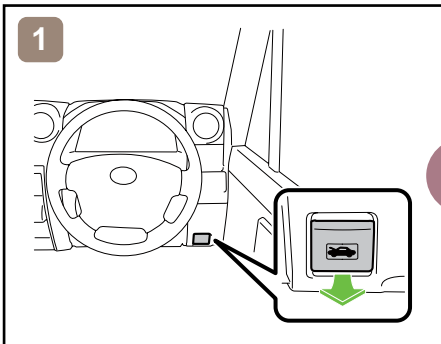

Towing Information

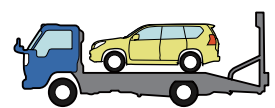

More details, please refer to "Emergency Response Guide".

LAND
CRUISER
PICKUP / 4 DOOR
/ RHD
2014-8

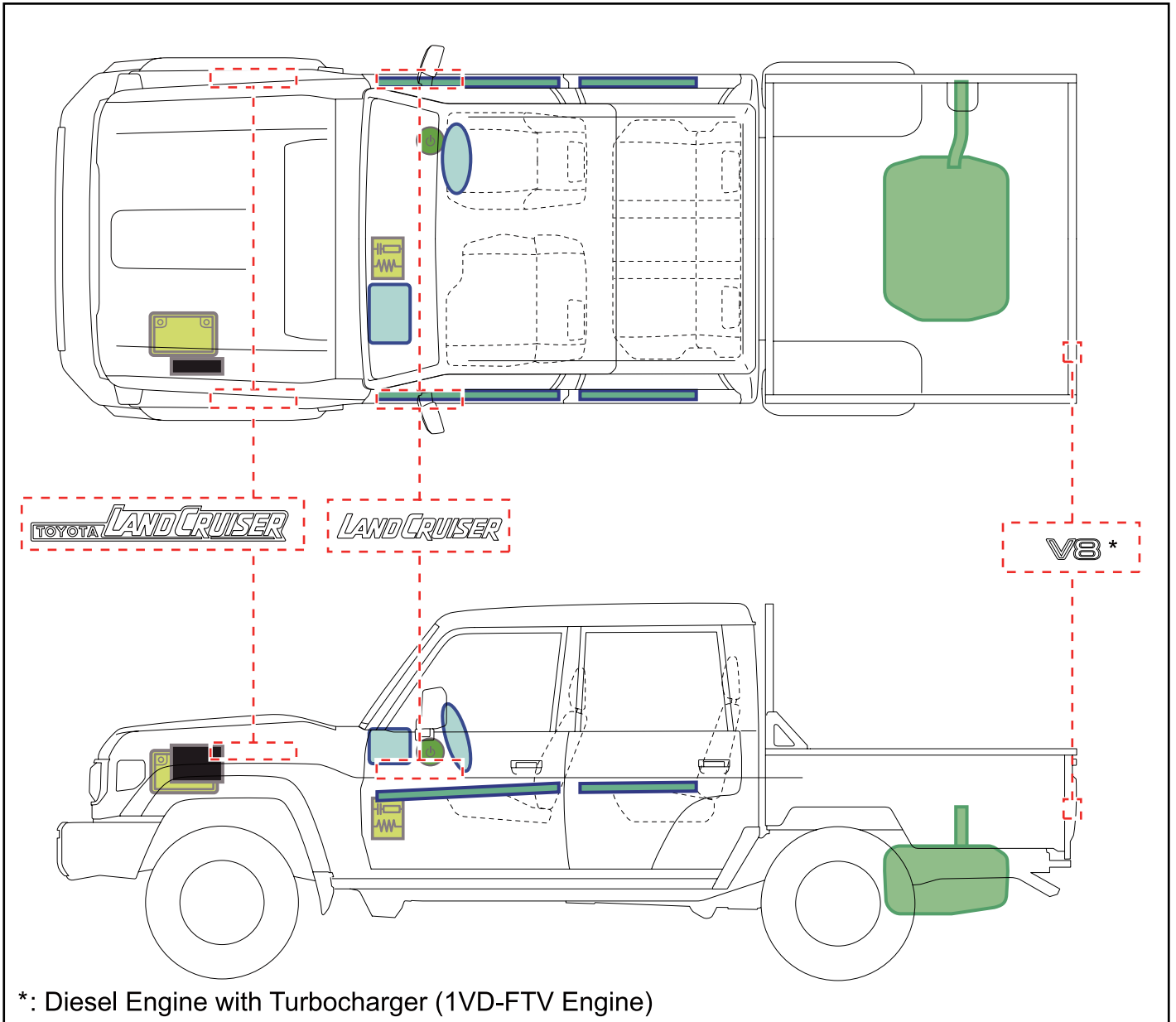

*: Diesel Engine with Turbocharger (1VD-FTV Engine)

	IG/POWER SW		Fuse Box		12V Battery
	Airbag (incl. Inflator)		Fuel Tank		Structural Reinforcements
	Airbag Computer	—	—	—	—
—	—	—	—	—	—
—	—	—	—	—	—

Disable Vehicle

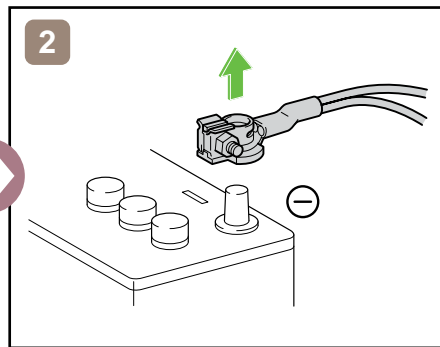
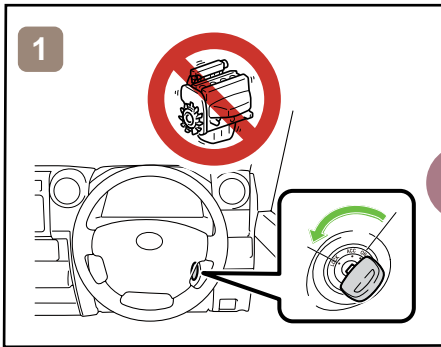

This method is not available for a 1HZ engine.

or

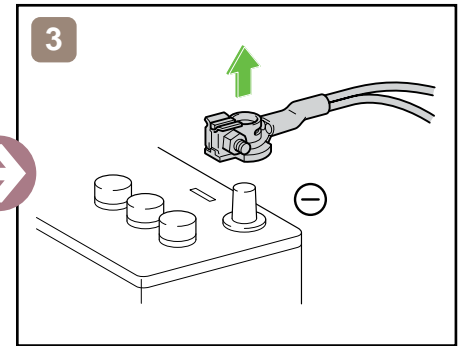
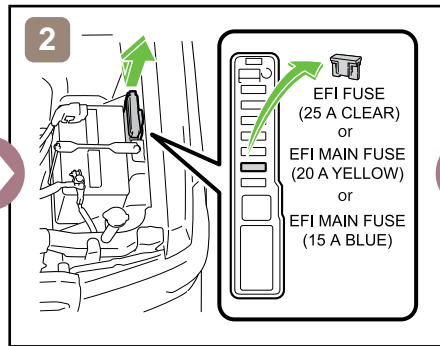
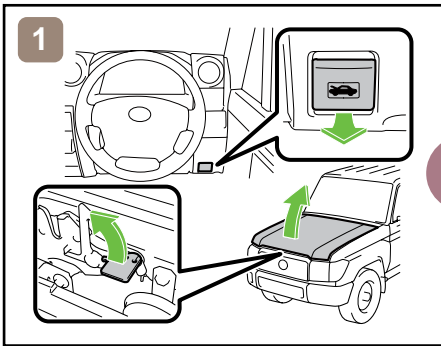

Access to 12V Battery

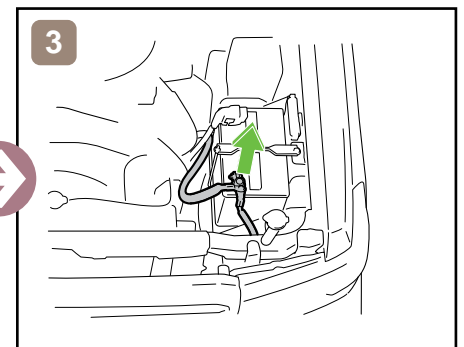
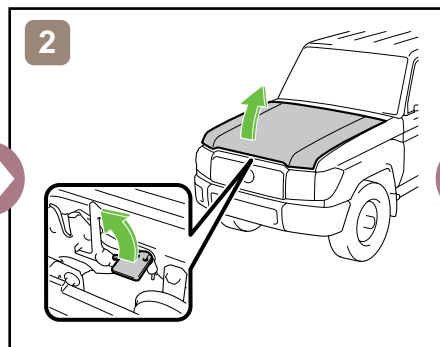
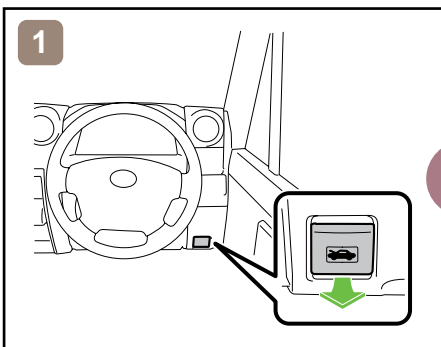

Towing Information



More details, please refer to "Emergency Response Guide".

LAND
CRUISER
PICKUP / 2 DOOR
/ RHD
2014-8

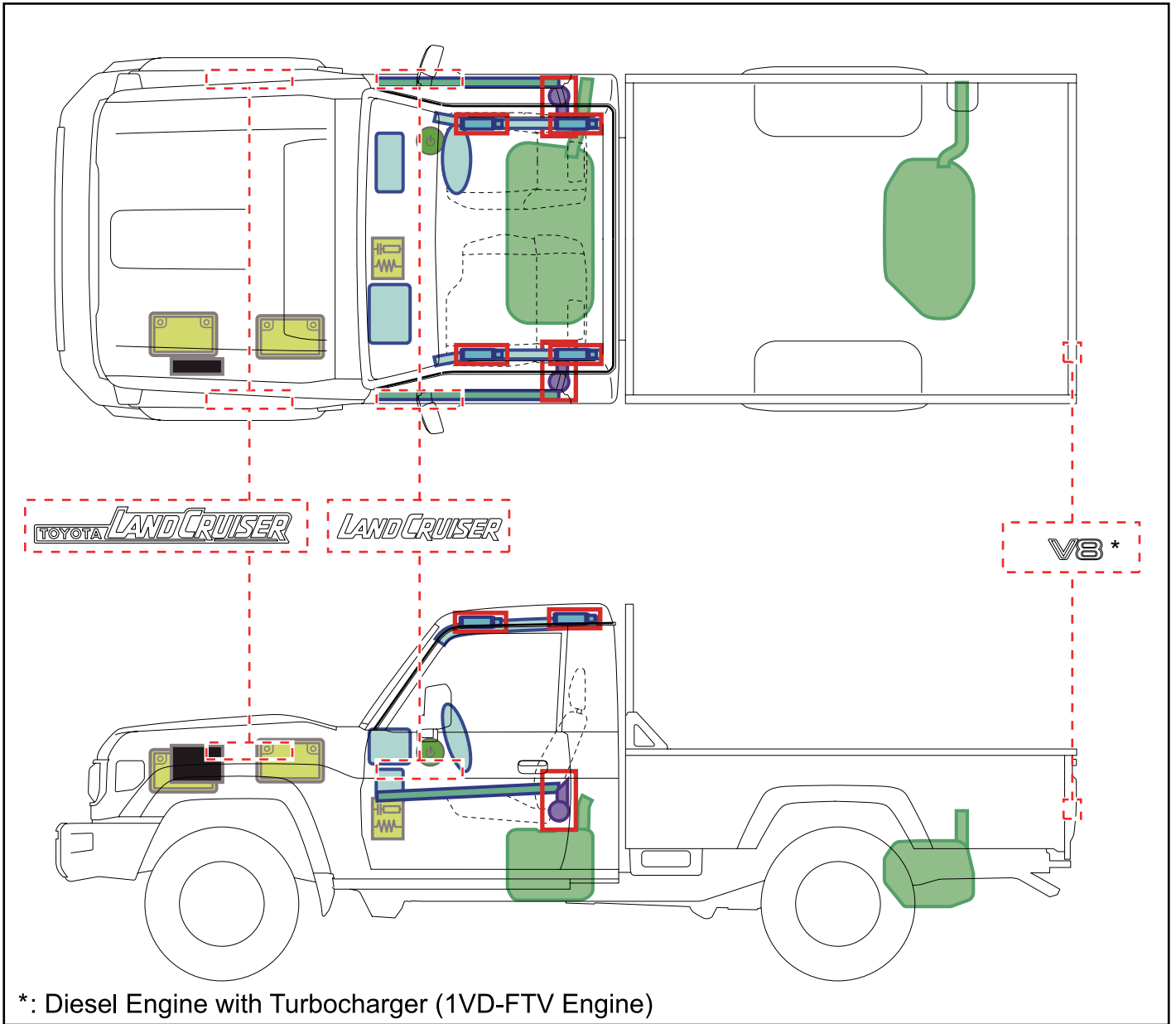
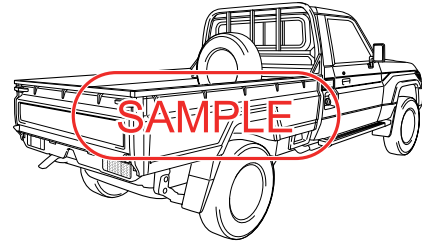
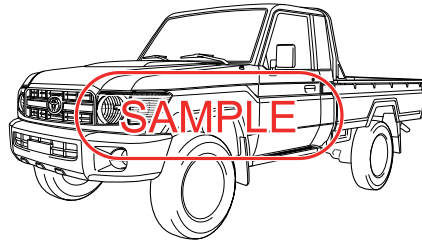

*: Diesel Engine with Turbocharger (1VD-FTV Engine)

	IG/POWER SW		Fuse Box		12V Battery
	Airbag (incl. Inflator)		Fuel Tank		Structural Reinforcements
	Airbag Computer		Inflator		Seat Belt Pretensioner (Gas Generator)
—	—	—	—	—	—
—	—	—	—	—	—

Disable Vehicle

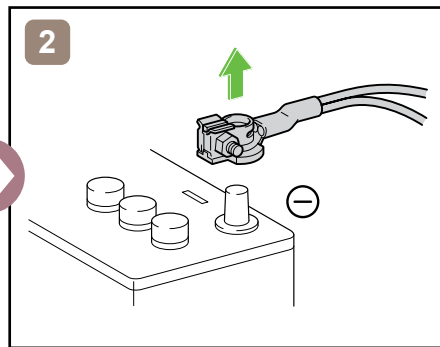
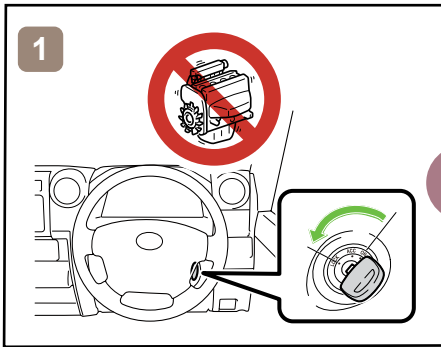

This method is not available for a 1HZ engine.

or

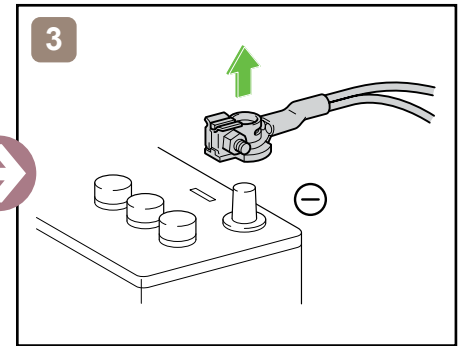
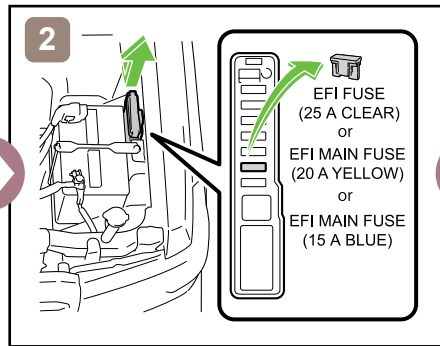
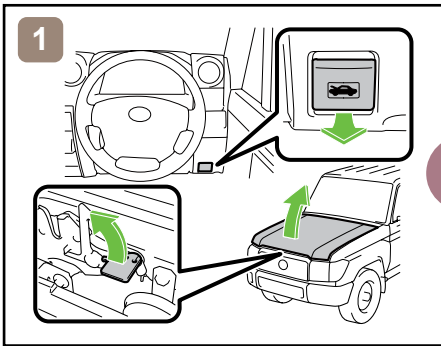

Access to 12V Battery

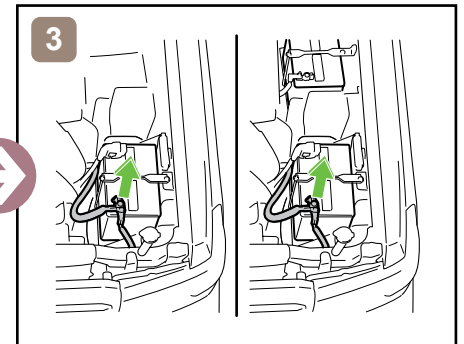
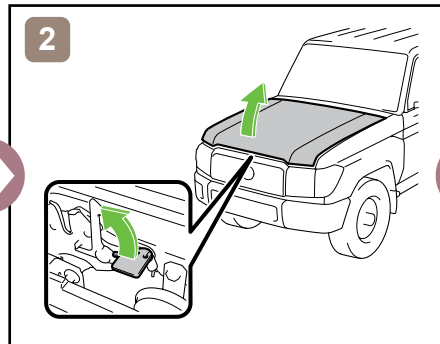
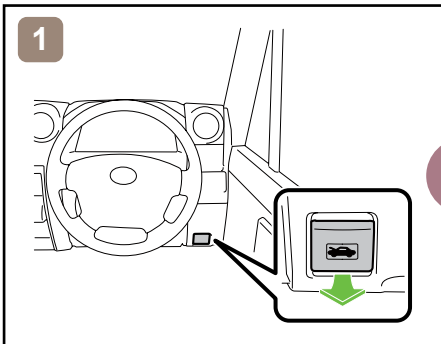

Towing Information

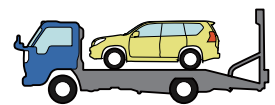

More details, please refer to "Emergency Response Guide".







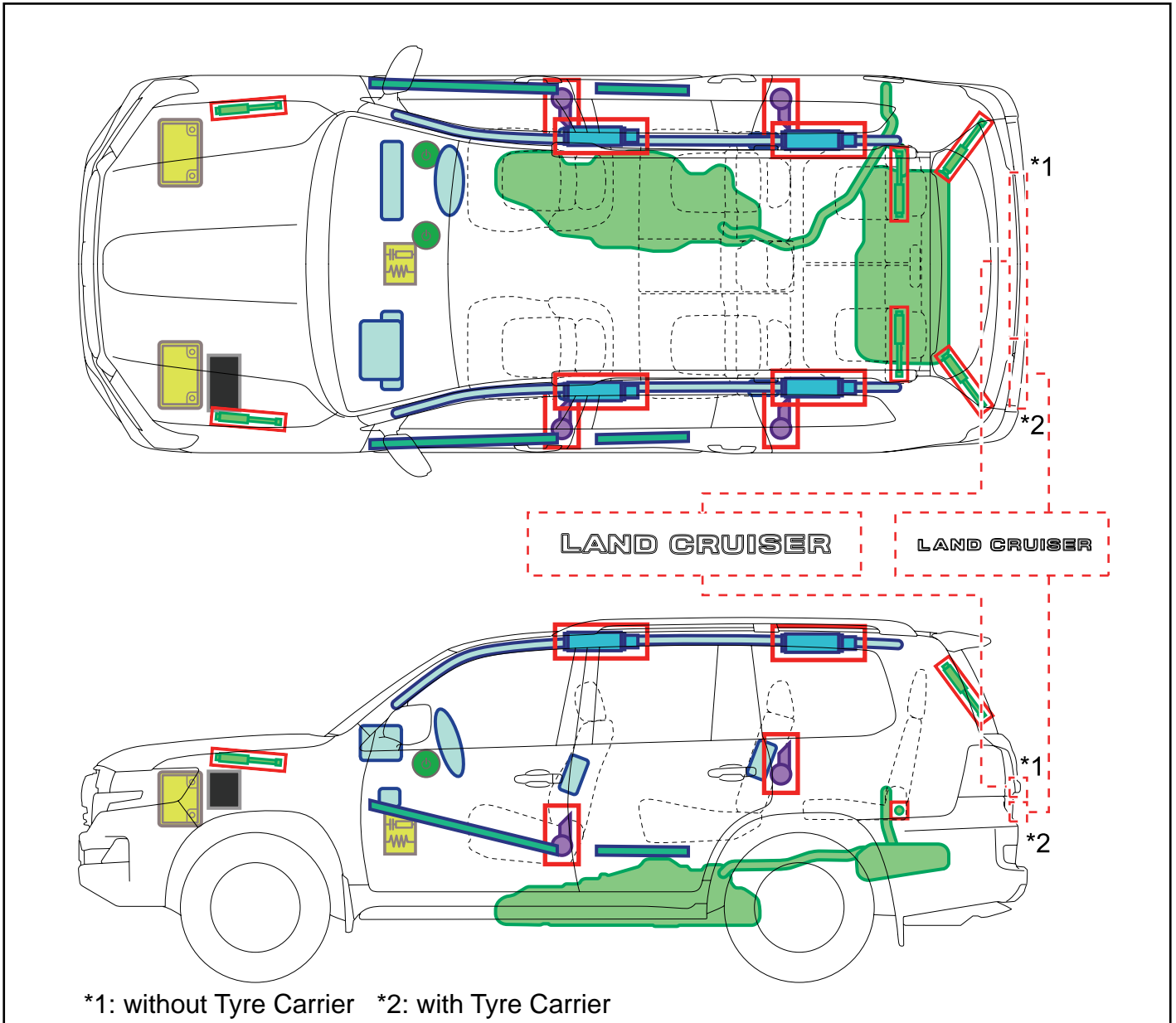
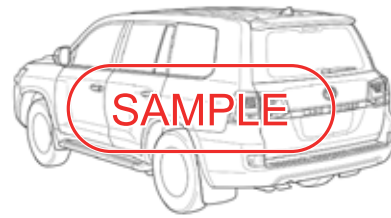
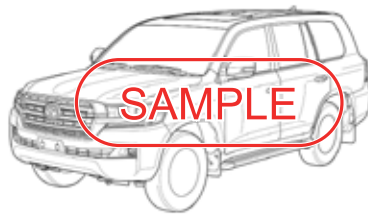



LAND CRUISER

200

2015-8



*1: without Tyre Carrier *2: with Tyre Carrier

	IG/ENGINE SW		Fuse Box		12V Battery
	Airbag (incl. Inflator)		Inflator		Fuel Tank
	Gas-filled Damper		Seat Belt Pretensioner (Gas Generator)		Structural Reinforcements
	Airbag Computer	—	—	—	—
—	—	—	—	—	—

Disable Vehicle

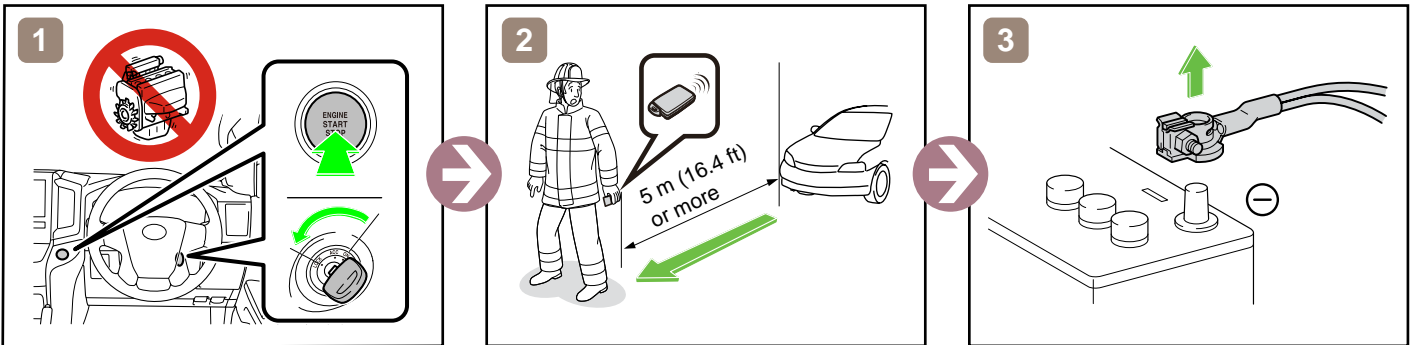

or

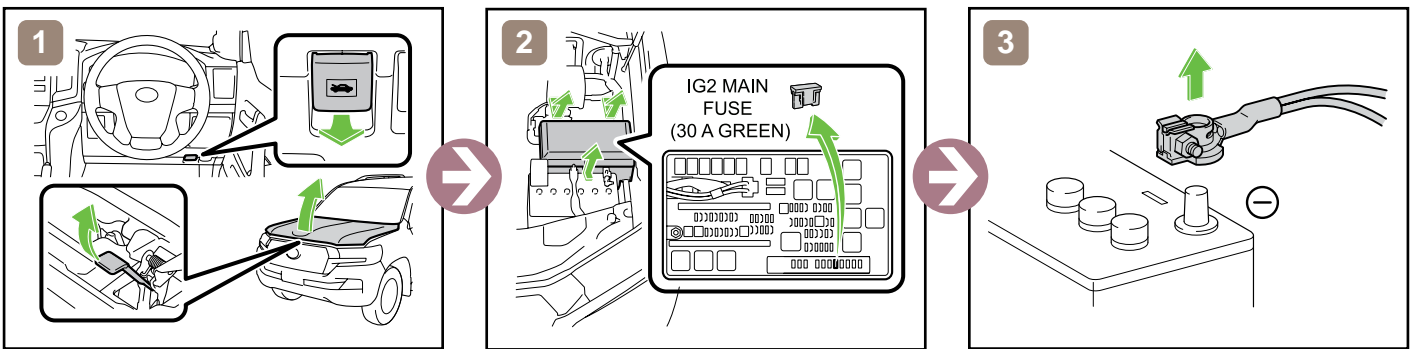

Access to 12V Battery

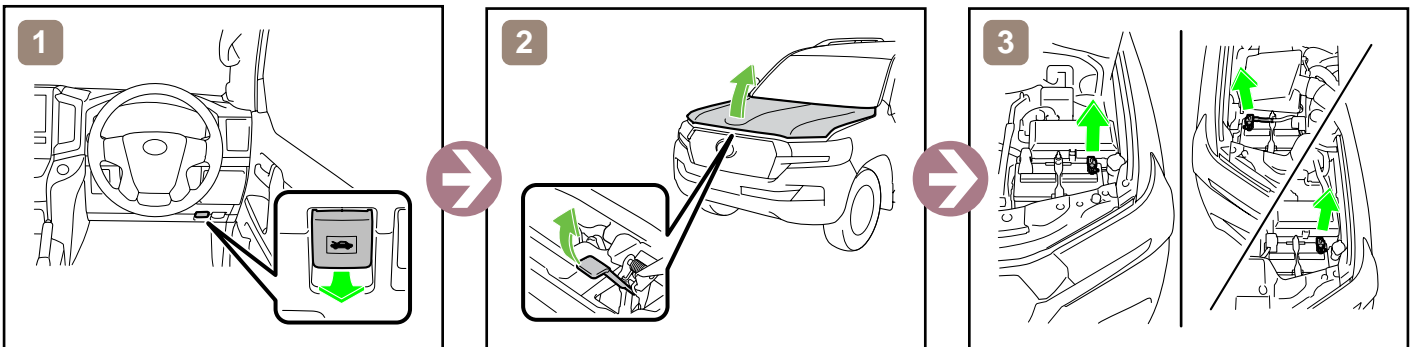

Towing Information

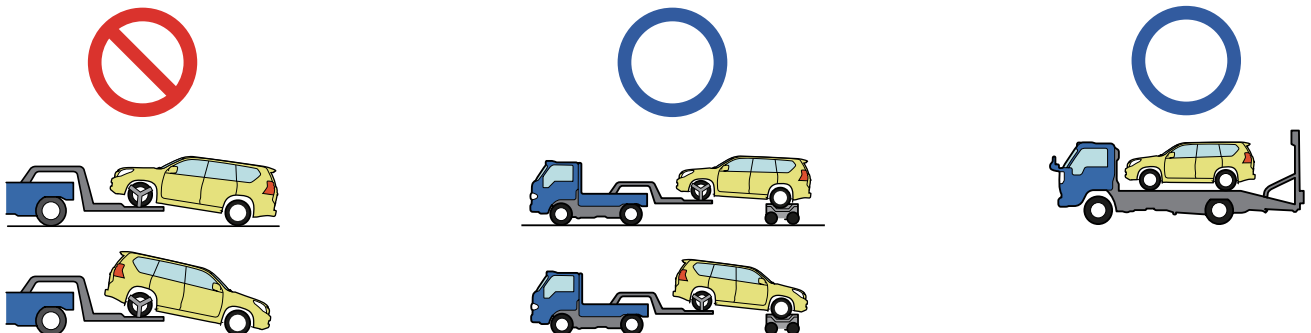

More details, please refer to "Emergency Response Guide".



TOYOTA LAND CRUISER

2021-7

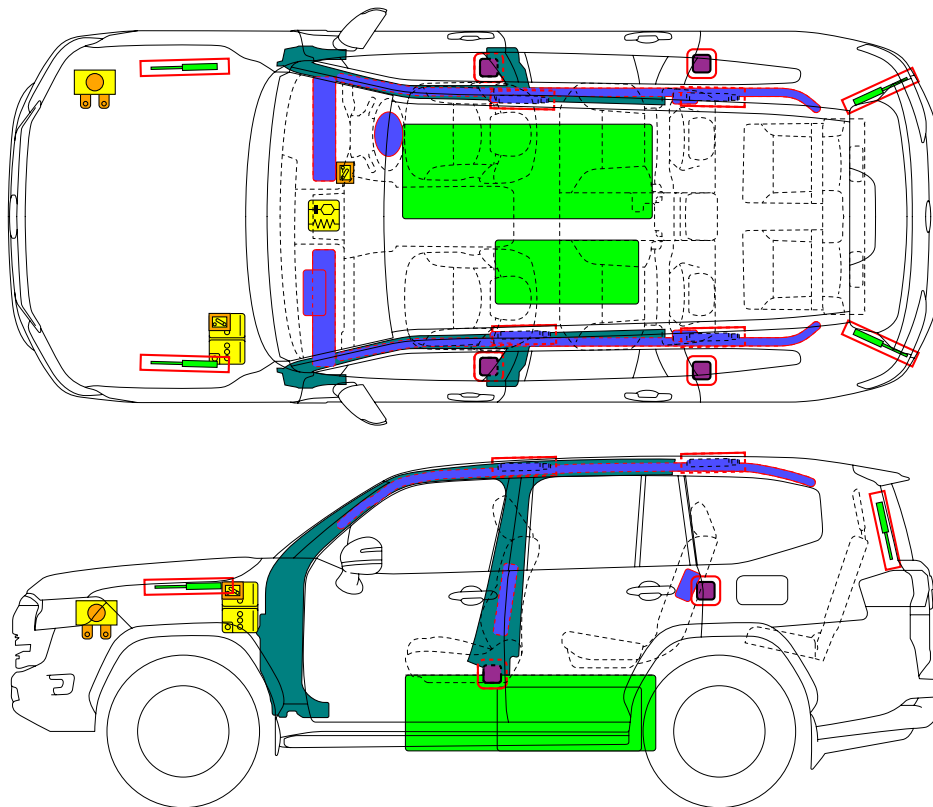
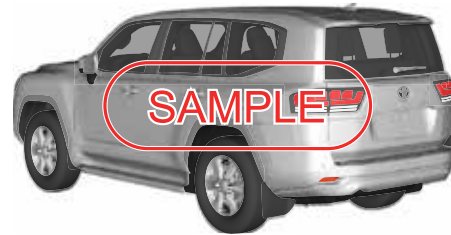

	Airbag		Stored gas inflator		Seat belt pretensioner		SRS control unit		Pedestrian protection active system
	Automatic rollover protection system		Gas strut / Preloaded spring		High strength zone		Zone requiring special attention		
	Battery low voltage		Ultra capacitor, low voltage		Fuel tank		Gas tank		Safety valve
	High voltage battery pack		High voltage power cable / component		High voltage disconnect		Fuse box disabling high voltage system		Ultra capacitor, high voltage
	Low voltage device that disconnects high voltage								
	ID No.	Version No.		Version date		Page			
	LANDCRUISER300	01		07 / 2021		1 / 4			

1. Identification / Recognition

■ Location of vehicle badges



2. Immobilisation / Stabilisation / Lifting

■ Completely immobilize the vehicle

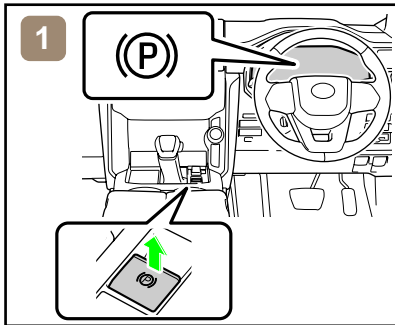

1. Chock the wheels and engage the parking brake.

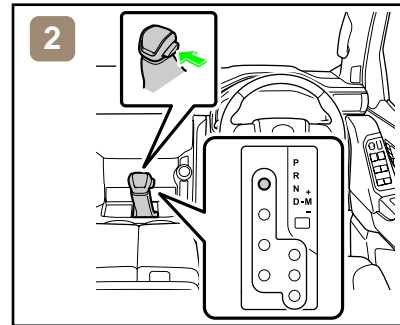

2. Move the shift lever to the park (P) position.

■ Stabilisation-lifting point

Place cribbing such as wooden blocks at the four points under the front and rear pillars.

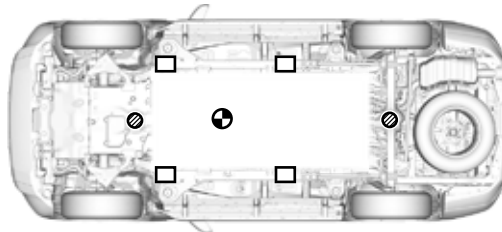

Extra Reinforced Lifting Points



Standard Jack Locations



Vehicle Center of Gravity



Do not place cribbing such as wooden blocks or rescue air lifting bags under the exhaust system or fuel system. Doing so may result in fuel leaks or fire.

3. Disable direct hazards / Safety regulations

■ If any of the following systems are required to be operated, operate them BEFORE disconnecting the battery.

Power door lock

Power window

Power back door opener

Electric parking brake

Power tilt and telescopic steering

Power seat

Sliding roof



When the 12 V battery is disconnected, electrical components cannot be operated.

	ID No.	Version No.	Version date	Page
	LANDCRUISER300	01	07 / 2021	2 / 4

■ Perform procedure Main or Alternative to completely shut off the vehicle.

<Procedure Main>

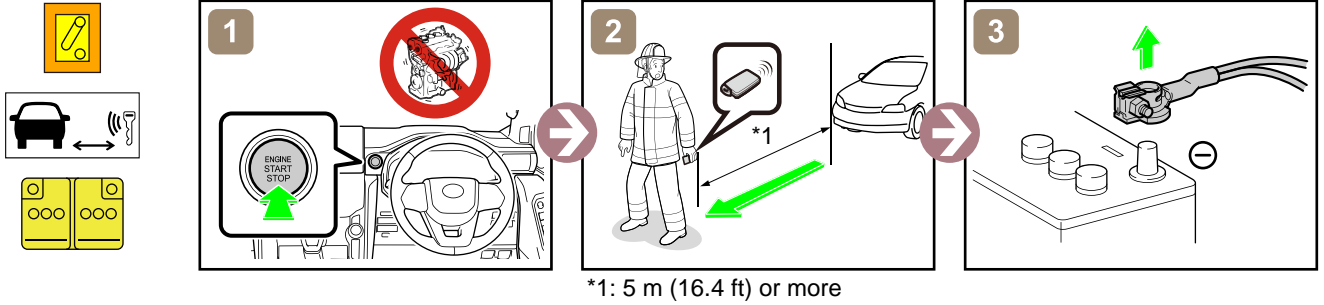

<Procedure Alternative>

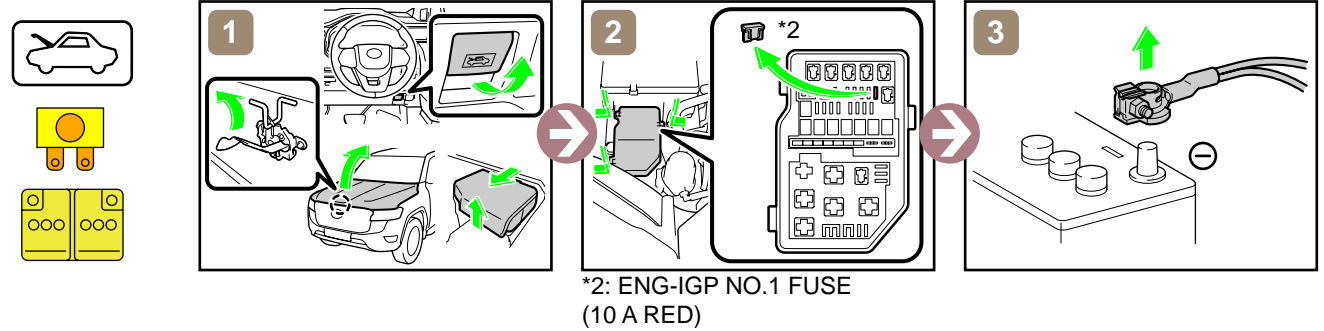

■ Access to 12 V Battery

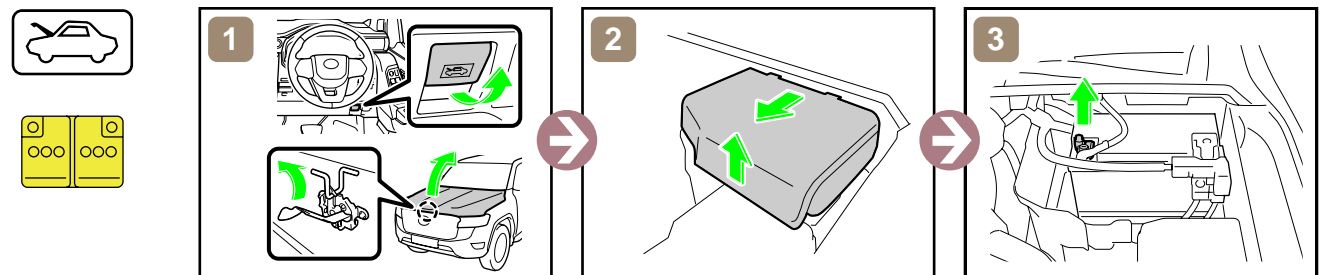

4. Access to the occupants

■ Window Glass

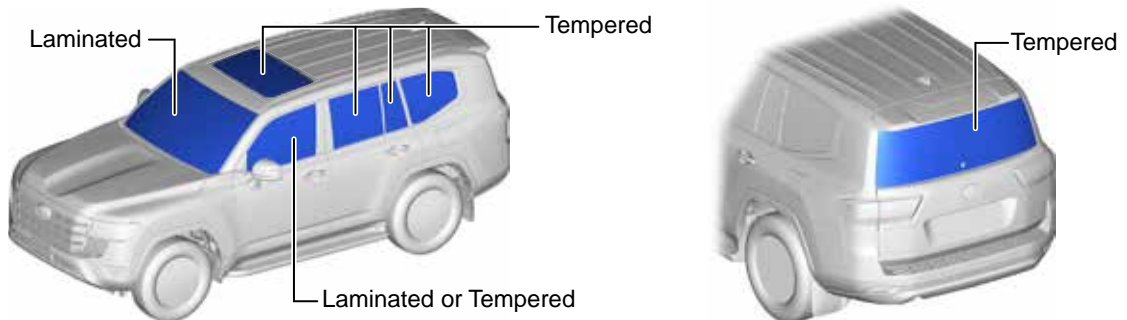

	ID No.	Version No.	Version date	Page
	LANDCRUISER300	01	07 / 2021	3 / 4

5. Stored energy / Liquids / Gases / Solids



12 V Battery



Diesel Tank: 110 L (80 L, 30 L)



Always wear appropriate personal protective equipment (PPE) when dealing with any of these items.

6. In case of fire



RE-IGNITION POSSIBLE !

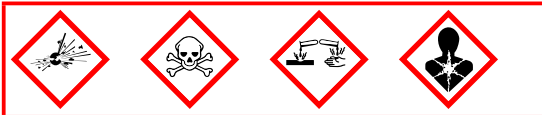

7. In case of submersion



Work on the vehicle only after the vehicle has been pulled out of the water.

8. Towing / Transportation / Storage

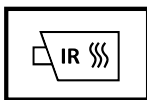
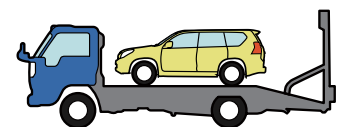

RE-IGNITION POSSIBLE !

Store the vehicle at a safe distance (15 m (49.2 ft) or more) from other vehicles.

9. Important additional information

For further details, please refer to "Emergency Response Guide".





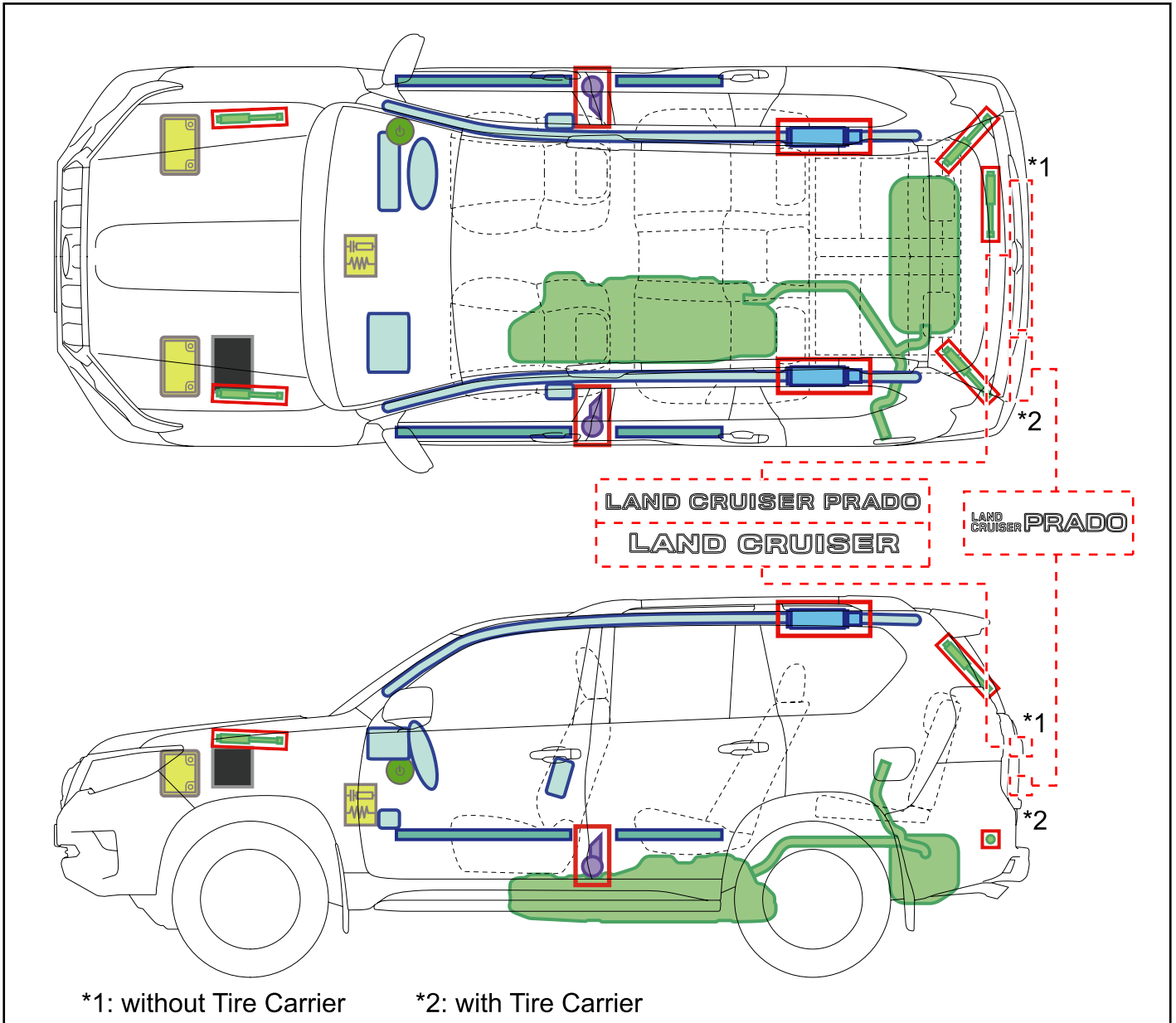





ID No.	Version No.	Version date	Page
LANDCRUISER300	01	07 / 2021	4 / 4

LAND
CRUISER
PRADO
5 DOOR / RHD
2013-8



*1: without Tire Carrier

*2: with Tire Carrier

	IG/POWER SW		Fuse Box		12V Battery
	Airbag (incl. Inflator)		Inflator		Fuel Tank
	Gas-filled Damper		Seat Belt Pretensioner (Gas Generator)		Structural Reinforcements
	Airbag Computer	—	—	—	—
—	—	—	—	—	—

Disable Vehicle

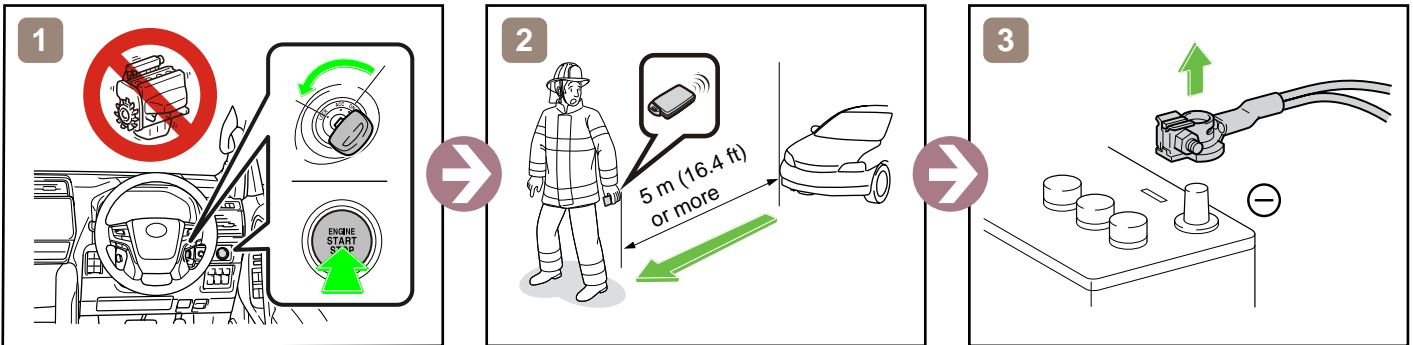

or

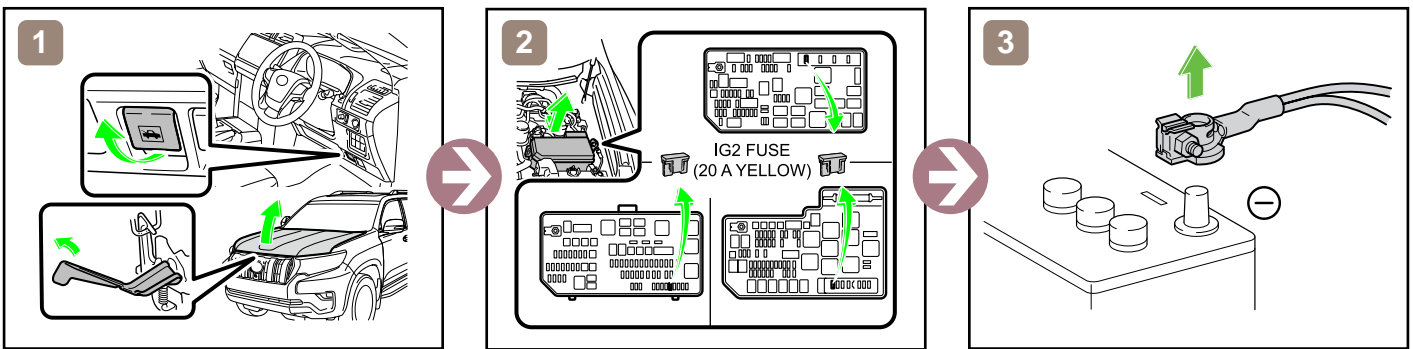

Access to 12V Battery

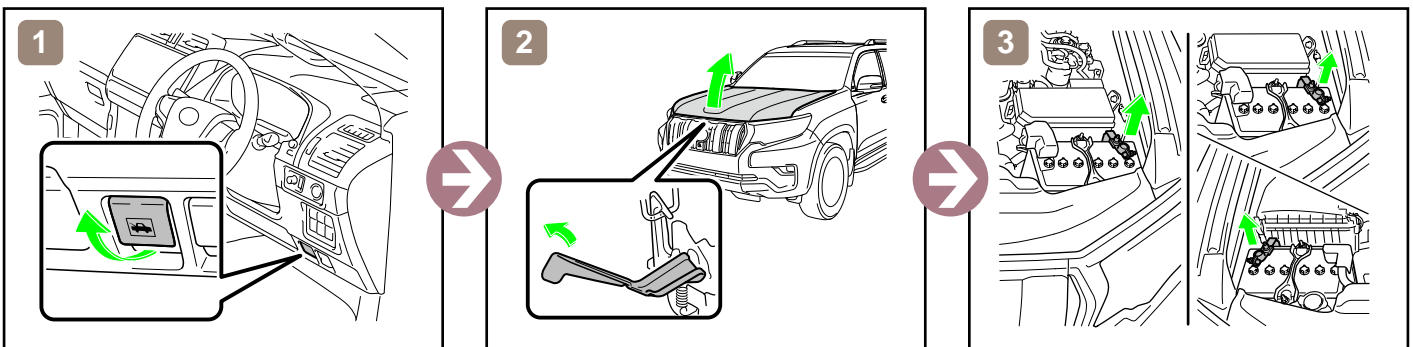

Towing Information

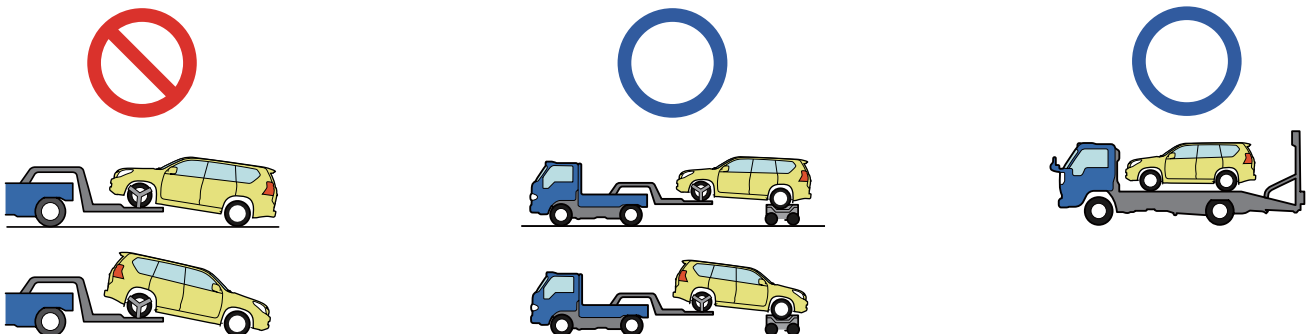

More details, please refer to "Emergency Response Guide".



TOYOTA LAND CRUISER / LAND CRUISER PRADO
 5 doors / 2 seats, 5 seats or 7 seats / wagon
 2024-01

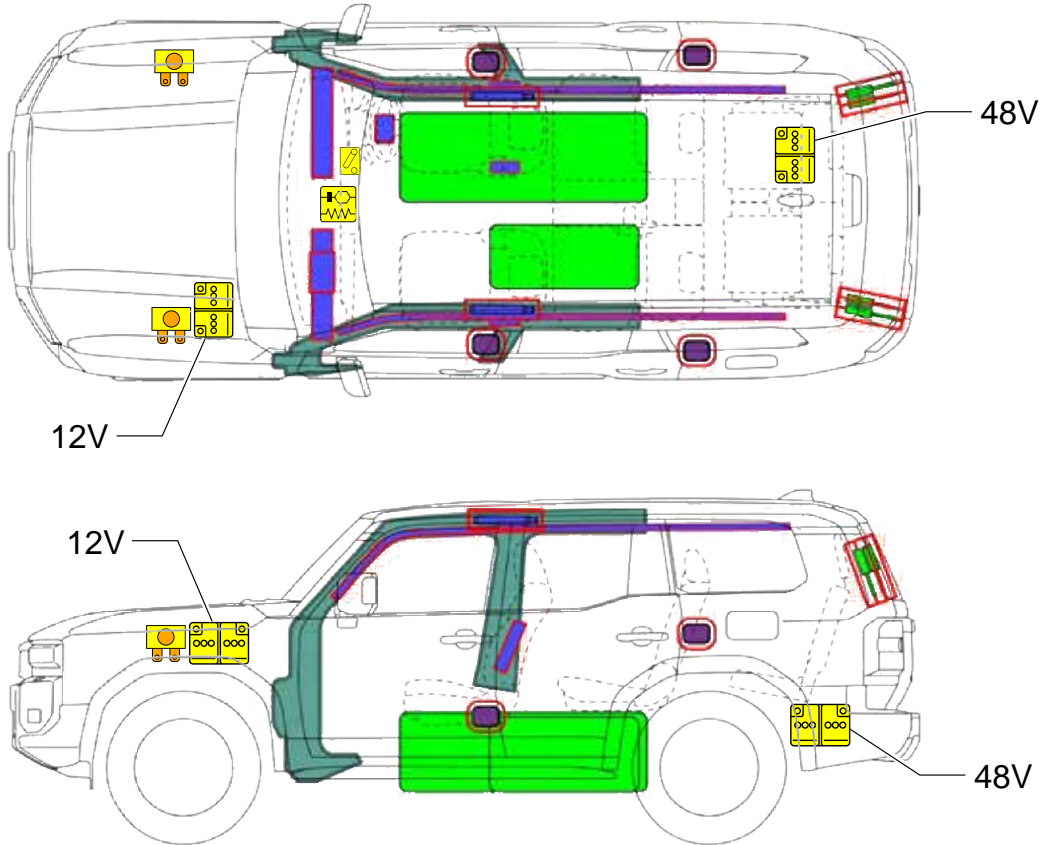
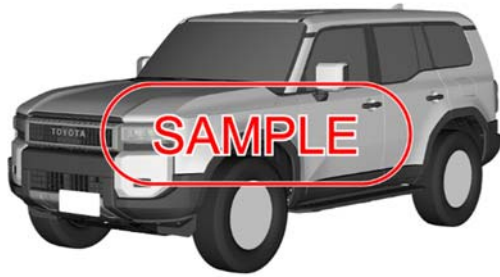

	Airbag		Stored gas inflator		Seat belt pretensioner		SRS control unit		
	Gas strut / Preloaded spring		High strength zone						
	Battery low voltage		Fuel tank						
	Device to shut down power in vehicle		Fuse box						
	ID No.	Version No.	Version date	Page					
	LANDCRUISERPRADODE250	02	04 / 2024	1 / 4					

1. Identification / Recognition



Lack of engine noise does not mean vehicle is off. Silent movement or instant restart capability exists until vehicle is fully shut down.

■ Location of vehicle badges

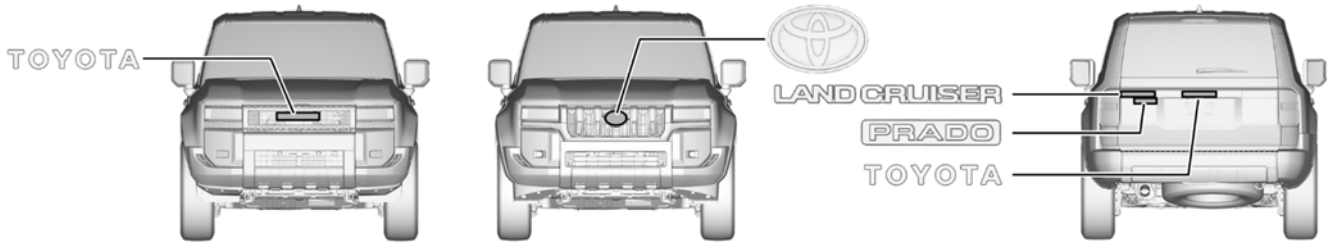

2. Immobilisation / Stabilisation / Lifting

■ Completely immobilize the vehicle

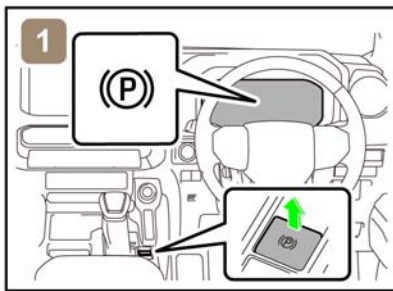

1) Chock the wheels and engage the parking brake.

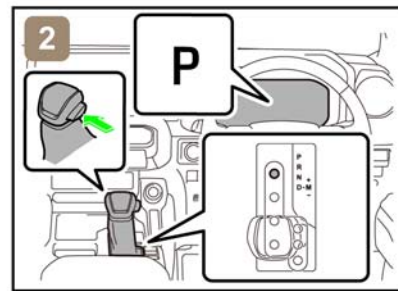

2) Move the shift lever to the park (P) position.

■ Stabilisation-lifting point

Place cribbing such as wooden blocks at the four points under the front and rear pillars.

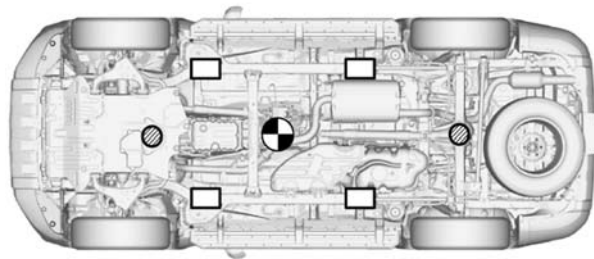

Extra Reinforced Lifting Points



Standard Jack Locations



Vehicle Center of Gravity



Do not place cribbing such as wooden blocks or rescue air lifting bags under the exhaust system or fuel system. Doing so may result in fuel leaks or fire.

ID No.	Version No.	Version date	Page
LANDCRUISERPRADODE250	02	04 / 2024	2 / 4

3. Disable direct hazards / Safety regulations

- If any of the following systems are required to be operated, operate them **BEFORE** disconnecting the battery.

Power door lock

Power window

Power seat

Power tilt and telescopic steering

Electric parking brake

Power back door

Sliding roof

Panoramic moon roof

When the 12 V battery is disconnected, electrical components cannot be operated.

- Perform procedure Main or Alternative to completely shut off the vehicle.

<Main Procedure>

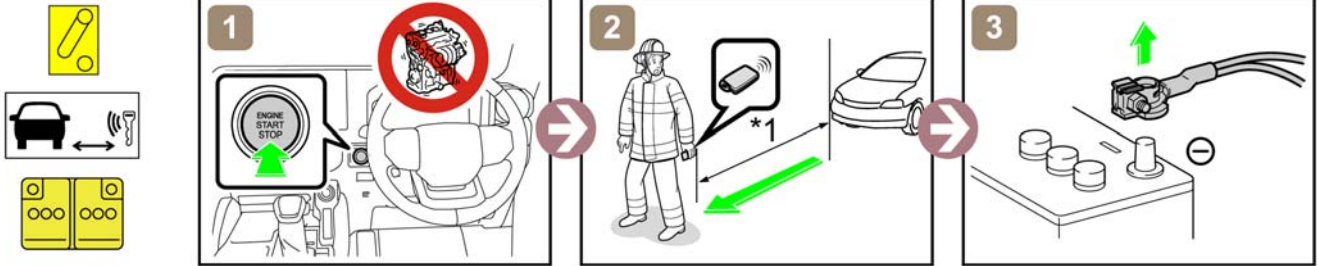

*1: 5 m (16.4 ft) or more

<Alternative Procedure>

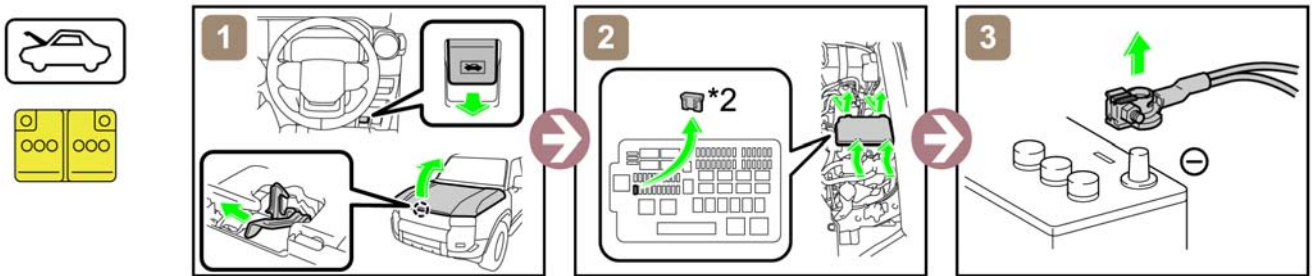

*2: EFI NO.2 FUSE (7.5 A BROWN)

- Access to 12 V Battery

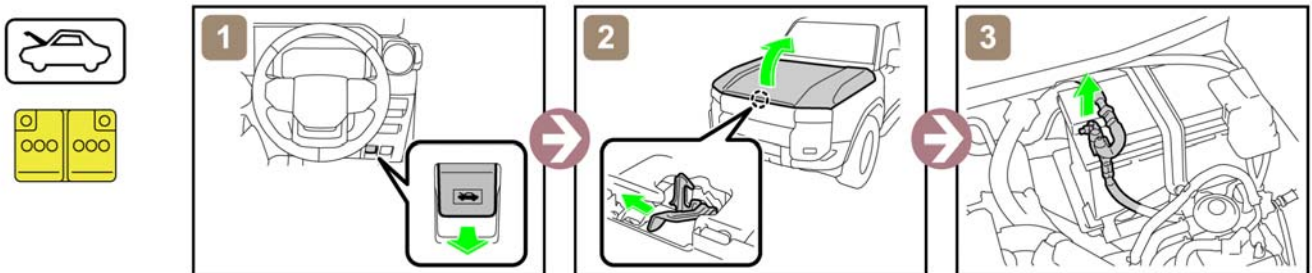

4. Access to the occupants

- Window Glass

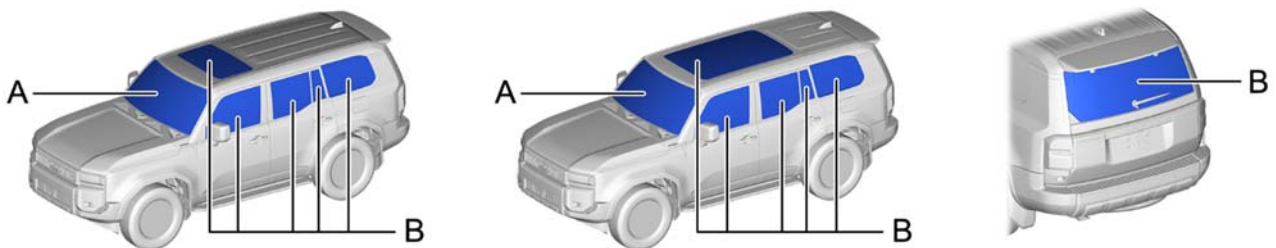

A	Laminated	B	Tempered
---	-----------	---	----------

	ID No.	Version No.	Version date	Page
	LANDCRUISERPRADODE250	02	04 / 2024	3 / 4

5. Stored energy / Liquids / Gases / Solids



12 V Battery, 48V Battery



Diesel Tank: 80 L / 110 L (80 L, 30 L)



Always wear appropriate personal protective equipment (PPE) when dealing with any of these items.

6. In case of fire



USE COPIOUS AMOUNTS OF WATER

If it is difficult to apply copious amounts of water to the 48V battery, it is recommended to allow the 48V battery to burn itself out.



RE-IGNITION POSSIBLE !



7. In case of submersion



Work on the vehicle only after the vehicle has been pulled out of the water.

8. Towing / Transportation / Storage

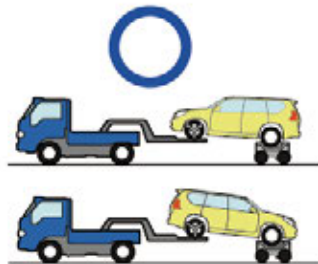
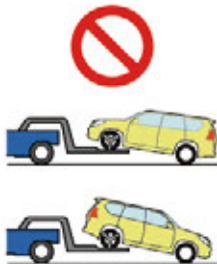

RE-IGNITION POSSIBLE !

Store the vehicle at a safe distance (15 m (49.2 ft) or more) from other vehicles.

9. Important additional information

For further details, please refer to "Emergency Response Guide".

ID No.	Version No.	Version date	Page
LANDCRUISERPRADODE250	02	04 / 2024	4 / 4

MIRAI

2015-6



TOYOTA

FUELCELL

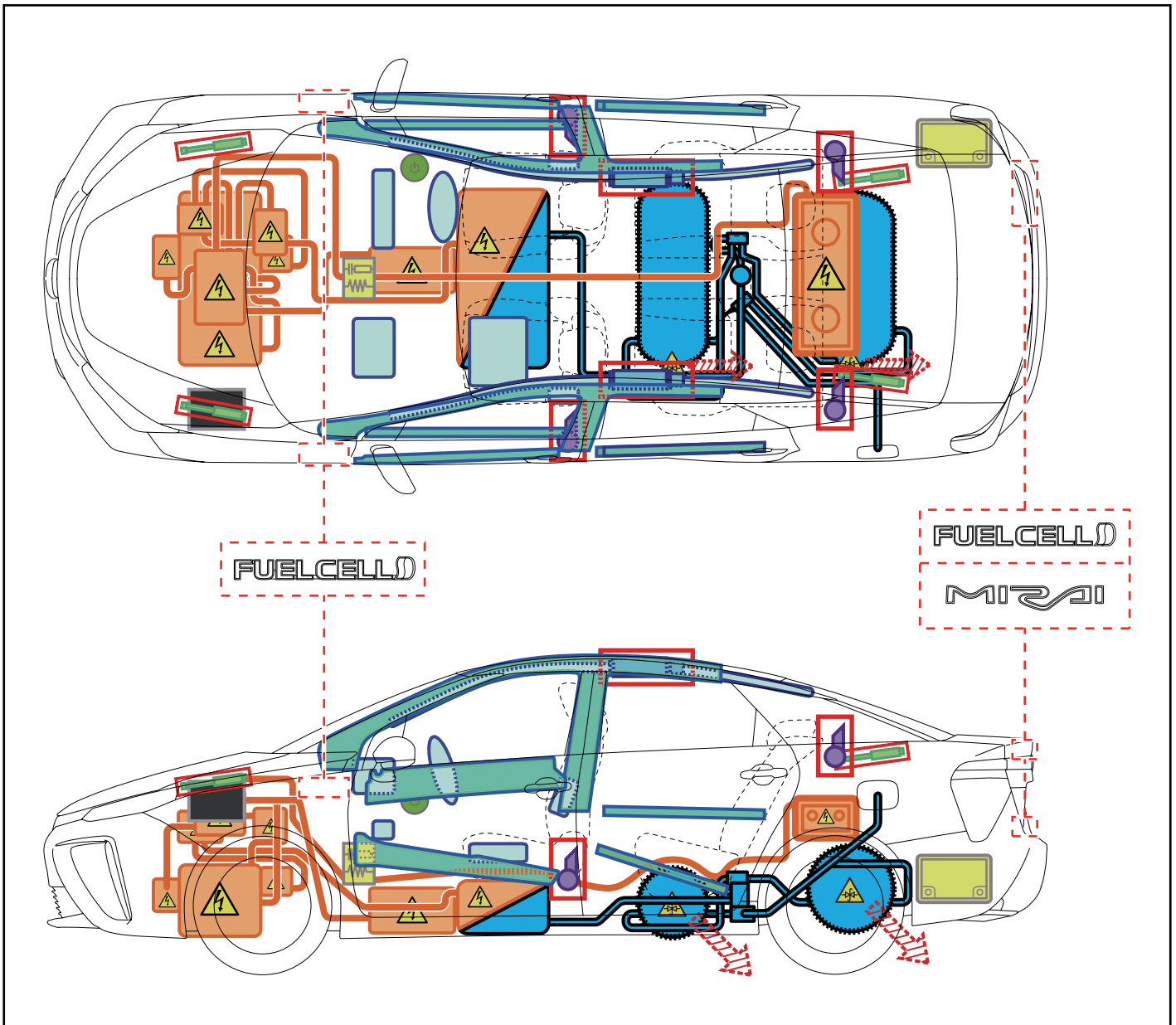

	POWER SW		Structural Reinforcements		Airbag Computer
	Airbag (incl. Inflator)		Fuse Box		12V Battery
	High Voltage Components		Inflator		High Voltage Battery
	Pressure relief device (PRD) (Hydrogen release direction)		Hydrogen Tank		Hydrogen Components
			Gas-filled Damper		Seat Belt Pretensioner (Gas Generator)

Disable Vehicle

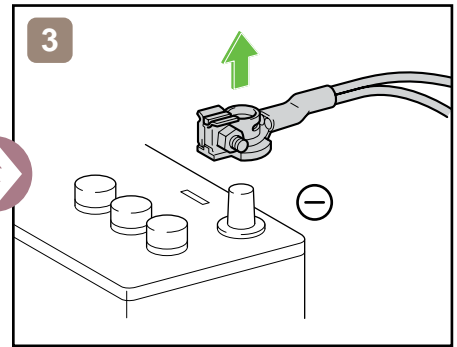
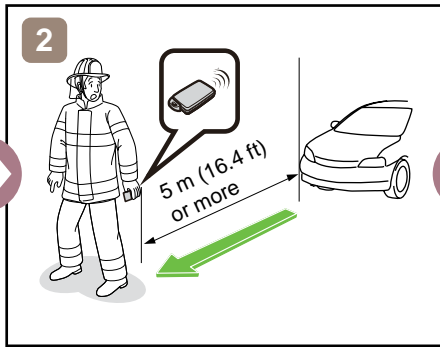
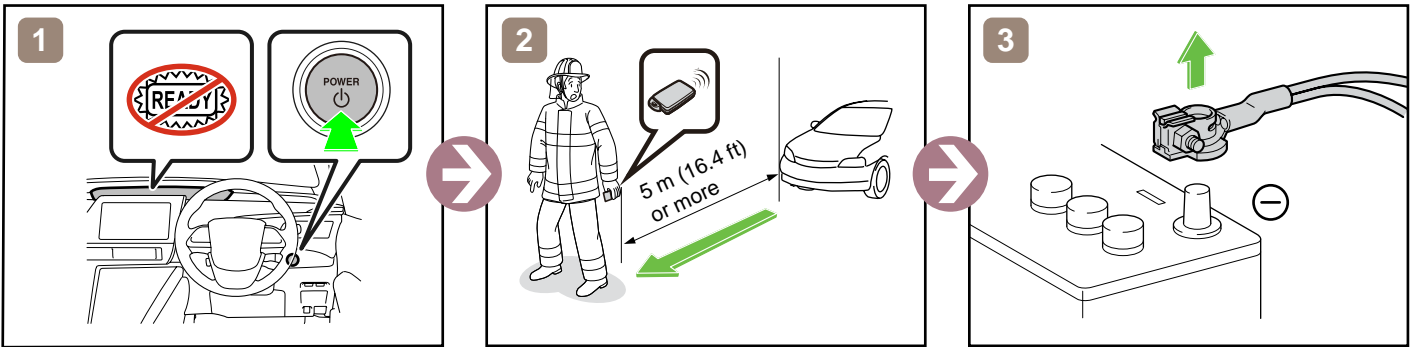

or

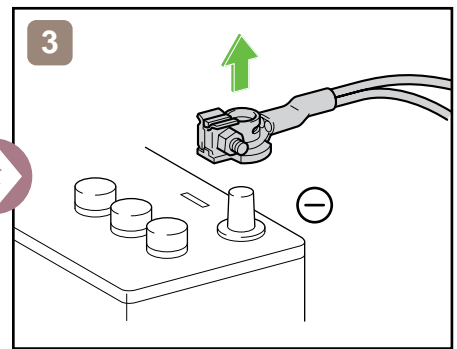
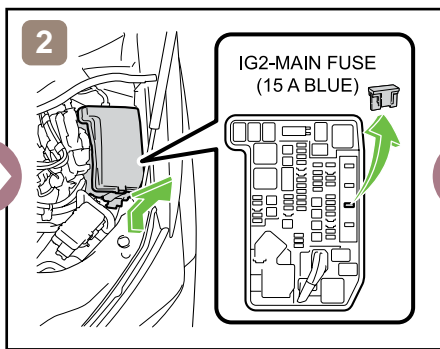
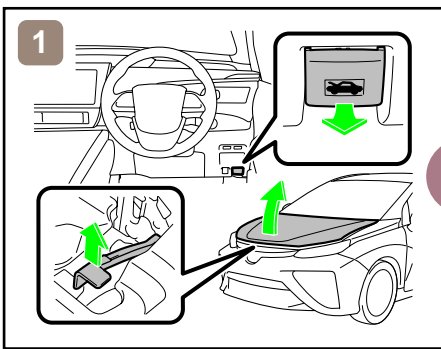

Access to 12V Battery

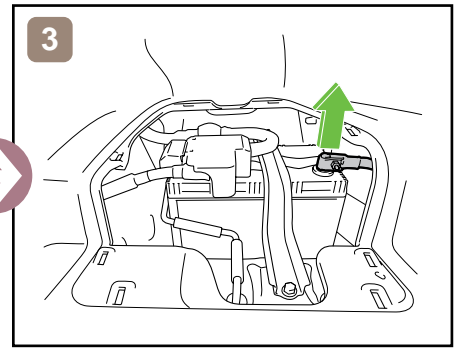
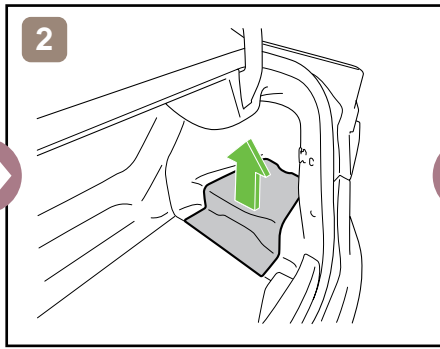
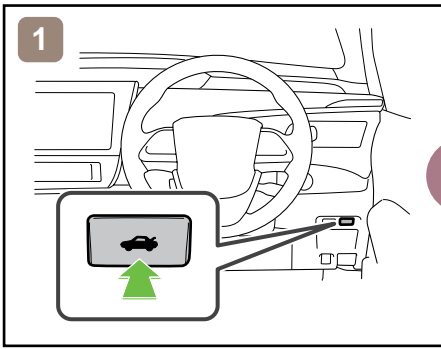

Towing Information

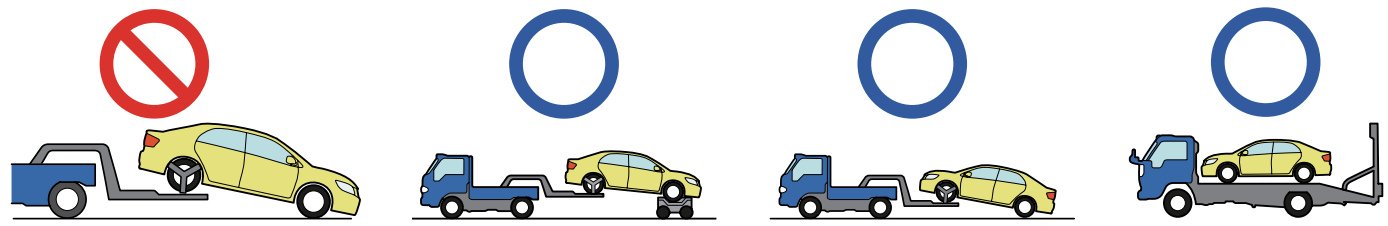

More details, please refer to "Emergency Response Guide".



TOYOTA MIRAI

2020-11

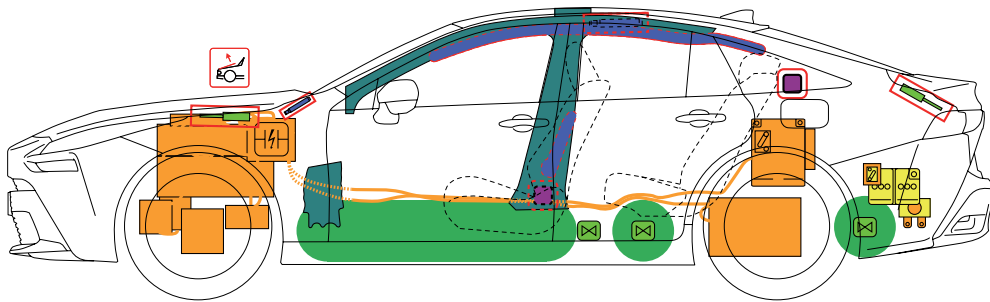
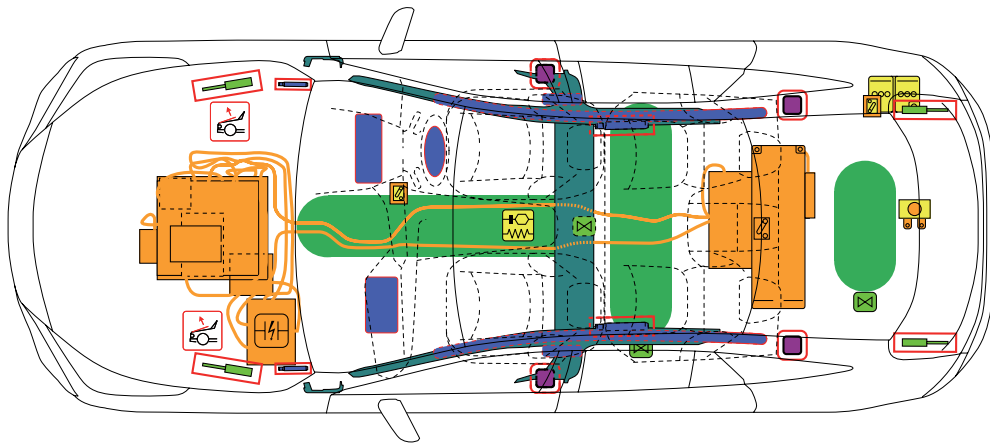

	Airbag		Stored gas inflator		Seat belt pretensioner		SRS control unit		Pedestrian protection active system
	Automatic rollover protection system		Gas strut / Preloaded spring		High strength zone		Zone requiring special attention		
	Battery low voltage		Ultra capacitor, low voltage		Fuel tank		Gas tank		Safety valve
	High voltage battery pack		High voltage power cable / component		High voltage disconnect		Fuse box disabling high voltage system		Ultra capacitor, high voltage
	Low voltage device that disconnects high voltage								
	ID No.	Version No.		Version date		Page			
	MIRAI20	02		11 / 2020		1 / 4			

1. Identification / Recognition

Location of vehicle badges

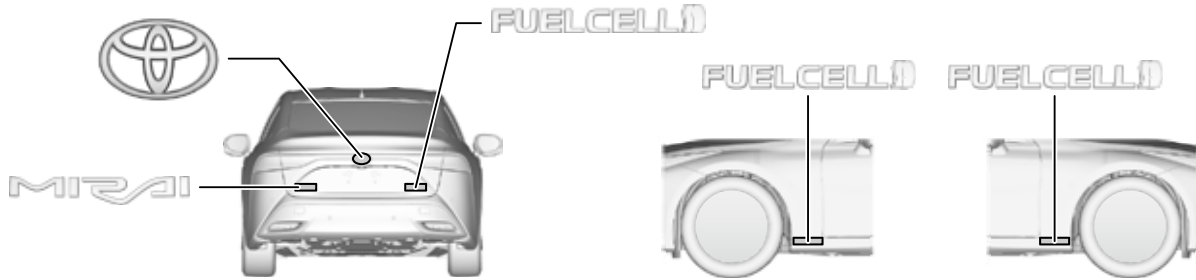

Energy source: Lithium-ion battery



2. Immobilisation / Stabilisation / Lifting

Completely immobilize the vehicle

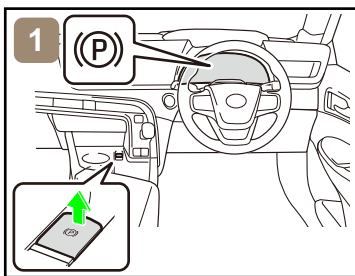

1. Chock the wheels and engage the parking brake.

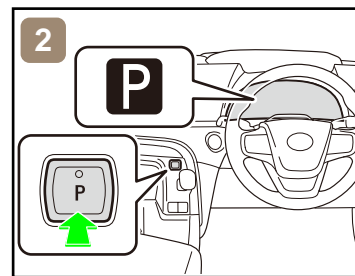

2. Press the P position switch.

Stabilisation-lifting point

Place cribbing such as wooden blocks at the four points under the front and rear pillars.

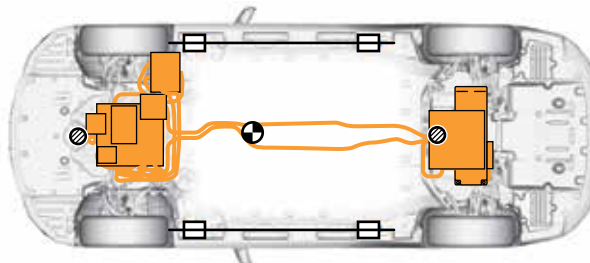

Extra Reinforced Lifting Points



Standard Jack Locations



Vehicle Center of Gravity



Do not place cribbing such as wooden blocks or rescue air lifting bags under the fuel system or high voltage power cables. Doing so may result in fuel leaks, fire, or electric shock.

3. Disable direct hazards / Safety regulations

If any of the following systems are required to be operated, operate them BEFORE disconnecting the battery.

Power door lock

Power window

Trunk opener

Electric parking brake

Power tilt and telescopic steering

Power seat



When the 12 V battery is disconnected, electrical components cannot be operated.

ID No.	Version No.	Version date	Page
MIRAI20	02	11 / 2020	2 / 4

■ Perform procedure Main or Alternative to completely shut off the vehicle.

<Procedure Main>

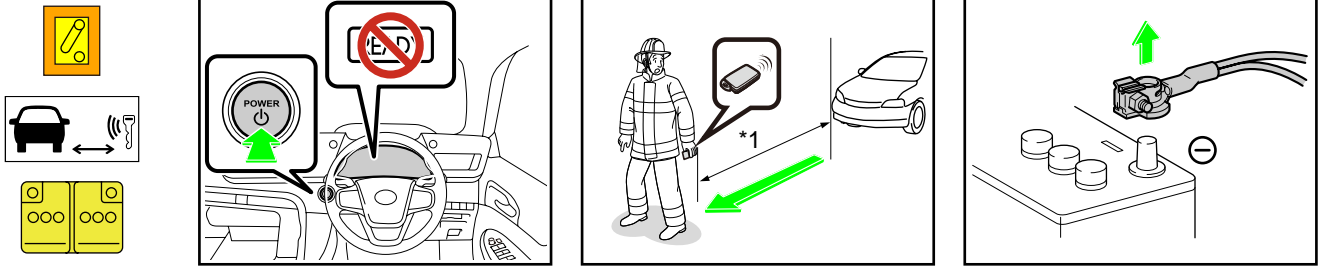

*1: 5 m (16.4 ft) or more

<Procedure Alternative>

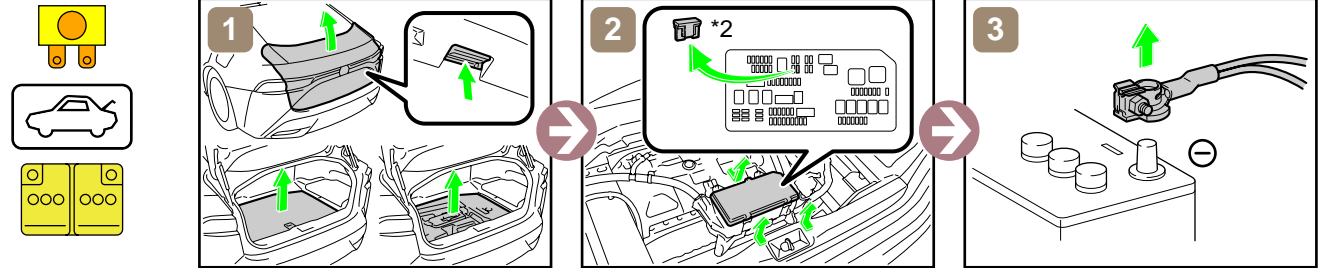

*2: IG2 P NO.1 FUSE (10 A RED)

■ Access to 12 V Battery

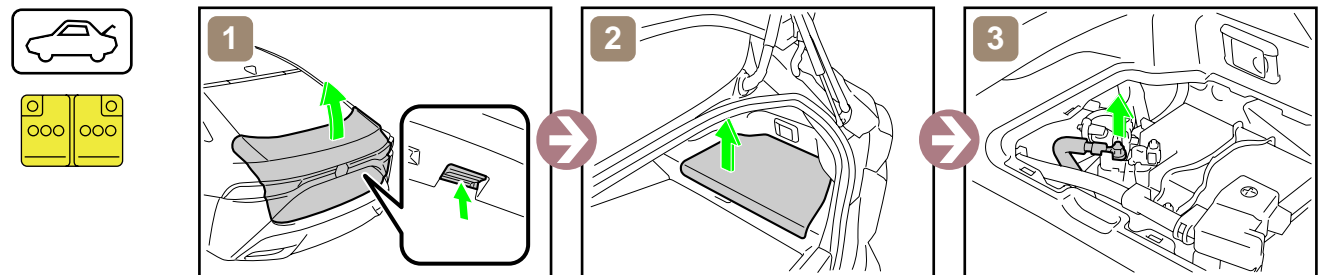

4. Access to the occupants

■ Window Glass

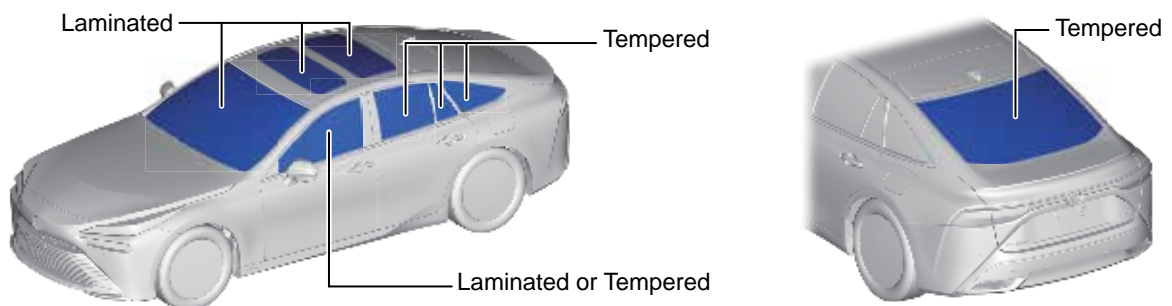

5. Stored energy / Liquids / Gases / Solids



High Voltage Li-ion Battery



12 V Battery



Hydrogen Tank: 142.2 L (64.9 L, 52 L, 25.3 L)

	ID No.	Version No.	Version date	Page
	MIRAI20	02	11 / 2020	3 / 4



- Always wear appropriate personal protective equipment (PPE) when dealing with any of these items.
- Never breach or remove the battery assembly cover under any circumstances, including fire. Doing so may result in serious injury or death from severe burns or electric shock.

6. In case of fire



USE COPIOUS AMOUNTS OF WATER

If it is difficult to apply copious amounts of water to the high voltage battery, it is recommended to allow the high voltage battery to burn itself out.

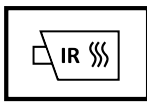

RE-IGNITION POSSIBLE !



7. In case of submersion



Do not touch any of the high-voltage components or cables, including the service plug, while the vehicle is submerged. Doing so may result in electric shock.
Work on the vehicle only after the vehicle has been pulled out of the water.

8. Towing / Transportation / Storage

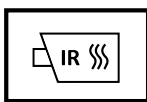
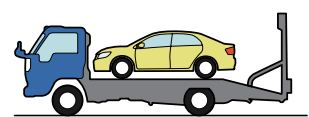
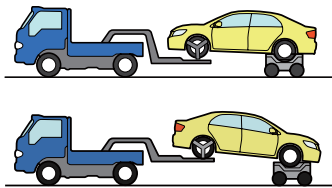
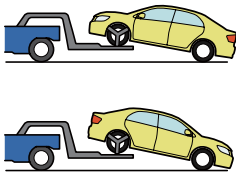

RE-IGNITION POSSIBLE !

Store the vehicle at a safe distance (15 m (49.2 ft) or more) from other vehicles.

9. Important additional information

For further details, please refer to "Emergency Response Guide".

	ID No.	Version No.	Version date	Page
	MIRAI20	02	11 / 2020	4 / 4



TOYOTA MIRAI
4 doors / 5 seats / sedan
2023-12

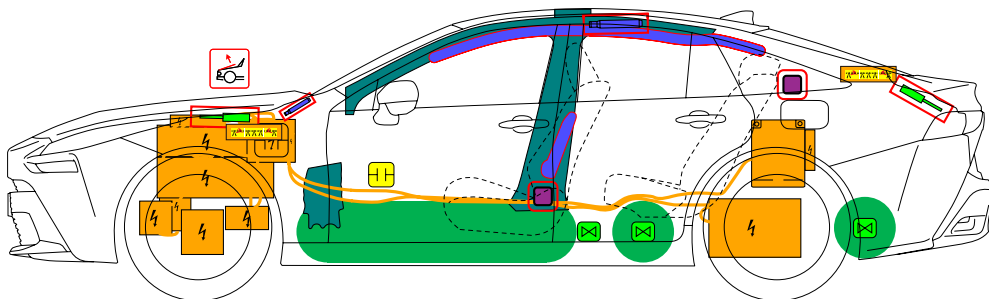
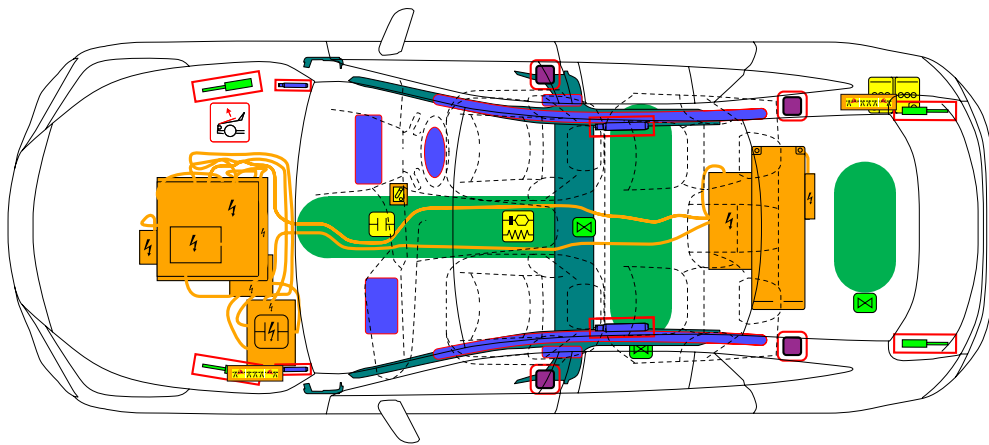

	Airbag		Stored gas inflator		Seat belt pretensioner		SRS control unit		Pedestrian protection active system
	Gas strut / Preloaded spring		High strength zone						
	Battery low voltage		Ultra capacitor, low voltage		Gas tank		Safety valve		
	High voltage battery pack		High voltage power cable / component		Ultra capacitor, high voltage		Low voltage device that disconnects high voltage		Cable Cut
	ID No.	Version No.		Version date		Page			
	MIRAI20	03		12 / 2023		1 / 4			

1. Identification / Recognition

■ Location of vehicle badges



■ Energy source: Lithium-ion battery



2. Immobilisation / Stabilisation / Lifting

■ Completely immobilize the vehicle

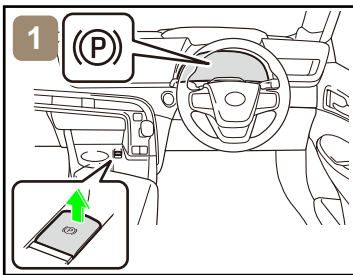

1. Chock the wheels and engage the parking brake.

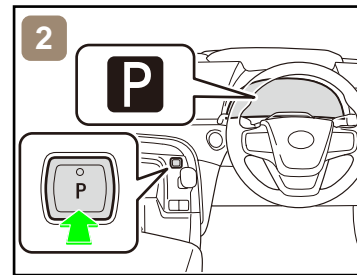

2. Press the P position switch.

■ Stabilisation-lifting point

Place cribbing such as wooden blocks at the four points under the front and rear pillars.

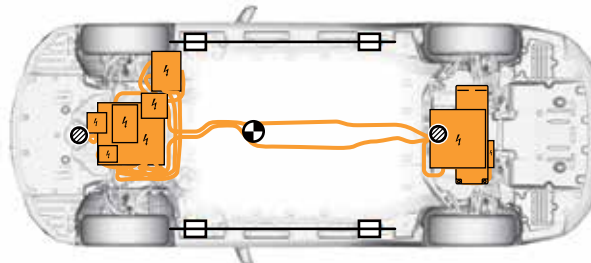

Extra Reinforced Lifting Points



Standard Jack Locations



Vehicle Center of Gravity



Do not place cribbing such as wooden blocks or rescue air lifting bags under the fuel system or high voltage power cables. Doing so may result in fuel leaks, fire, or electric shock.

3. Disable direct hazards / Safety regulations

■ If any of the following systems are required to be operated, operate them BEFORE disconnecting the battery.

Power door lock

Power window

Trunk opener

Electric parking brake

Power tilt and telescopic steering

Power seat

When the 12 V battery is disconnected, electrical components cannot be operated.

	ID No.	Version No.	Version date	Page
	MIRAI20	03	12 / 2023	2 / 4

■ Perform procedure Main or Alternative to completely shut off the vehicle.

<Procedure Main>

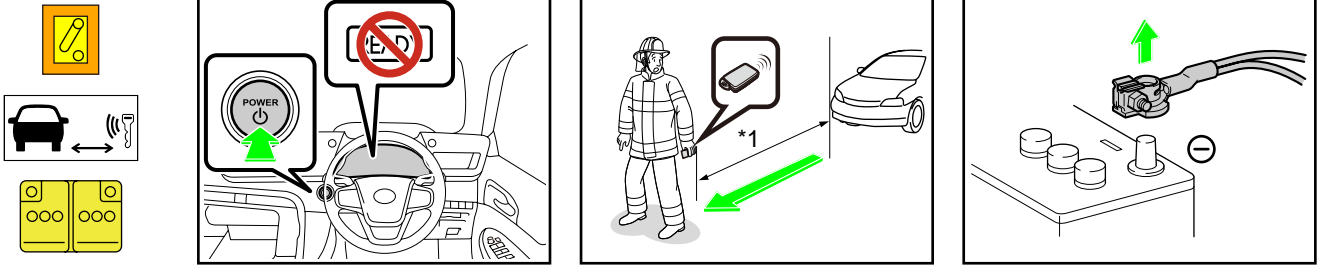

*1: 5 m (16.4 ft) or more

<Procedure Alternative>

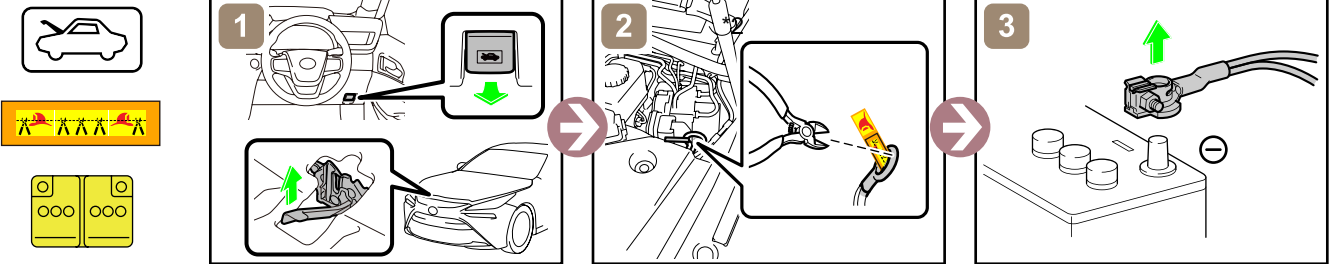

In the event of an accident in which the airbags are deployed, the high-voltage system will be automatically deactivated.

■ Access to 12 V Battery

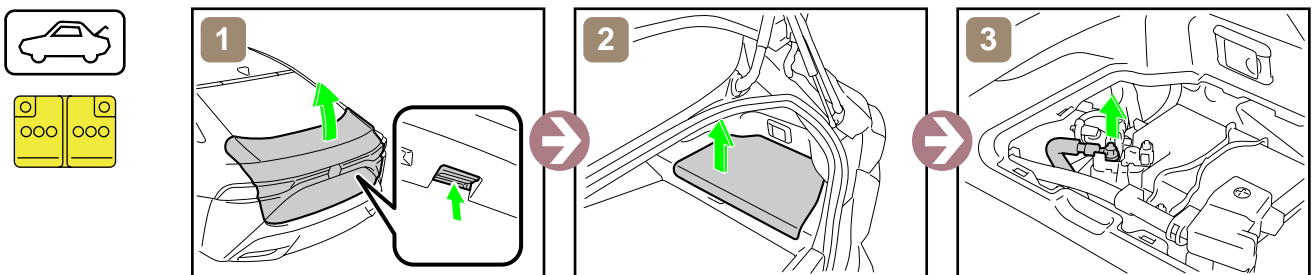

4. Access to the occupants

■ Window Glass

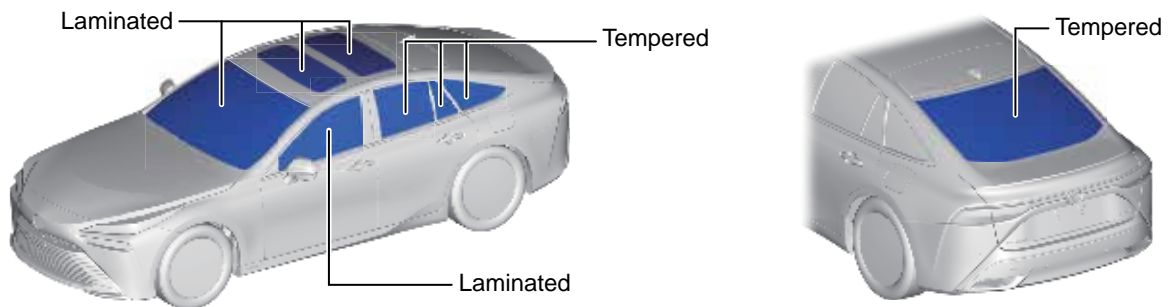

5. Stored energy / Liquids / Gases / Solids



High Voltage Li-ion Battery



12 V Battery



Hydrogen Tank: 142.2 L (64.9 L, 52 L, 25.3 L) / 116.9 L (64.9 L, 52 L)

ID No.	Version No.	Version date	Page
MIRAI20	03	12 / 2023	3 / 4



- Always wear appropriate personal protective equipment (PPE) when dealing with any of these items.
- Never breach or remove the battery assembly cover under any circumstances, including fire. Doing so may result in serious injury or death from severe burns or electric shock.

6. In case of fire



USE COPIOUS AMOUNTS OF WATER

If it is difficult to apply copious amounts of water to the high voltage battery, it is recommended to allow the high voltage battery to burn itself out.

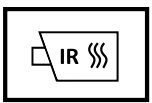

RE-IGNITION POSSIBLE !



7. In case of submersion



- Do not touch any of the high-voltage components or cables, including the service plug, while the vehicle is submerged. Doing so may result in electric shock.
- Work on the vehicle only after the vehicle has been pulled out of the water.

8. Towing / Transportation / Storage

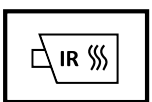
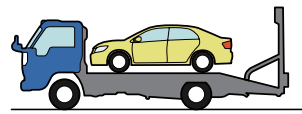
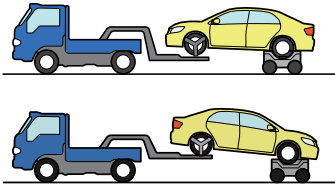
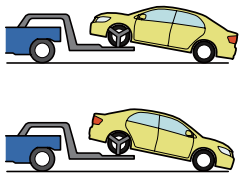

RE-IGNITION POSSIBLE !









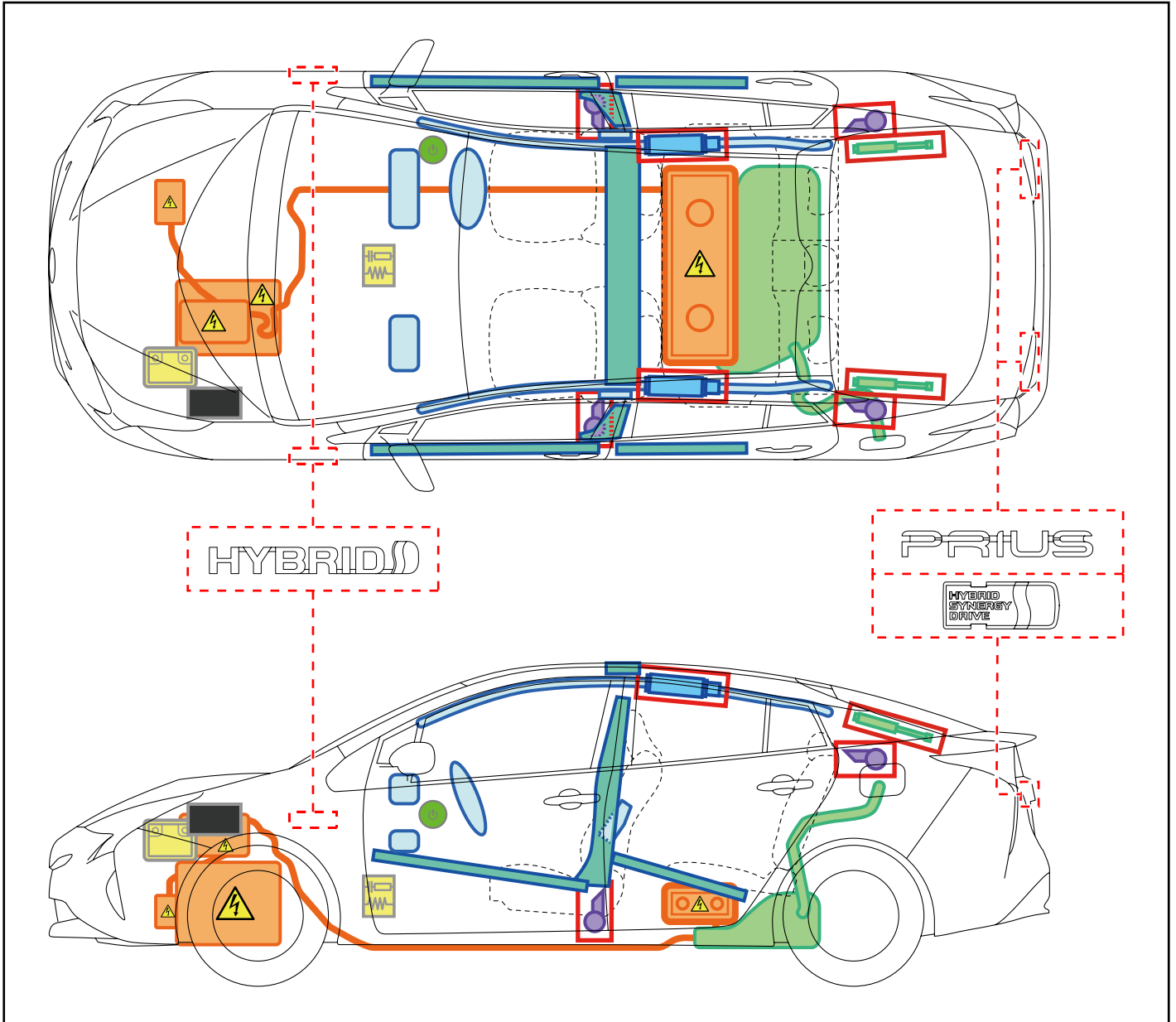
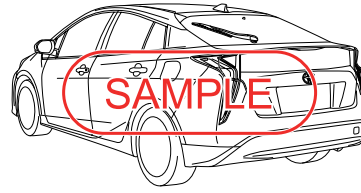
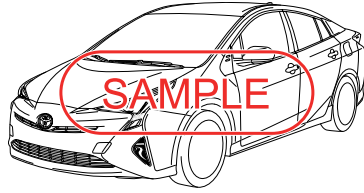



Store the vehicle at a safe distance (15 m (49.2 ft) or more) from other vehicles.

9. Important additional information

For further details, please refer to "Emergency Response Guide".

	ID No.	Version No.	Version date	Page
	MIRAI20	03	12 / 2023	4 / 4



	POWER SW		Fuse Box		12V Battery
	Airbag (incl. Inflator)		Inflator		High Voltage Battery
	High Voltage Components		Fuel Tank		Gas-filled Damper
	Seat Belt Pretensioner (Gas Generator)		Structural Reinforcements		Airbag Computer
-	-	-	-	-	-

Disable Vehicle

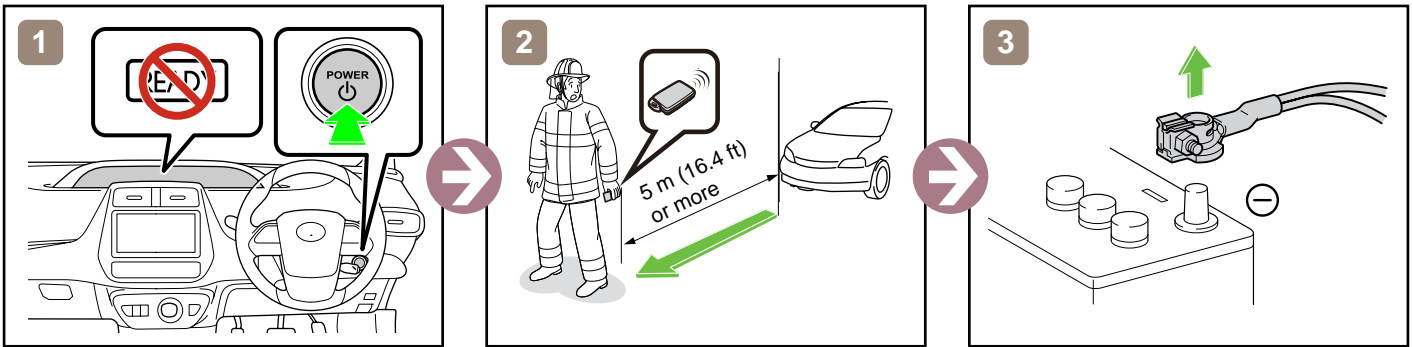

or

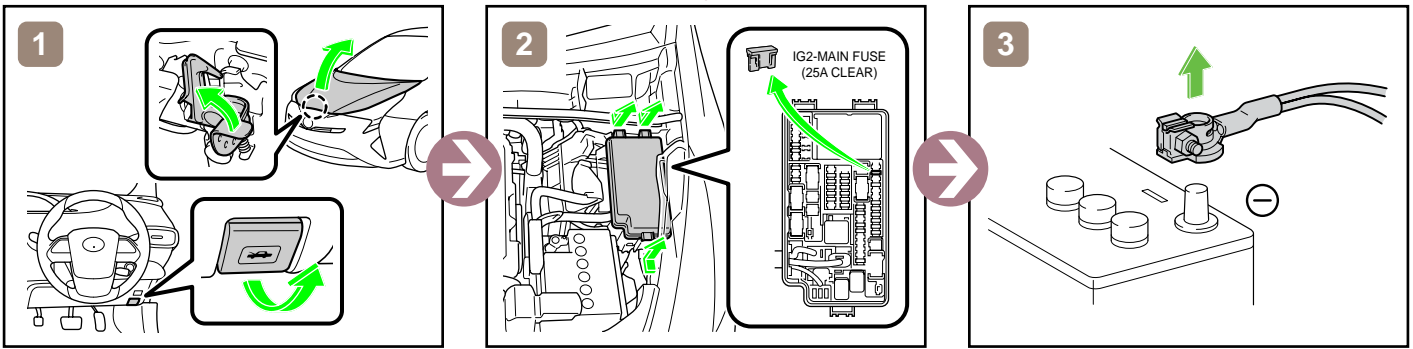

Access to 12V Battery

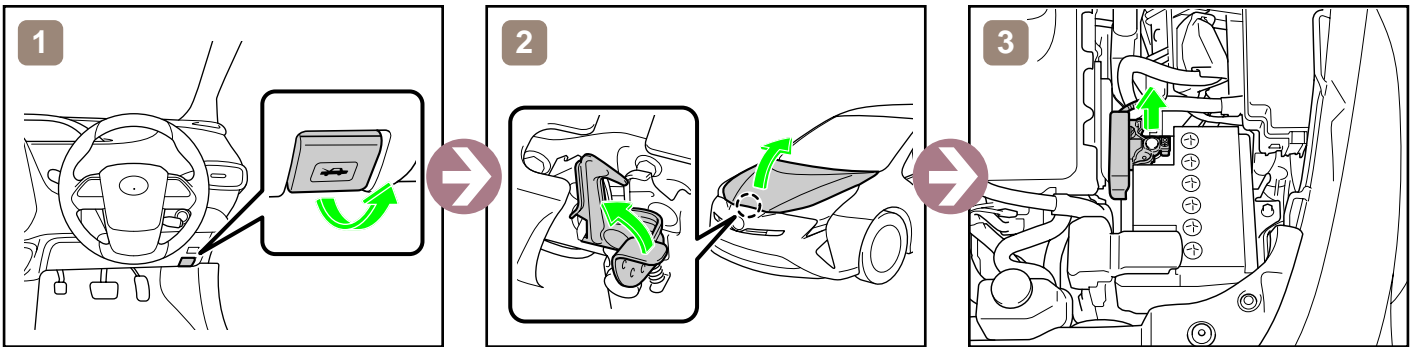

Towing Information

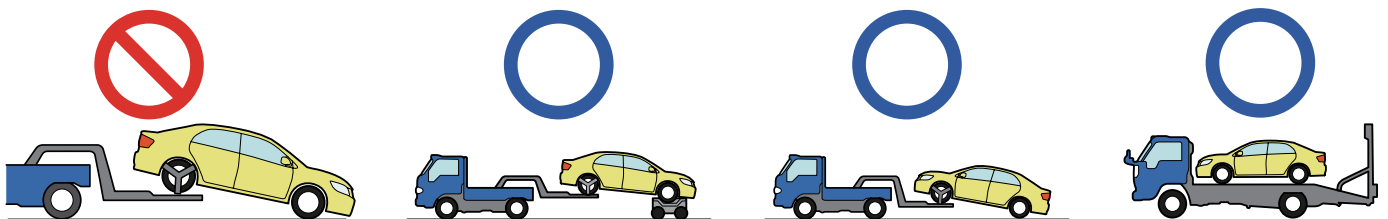









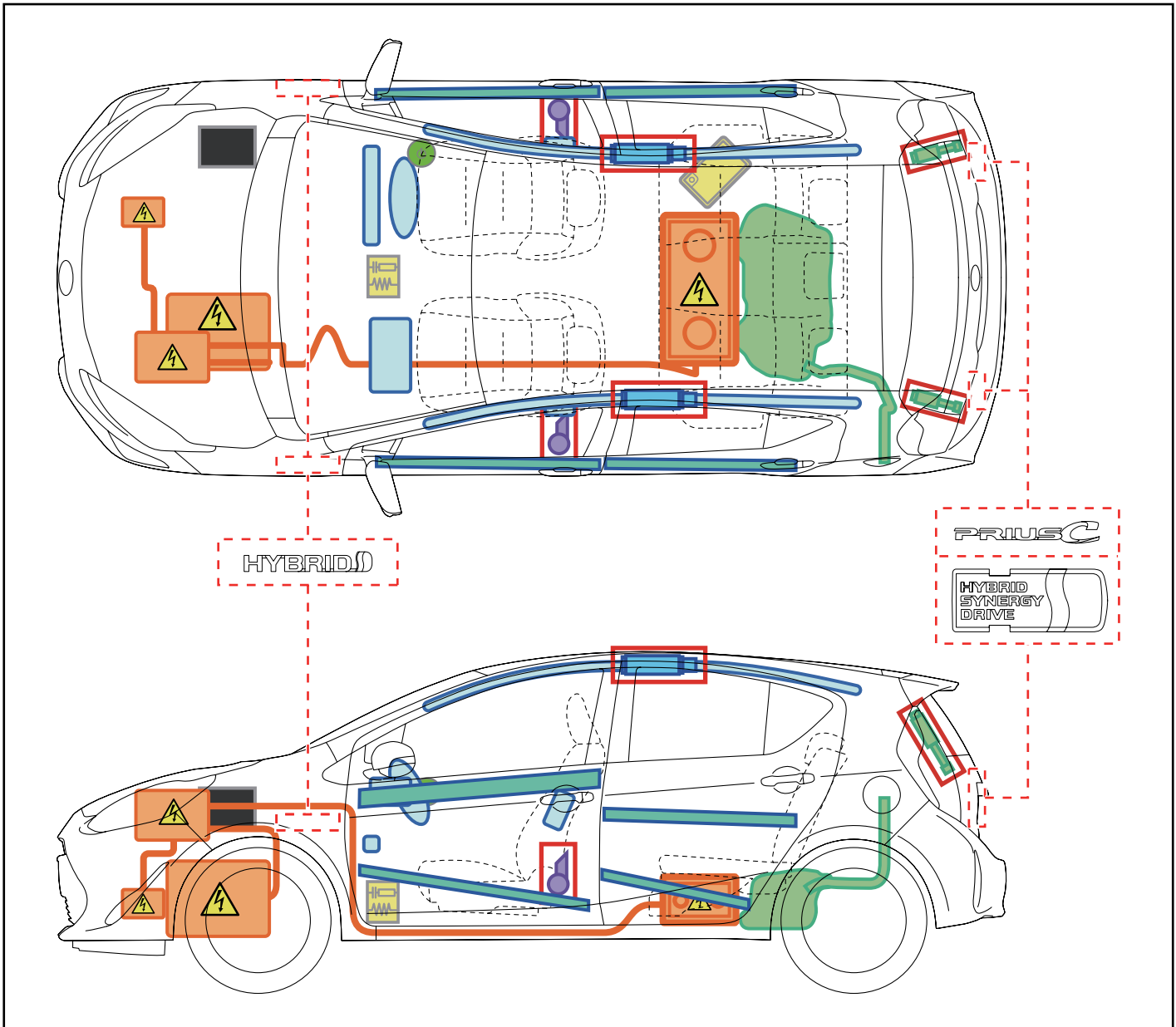
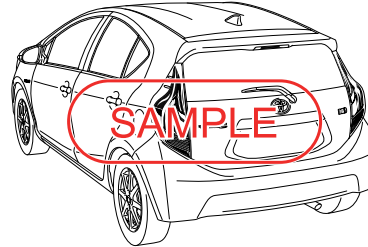
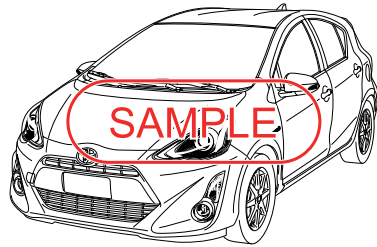



More details, please refer to "Emergency Response Guide".

PRIUS C

RHD

2014-12



	IG/POWER SW		Fuse Box		12V Battery
	Airbag (incl. Inflator)		Inflator		High Voltage Battery
	High Voltage Components		Fuel Tank		Gas-filled Damper
	Seat Belt Pretensioner (Gas Generator)		Structural Reinforcements		Airbag Computer
-	-	-	-	-	-

Disable Vehicle

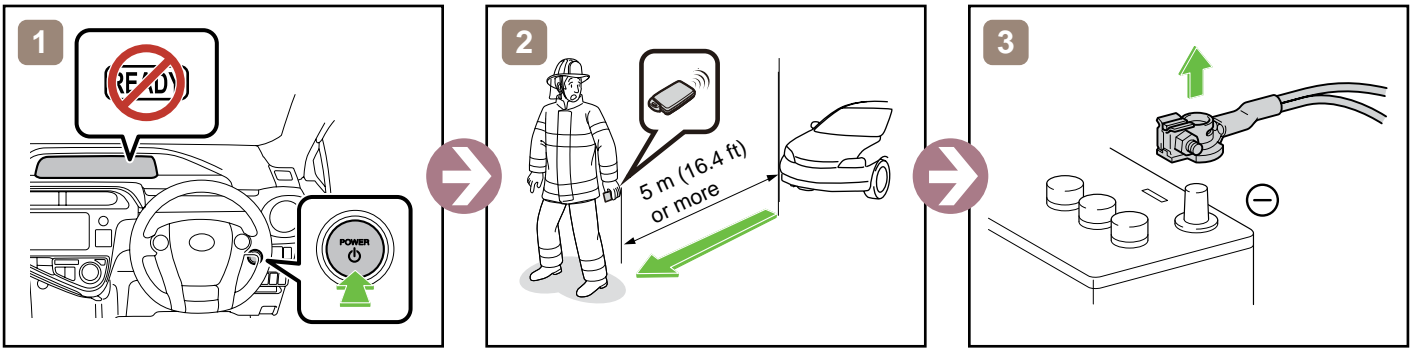

or

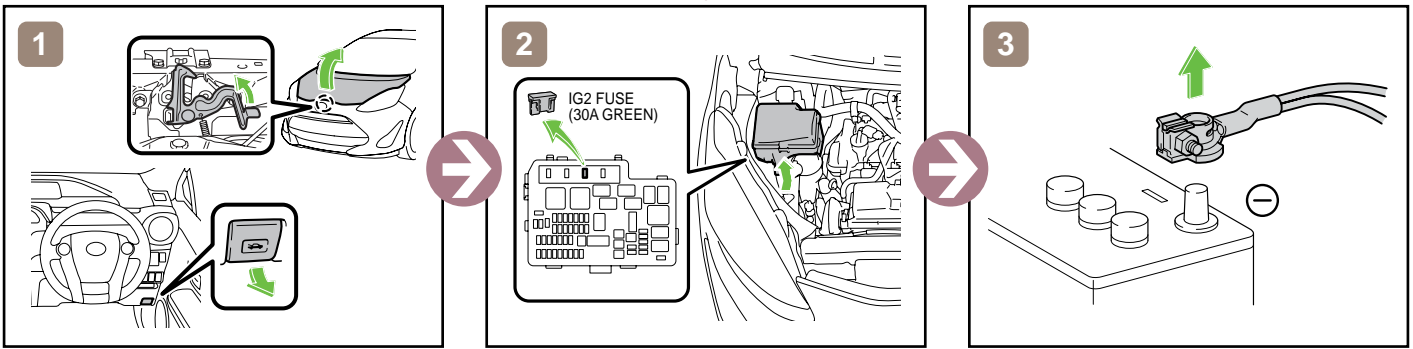

Access to 12V Battery

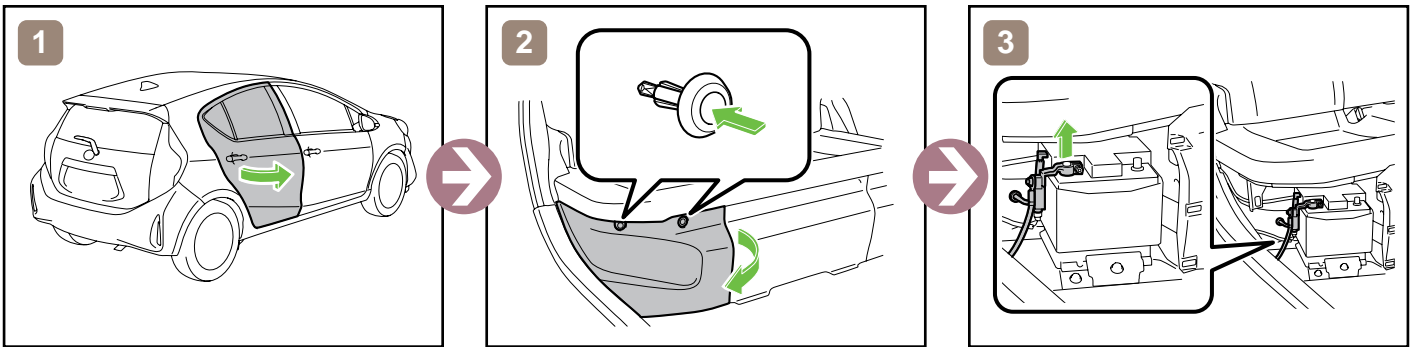

Towing Information

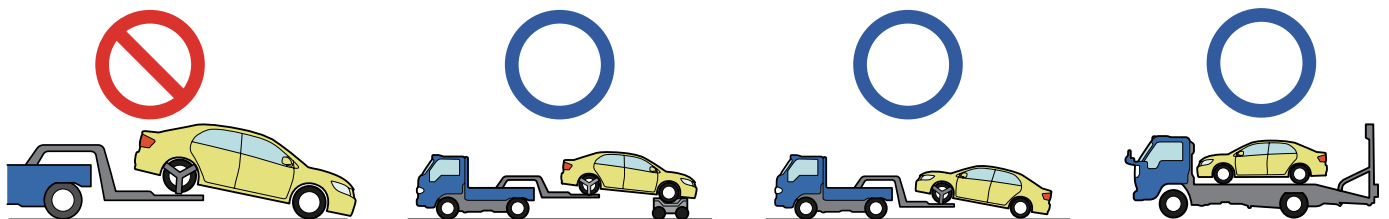









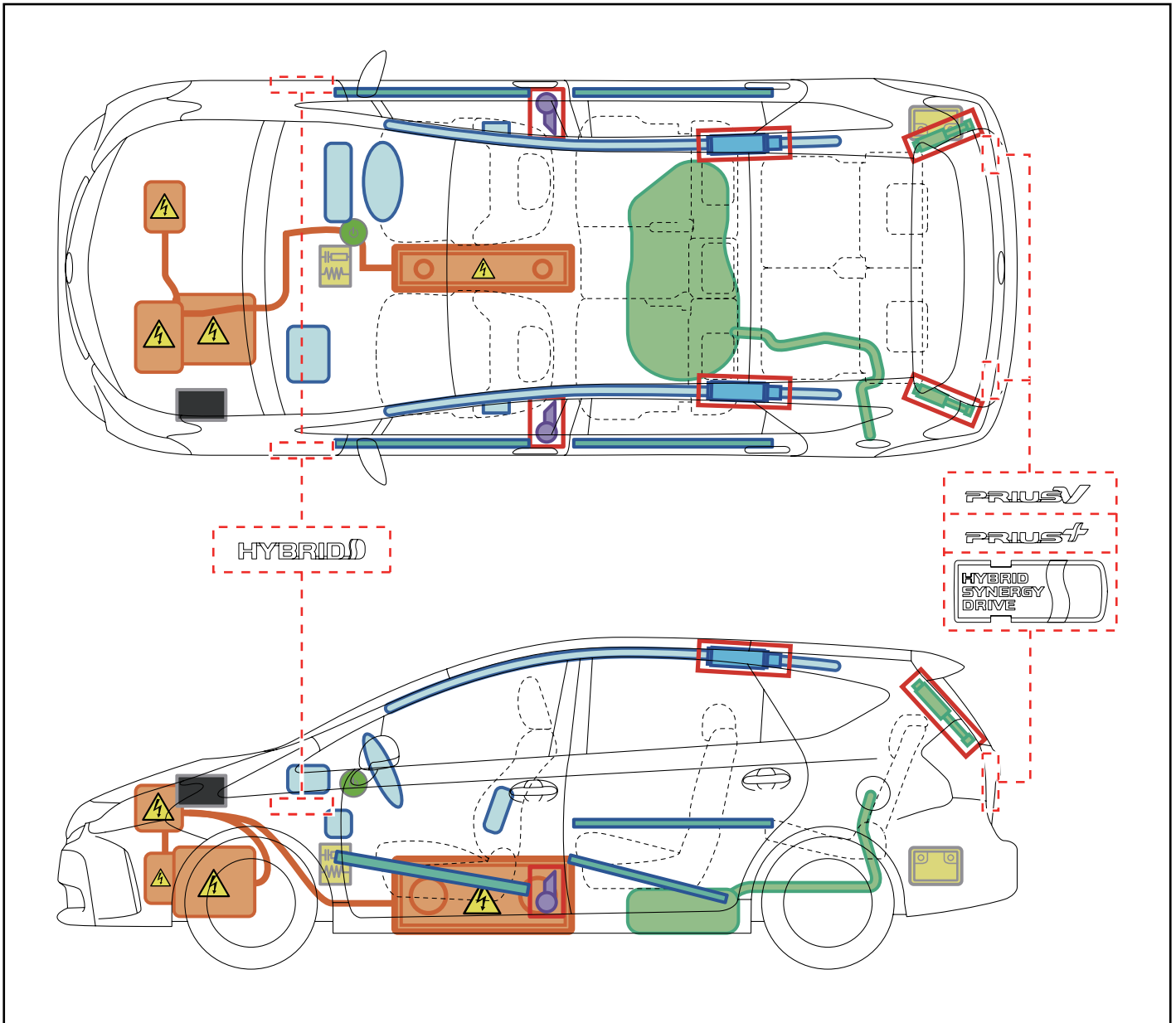
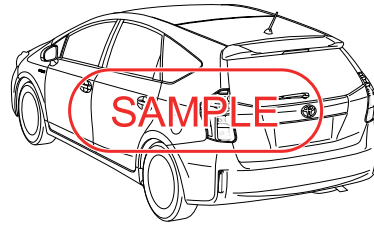
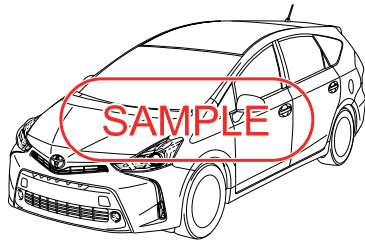



More details, please refer to "Emergency Response Guide".

PRIUS V / PRIUS +

RHD

2014-11



	IG/POWER SW		Fuse Box		12V Battery
	Airbag (incl. Inflator)		Inflator		High Voltage Battery
	High Voltage Components		Fuel Tank		Gas-filled Damper
	Seat Belt Pretensioner (Gas Generator)		Structural Reinforcements		Airbag Computer
-	-	-	-	-	-

Disable Vehicle

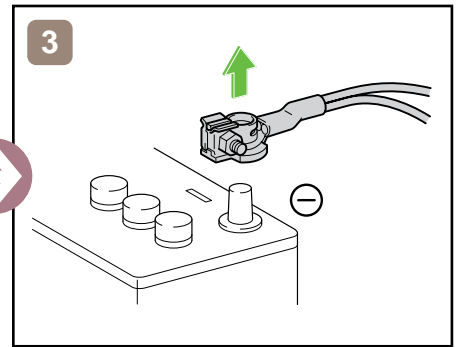
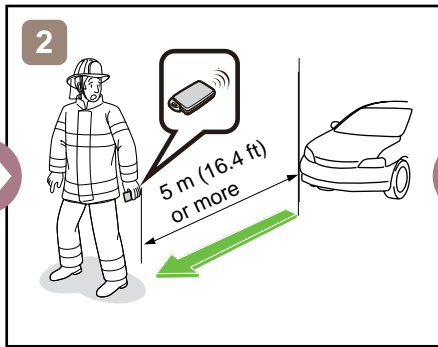
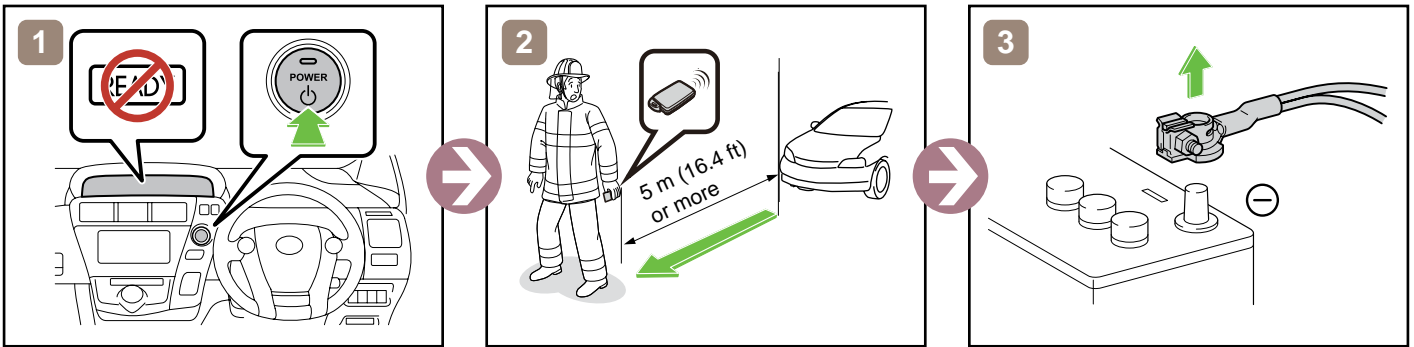

or

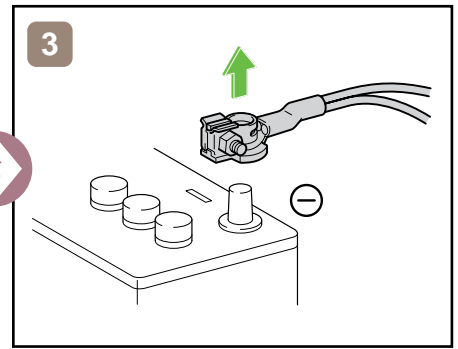
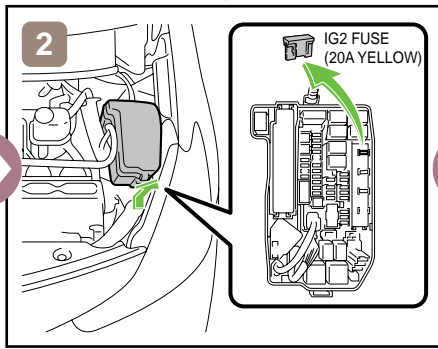
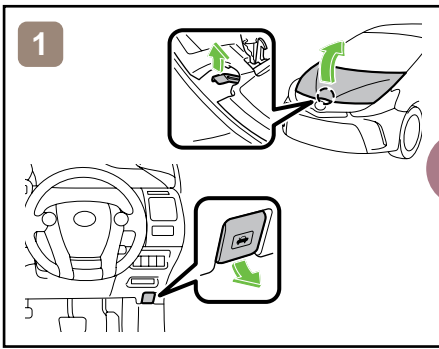

Access to 12V Battery

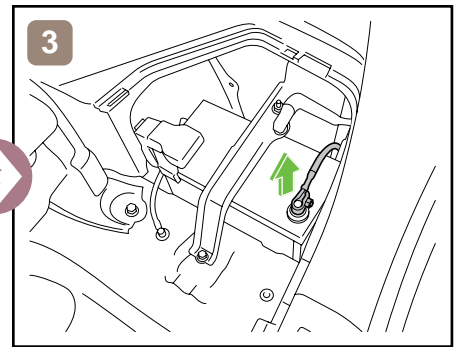
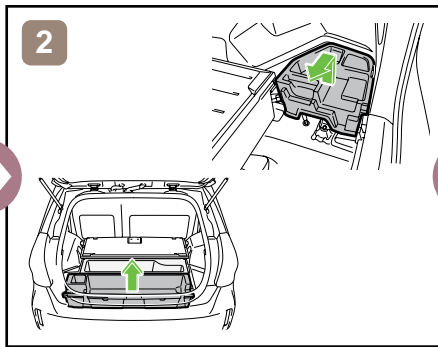
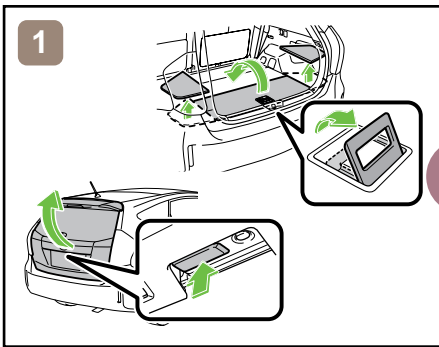

Towing Information

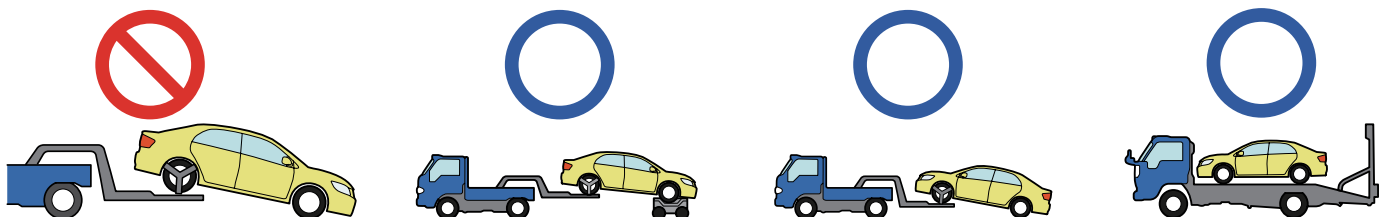

More details, please refer to "Emergency Response Guide".

RAV4

2013-9

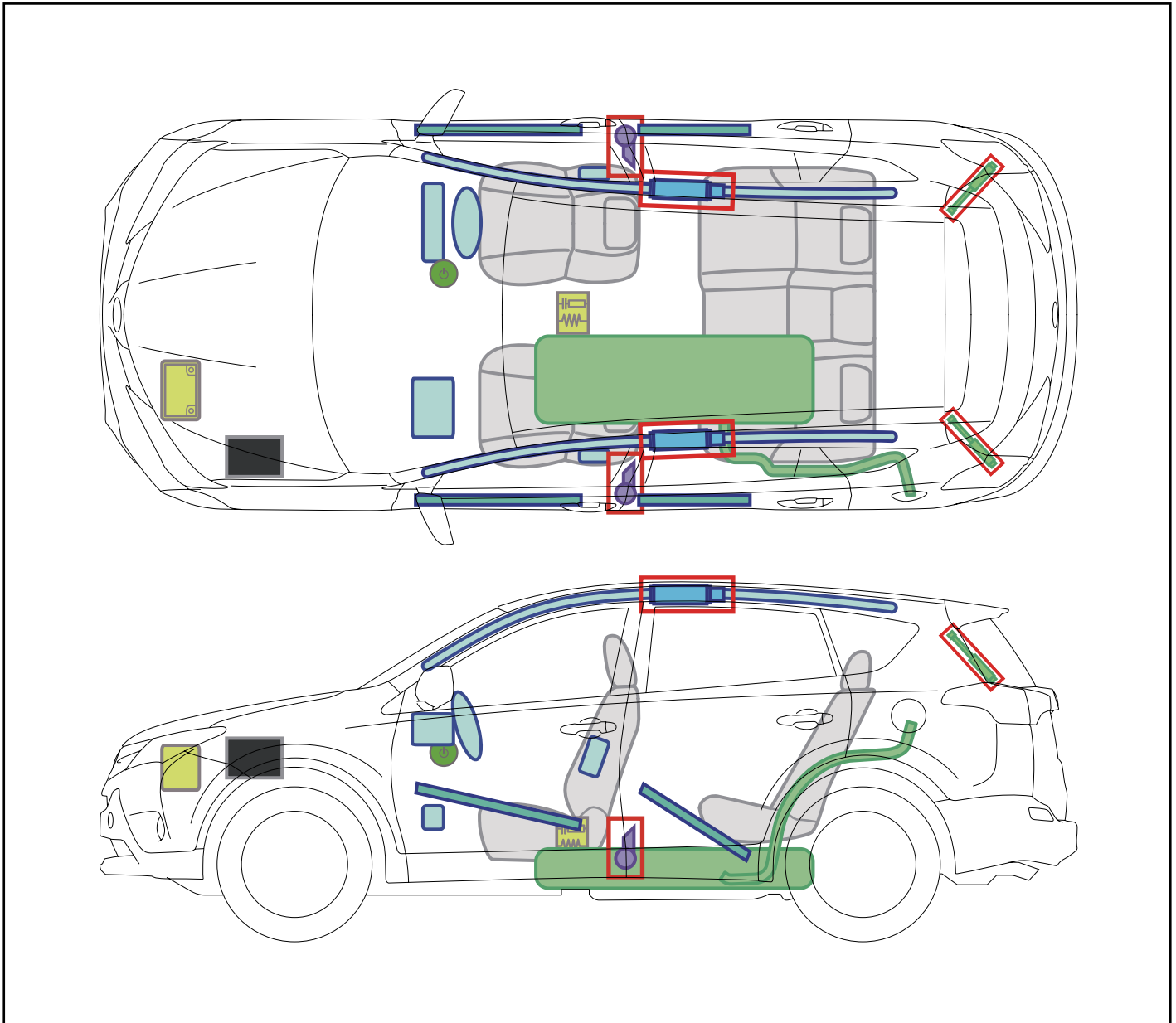

	IG/ENGINE SW		Fuse Box		12V Battery
	Airbag		Gas Generator		Fuel Tank
	Gas-filled Damper		Seat Belt Pretensioner		Structural Reinforcements
	Control Unit	—	—	—	—
—	—	—	—	—	—

Disable Vehicle

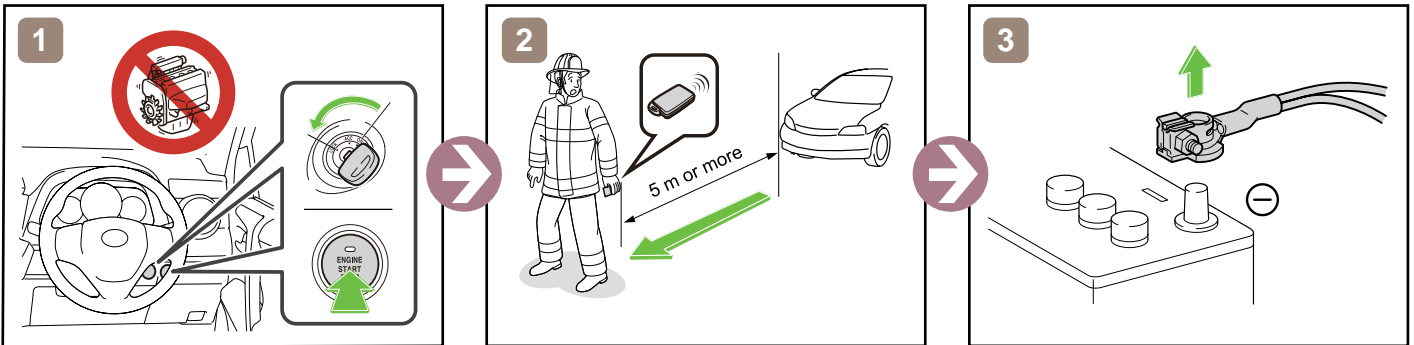

or

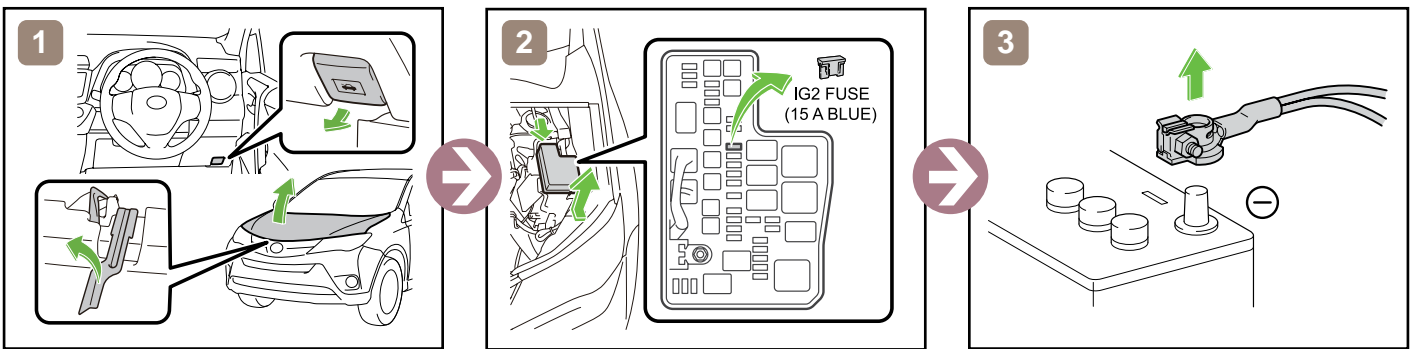

Access to 12V Battery

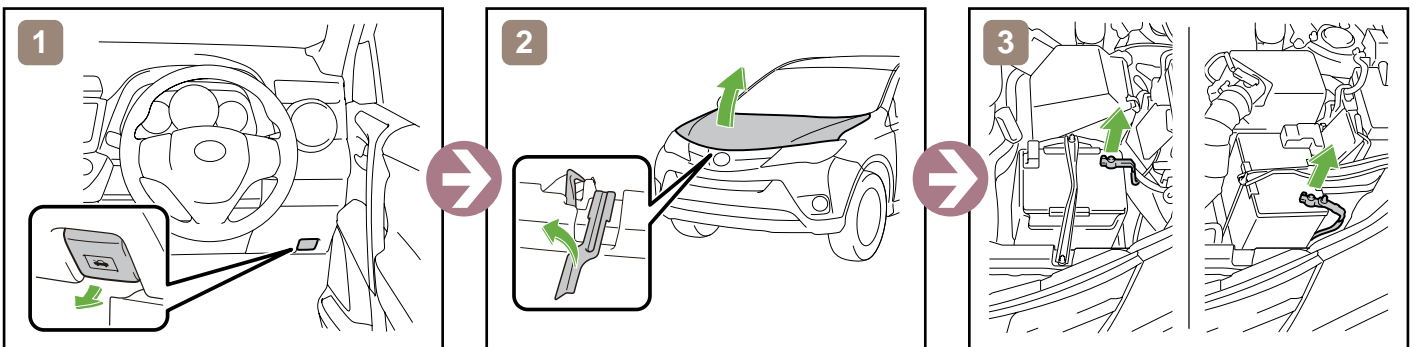

Towing Information

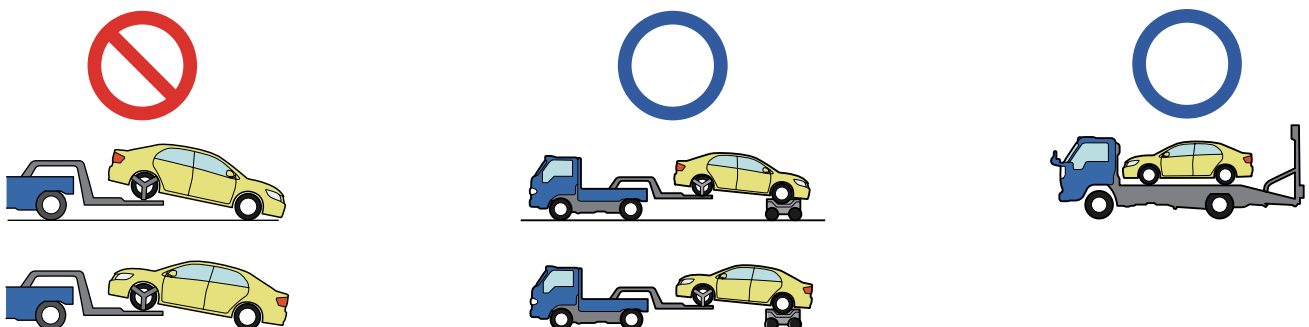

More details, please refer to "Emergency Response Guide".

RAV4
RHD

2018-11

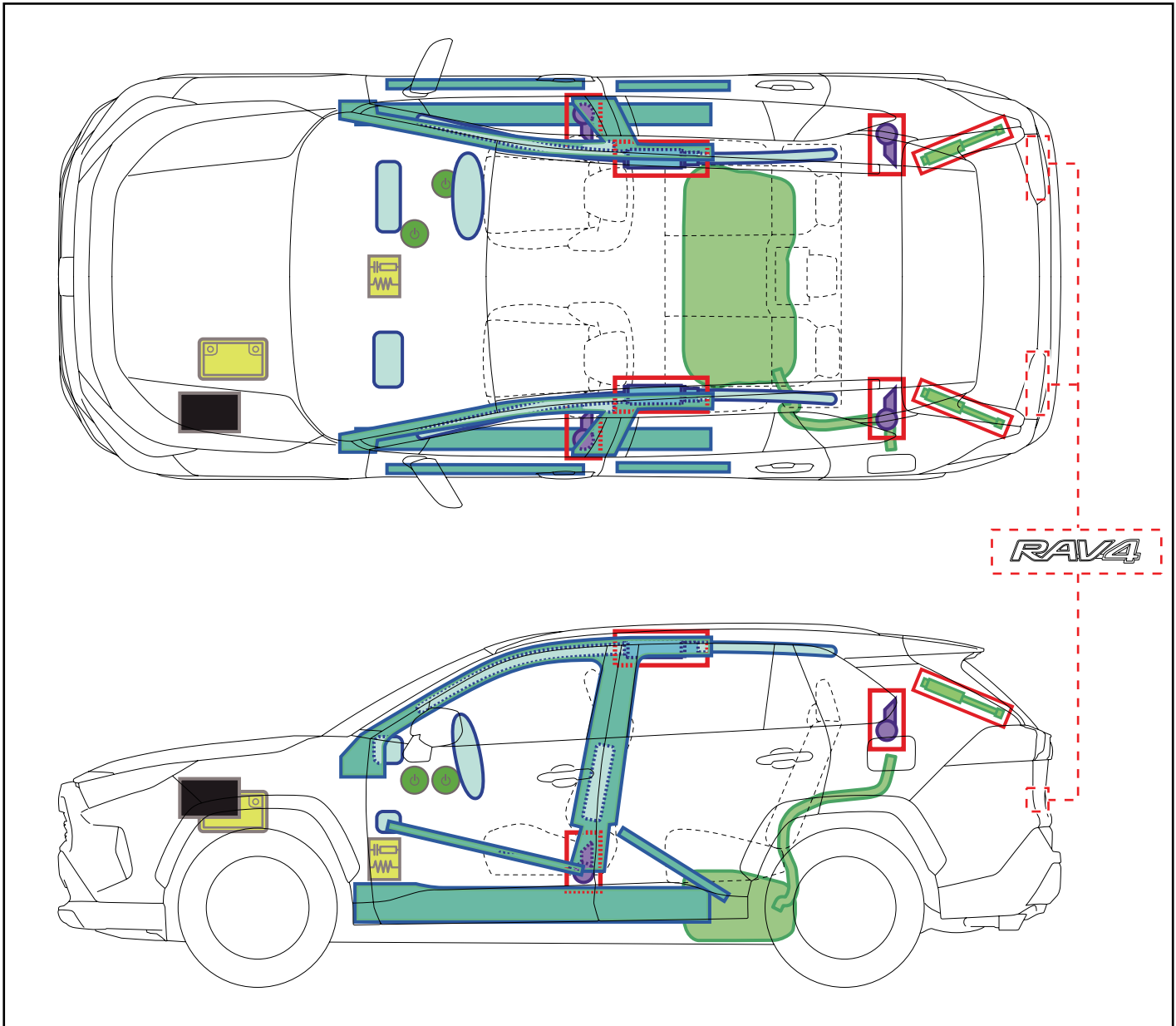
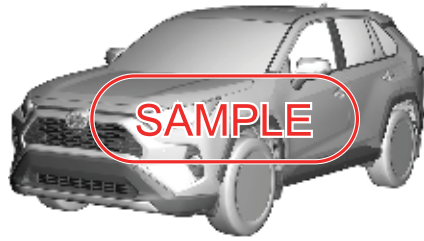

	IG/POWER SW		Fuse Box		12V Battery
	Airbag (incl. Inflator)		Inflator		Fuel Tank
	Gas-filled Damper		Seat Belt Pretensioner (Gas Generator)		Structural Reinforcements
	Airbag Computer	—	—	—	—
—	—	—	—	—	—

Disable Vehicle

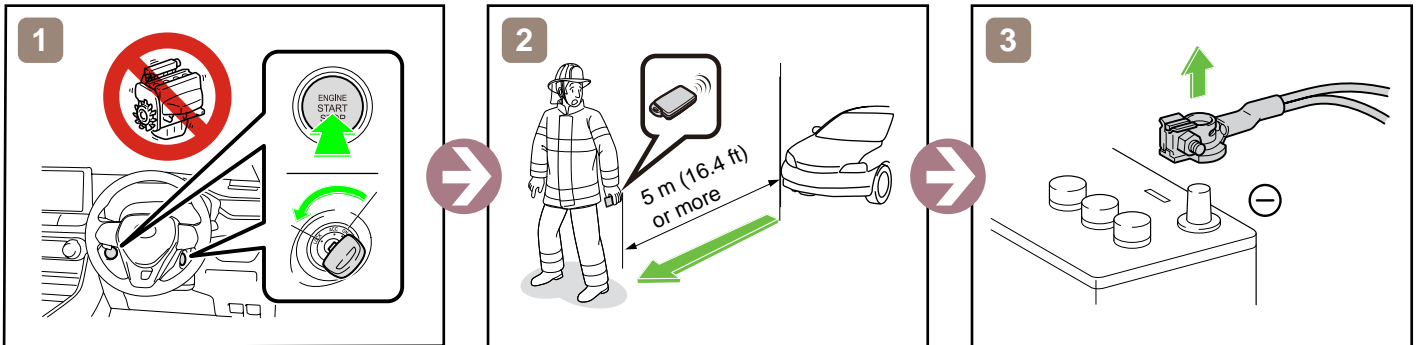

or

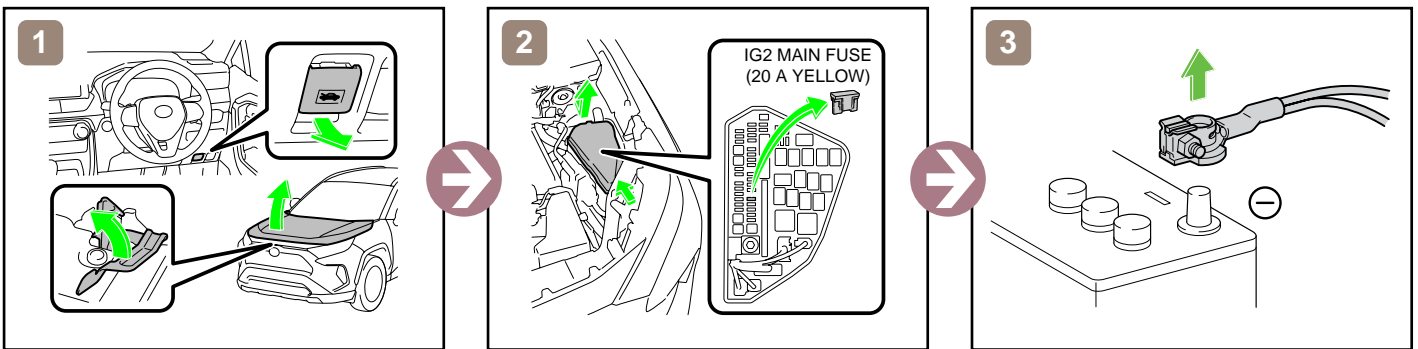

Access to 12V Battery

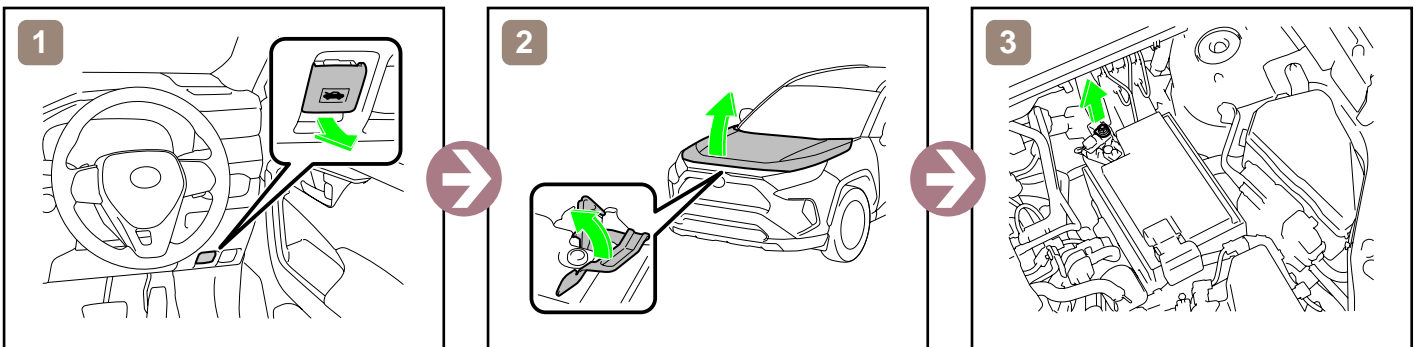

Towing Information

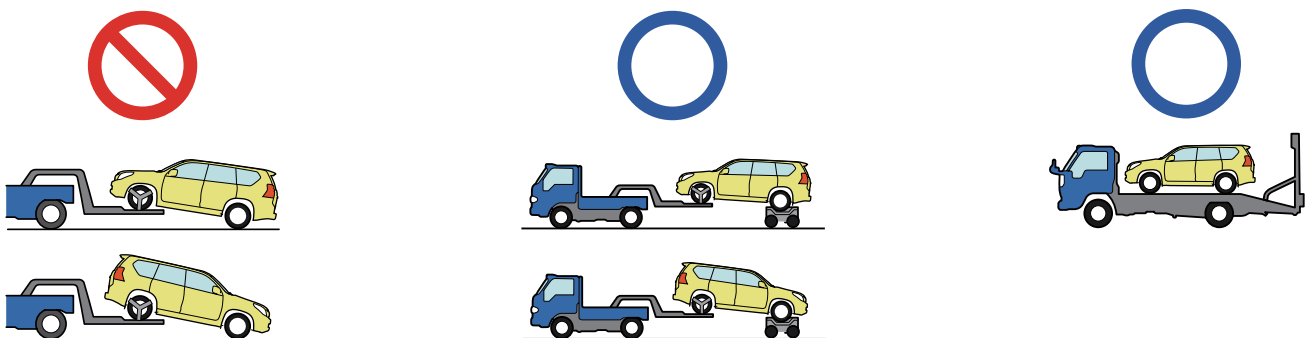

More details, please refer to "Emergency Response Guide".

RAV4
HYBRID
RHD
2018-11

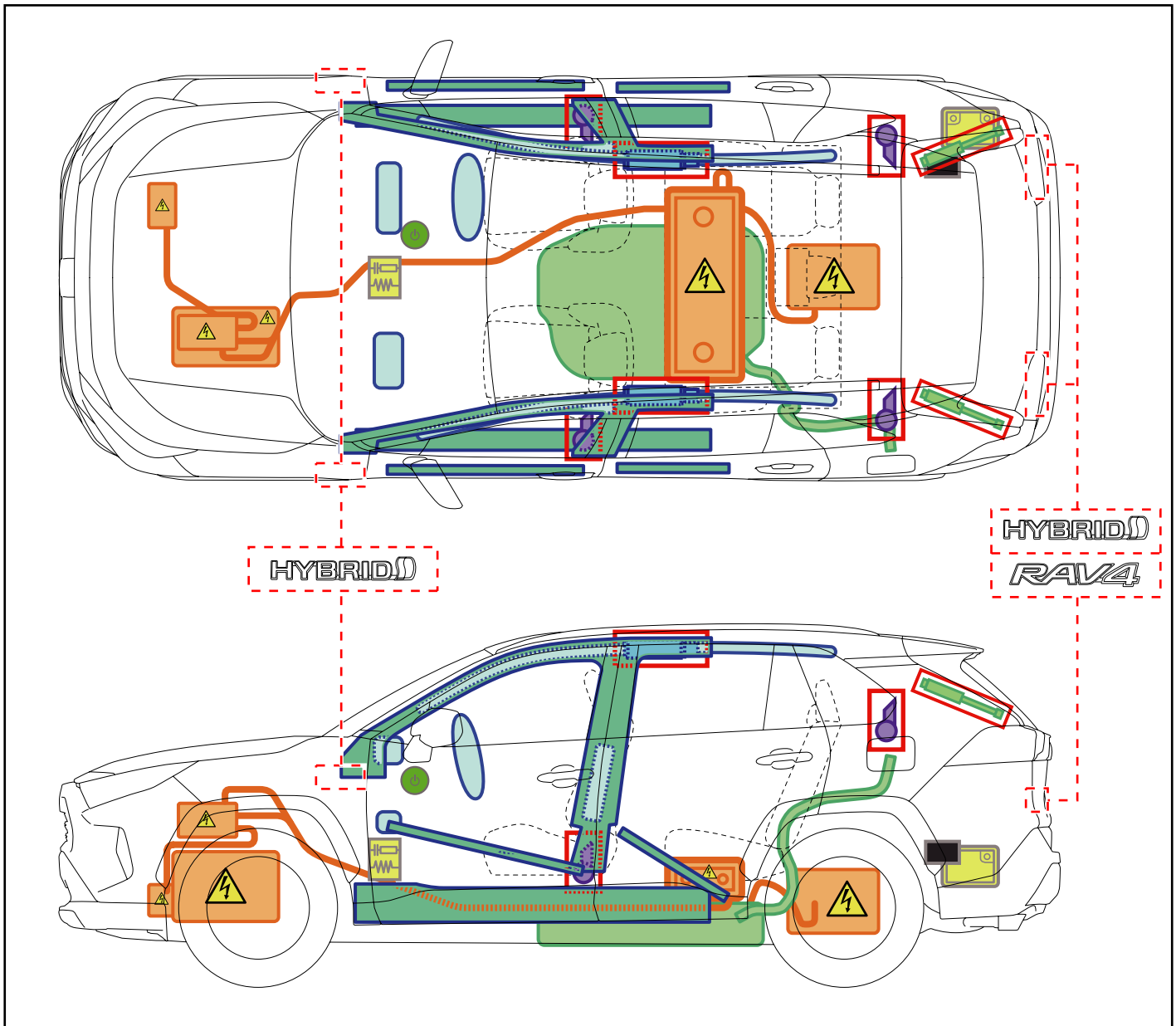
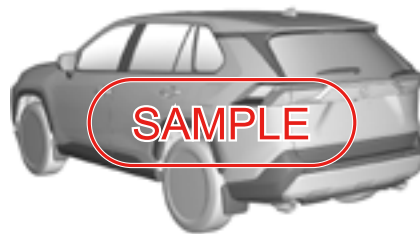

	IG/POWER SW		Fuse Box		12V Battery
	Airbag (incl. Inflator)		Inflator		High Voltage Battery
	High Voltage Components		Fuel Tank		Gas-filled Damper
	Seat Belt Pretensioner (Gas Generator)		Structural Reinforcements		Airbag Computer
—	—	—	—	—	—

Disable Vehicle

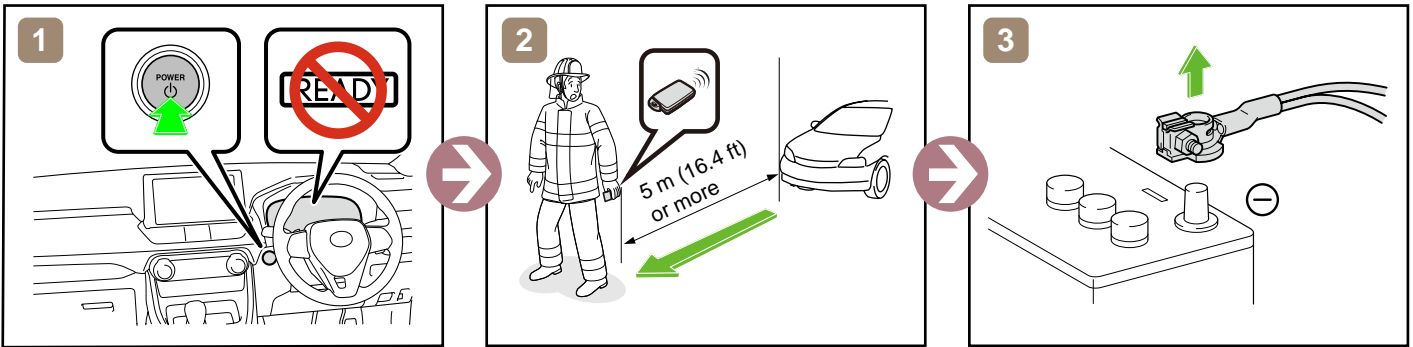

or

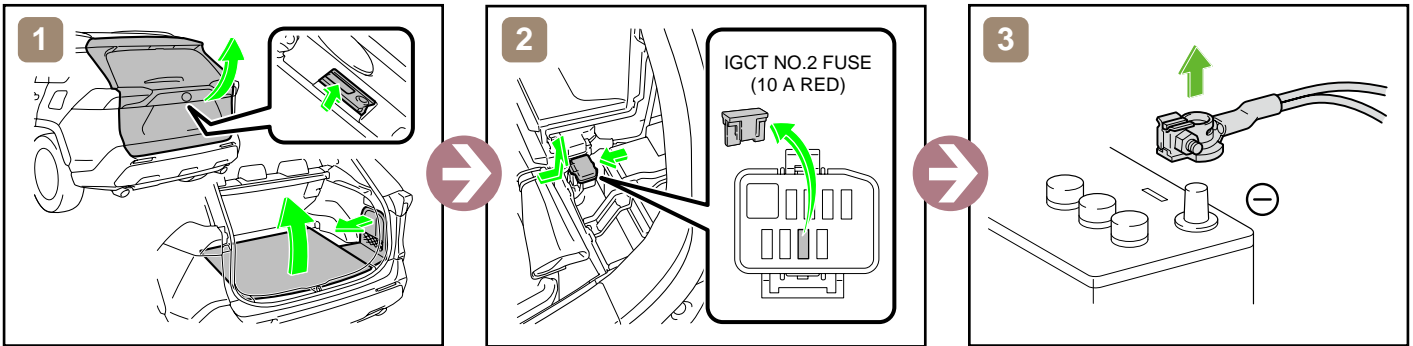

Access to 12V Battery

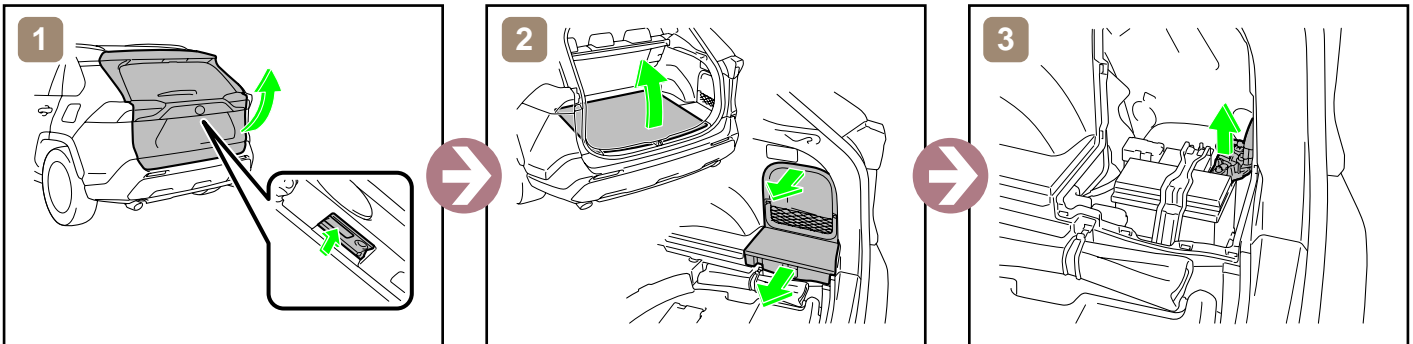

Towing Information

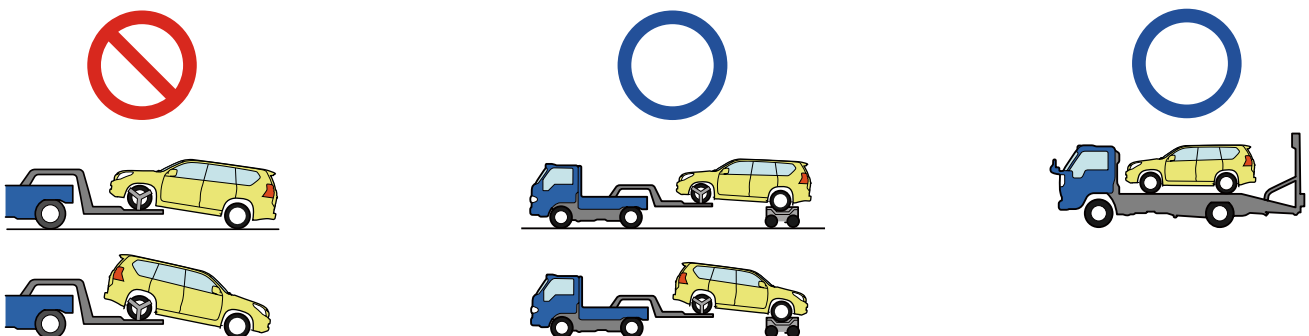

More details, please refer to "Emergency Response Guide".

SUPRA
RHD

2019-3

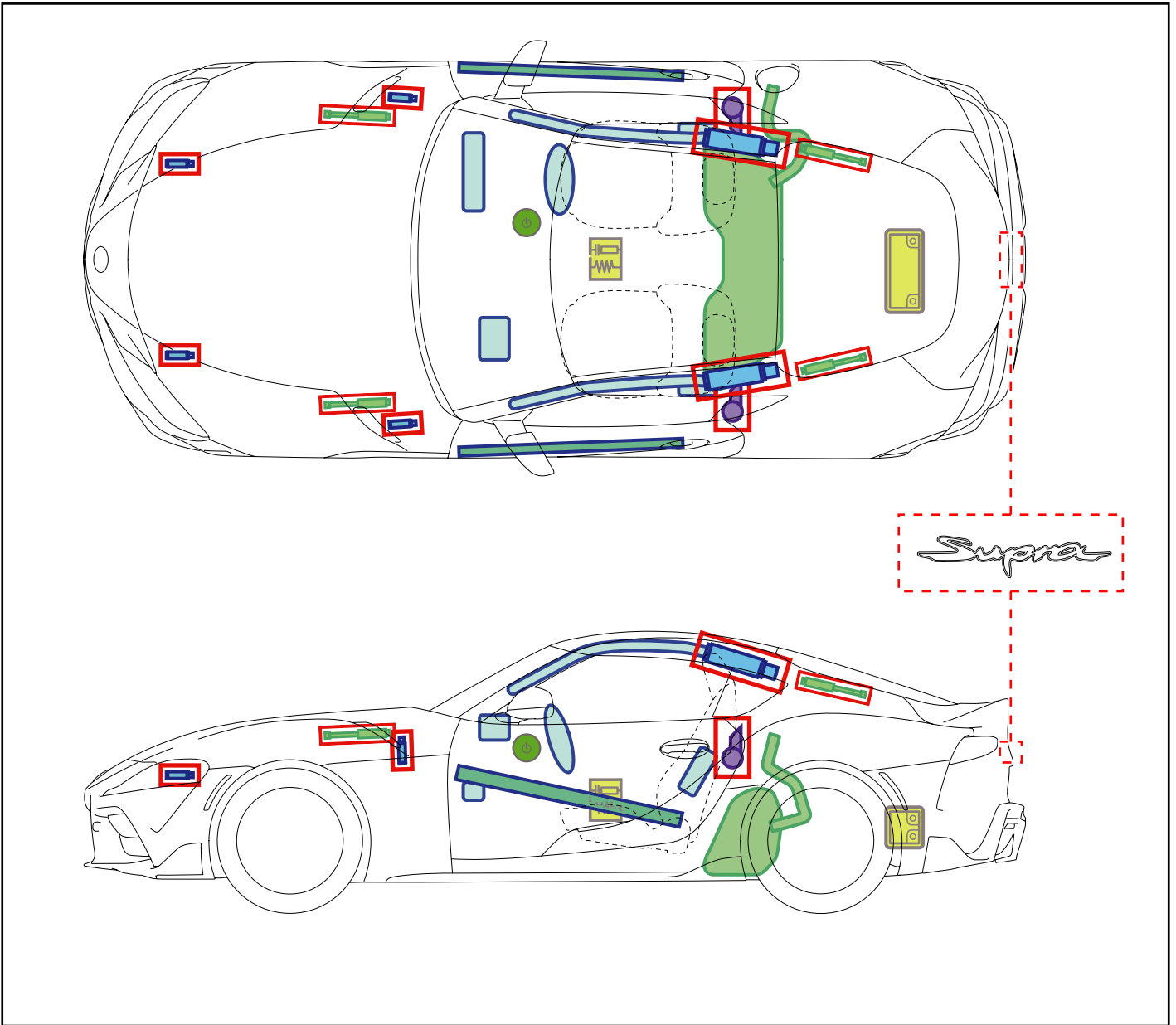

	IG/POWER SW		12V Battery		Airbag (incl. Inflator)
	Inflator		Fuel Tank		Gas-filled Damper
	Seat Belt Pretensioner (Gas Generator)		Structural Reinforcements		Airbag Computer

Disable Vehicle

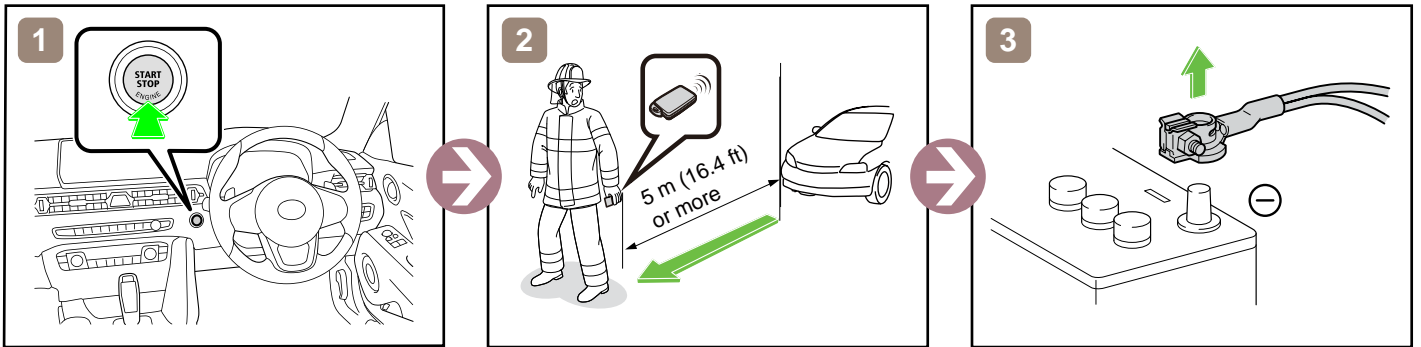

or

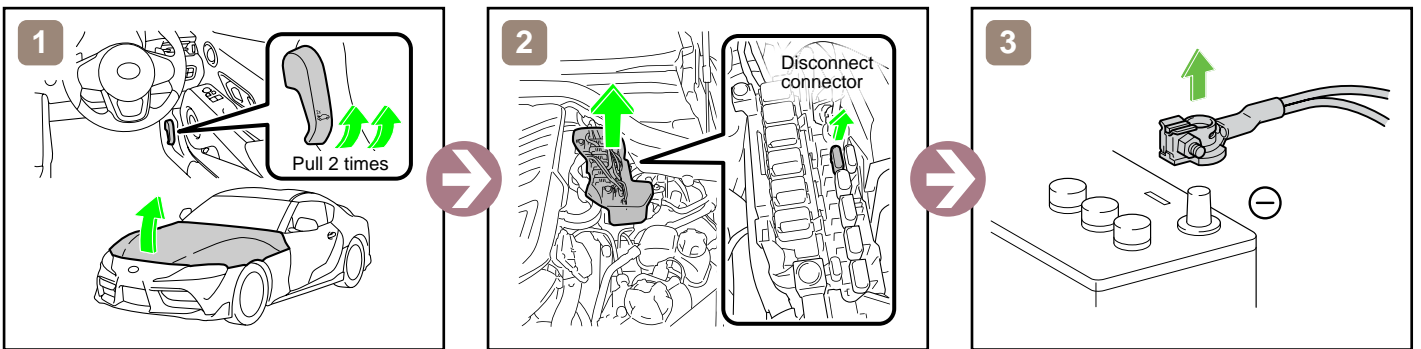

Access to 12V Battery

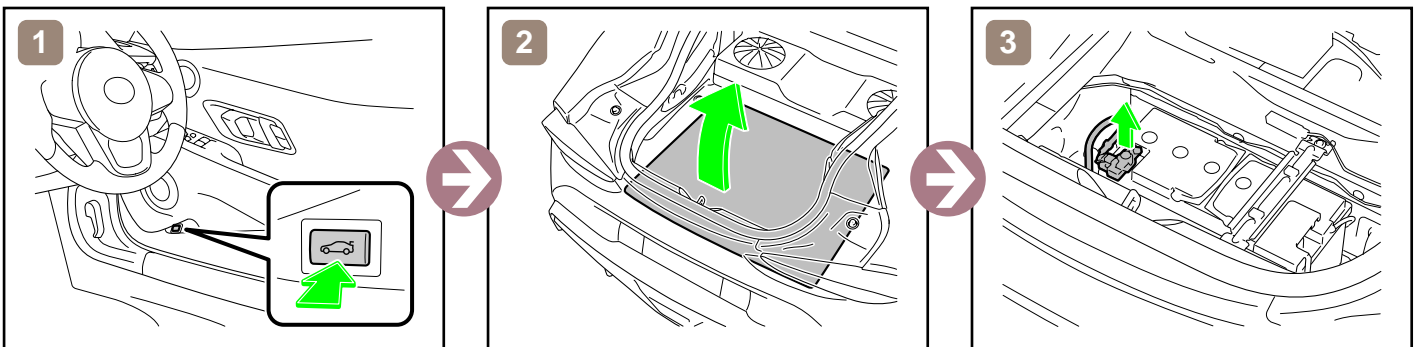

Towing Information

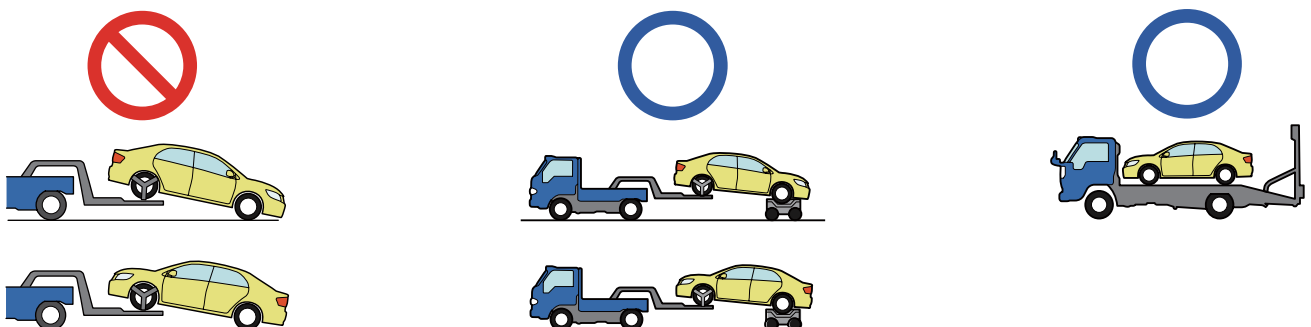







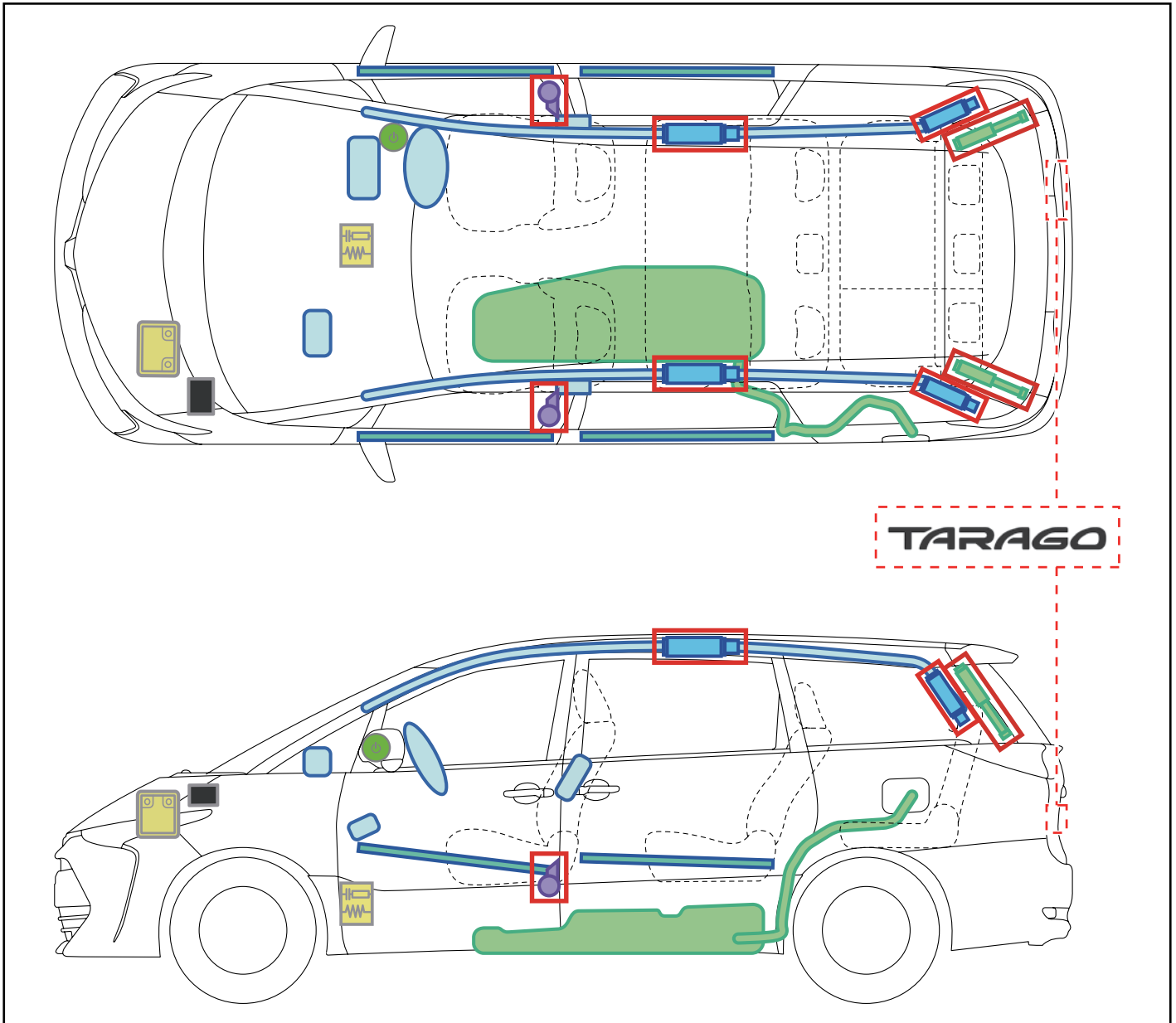
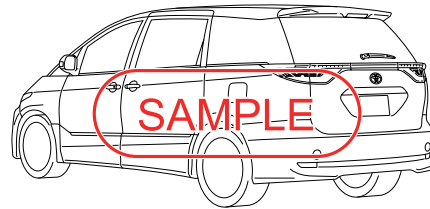
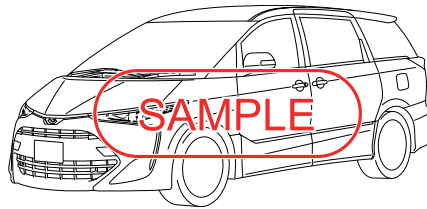



More details, please refer to "Emergency Response Guide".

TARAGO

2016-5



	ENGINE SW		Fuse Box		12V Battery
	Airbag (incl. Inflator)		Inflator		Fuel Tank
	Gas-filled Damper		Seat Belt Pretensioner (Gas Generator)		Structural Reinforcements
	Airbag Computer	—	—	—	—
—	—	—	—	—	—

Disable Vehicle

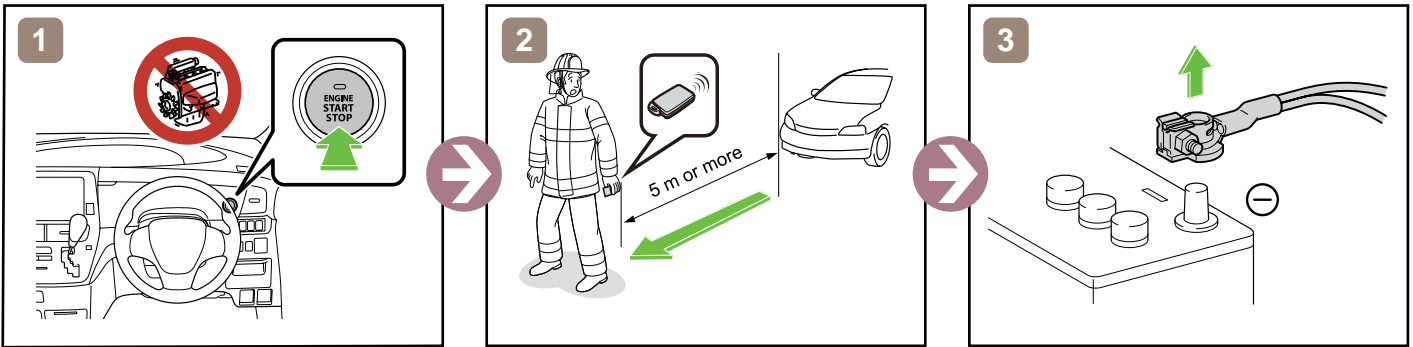

or

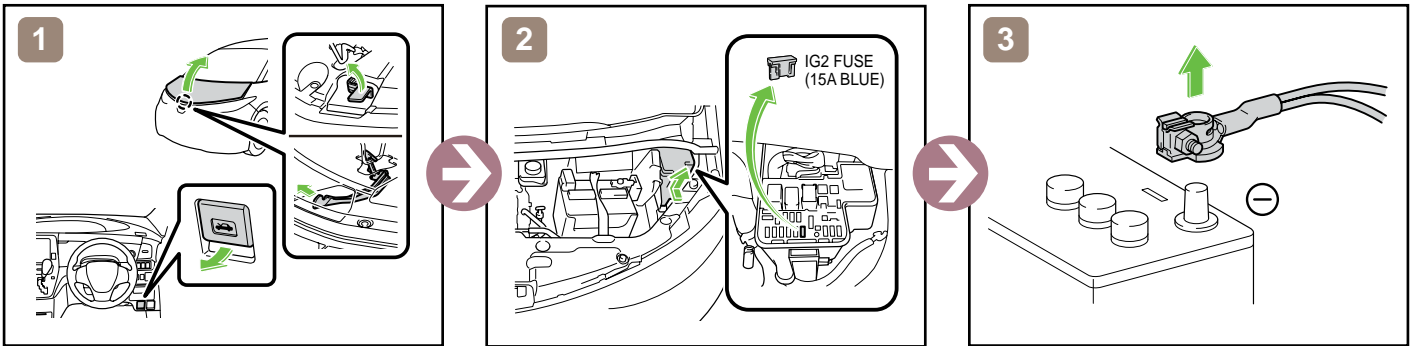

Access to 12V Battery

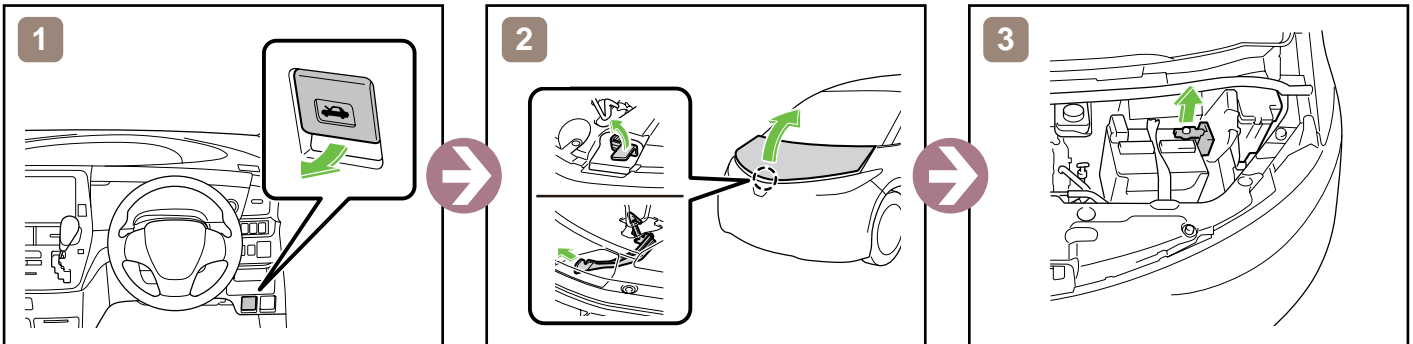

Towing Information

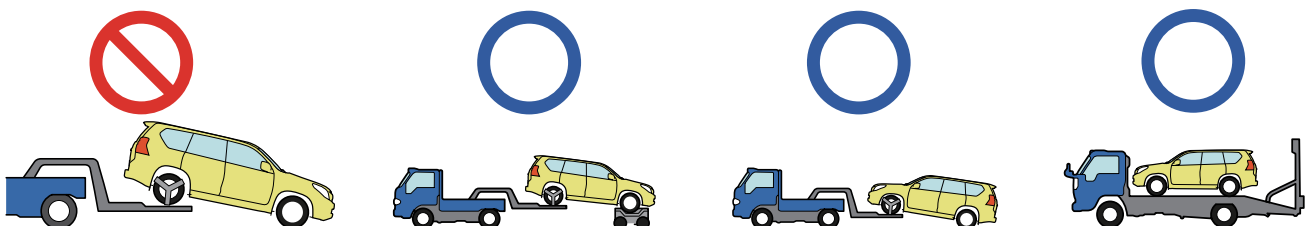

More details, please refer to "Emergency Response Guide".



TOYOTA TUNDRA
2023-5

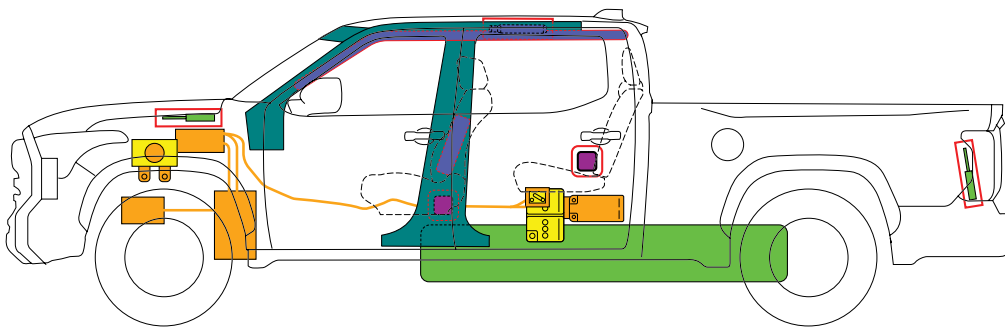
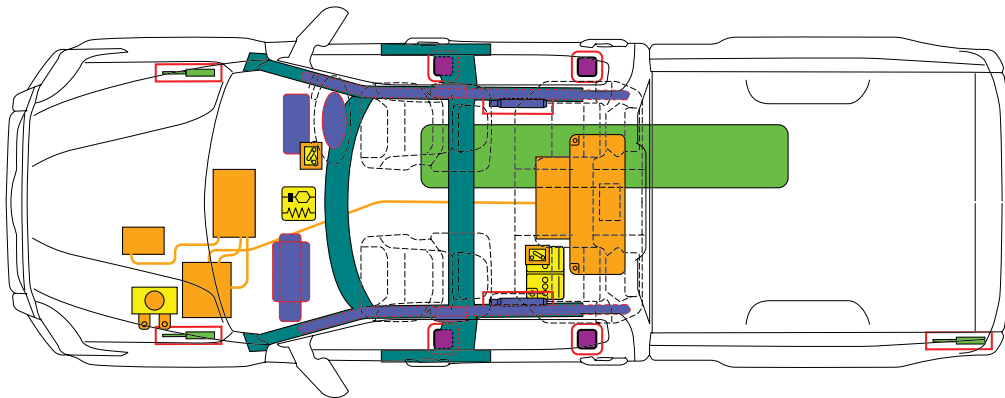

	Airbag		Stored gas inflator		Seat belt pretensioner		SRS Control Unit		Pedestrian protection active system
	Automatic rollover protection system		Gas strut / Preloaded spring		High strength zone		Zone requiring special attention		
	Battery low voltage		Ultra capacitor, low voltage		Fuel tank		Gas tank		Safety valve
	High voltage battery pack		High voltage power cable component		High voltage disconnect		Fuse box disabling high voltage system		Ultra capacitor, high voltage
	Low voltage device that disconnects high voltage		High voltage component						
		ID No.		Version No.		Version date		Page	
		TUNDRAHV70		01 - RHD		08 / 2023		1 / 4	

1. Identification / Recognition



Lack of engine noise does not mean vehicle is off. Silent movement or instant restart capability exists until vehicle is fully shut down.

■ Location of vehicle badges

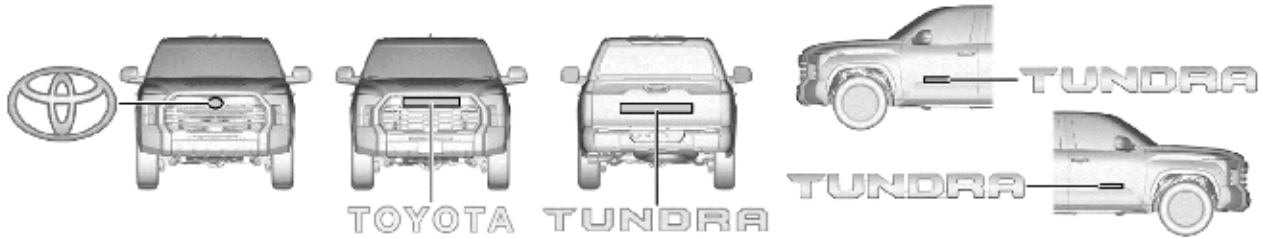

■ Energy source: Nickel-metal hydride Battery



2. Immobilisation / Stabilisation / Lifting

■ Completely immobilise the vehicle



1) Chock the wheels and engage the parking brake.

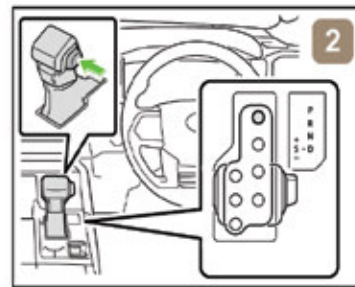

2) Move the shift lever to the (P) position.

■ Stabilisation-lifting point

Place cribbing such as wooden blocks at the four points under the front and rear pillars.

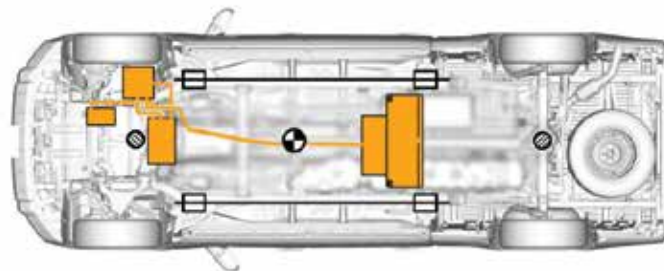

⊗ Extra Reinforced Lifting Points

□ Standard Jack Locations

⊙ Vehicle Centre of Gravity



Do not place cribbing such as wooden blocks or rescue air lifting bags under the exhaust system, fuel system or high voltage power cables. Doing so may result in fuel leaks, fire or electric shock.

ID No.	Version No.	Version date	Page
TUNDRAHV70	01 - RHD	08 / 2023	2 / 4

3. Disable direct hazards / Safety regulations

- If any of the following systems are required to be operated, operate them BEFORE disconnecting the battery.

Power door lock

Power window

Electric parking brake

Power tilt and telescopic steering

Power seat

Panoramic moon roof



When the 12 V battery is disconnected, electrical components cannot be operated

- Perform procedure Main or Alternative to completely shut off the vehicle.

<Procedure Main>

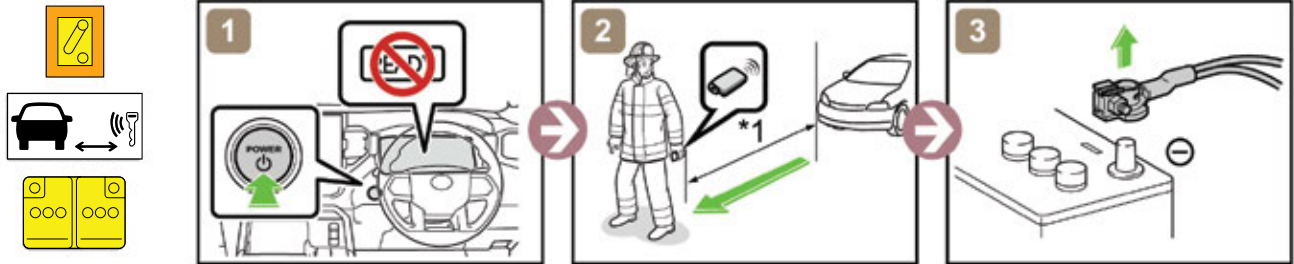

*1: 5 m (16.4 ft) or more

<Procedure Alternative>

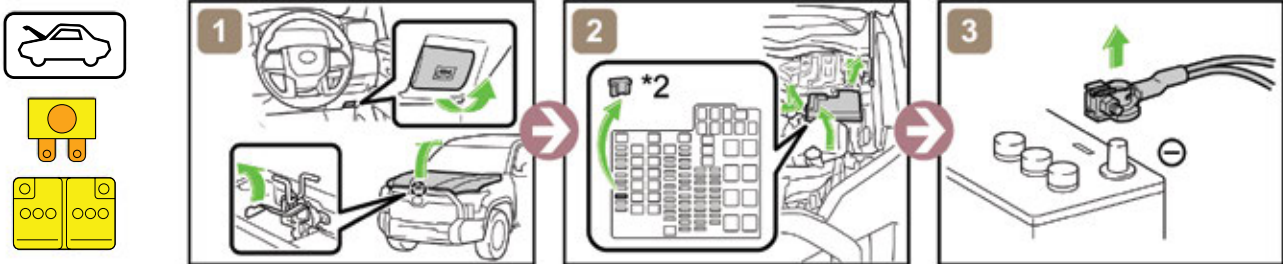

*2: EFI NO.2 FUSE (7.5 A BROWN)

- Access to 12 V Battery

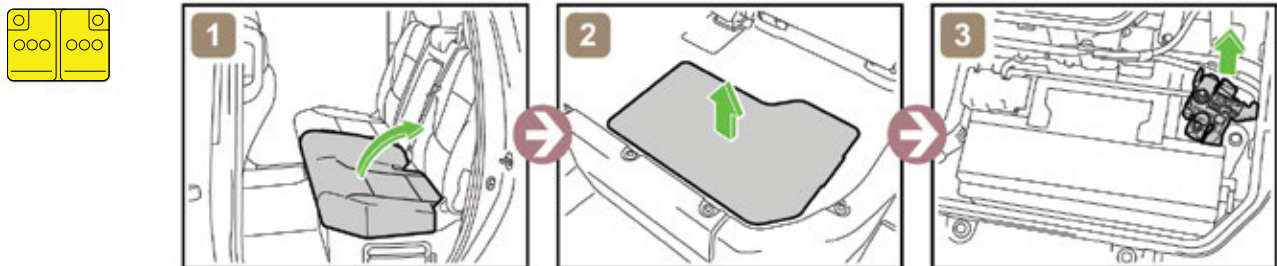

4. Access to the occupants

- Window Glass

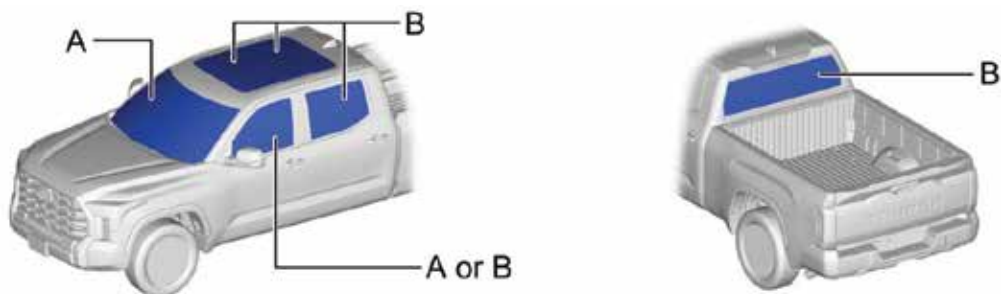

A	Laminated	B	Tempered
---	-----------	---	----------

ID No.	Version No.	Version date	Page
TUNDRAHV70	01 - RHD	08 / 2023	3 / 4

5. Stored energy / Liquids / Gases / Solids



High Voltage Ni-MH Battery



12 V Battery



Petrol Tank: 122 L



- Always wear appropriate personal protective equipment (PPE) when dealing with any of these items.
- Never breach or remove the battery assembly cover under any circumstances, including fire. Doing so may result in serious injury or death from severe burns or electric shock

6. In case of fire



USE COPIOUS AMOUNTS OF WATER

If it is difficult to apply copious amounts of water to the high voltage battery, it is recommended to allow the high voltage battery to burn itself out.

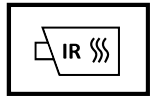

RE-IGNITION POSSIBLE !



7. In case of submersion



Do not touch any of the high-voltage components or cables, including the service plug, while the vehicle is submerged. Doing so may result in electric shock.
Work on the vehicle only after the vehicle has been pulled out of the water.

8. Towing / Transportation / Storage

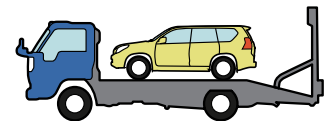
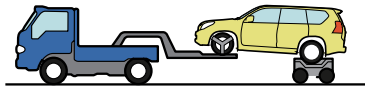

RE-IGNITION POSSIBLE !

Store the vehicle at a safe distance (15 m (49.2 ft) or more) from other vehicles.

9. Important additional information

For further details, please refer to "Emergency Response Guide".

ID No.	Version No.	Version date	Page
TUNDRAHV70	01 - RHD	08 / 2023	4 / 4



TOYOTA TUNDRA
4 doors / 5 seats / pick-up
2025-08

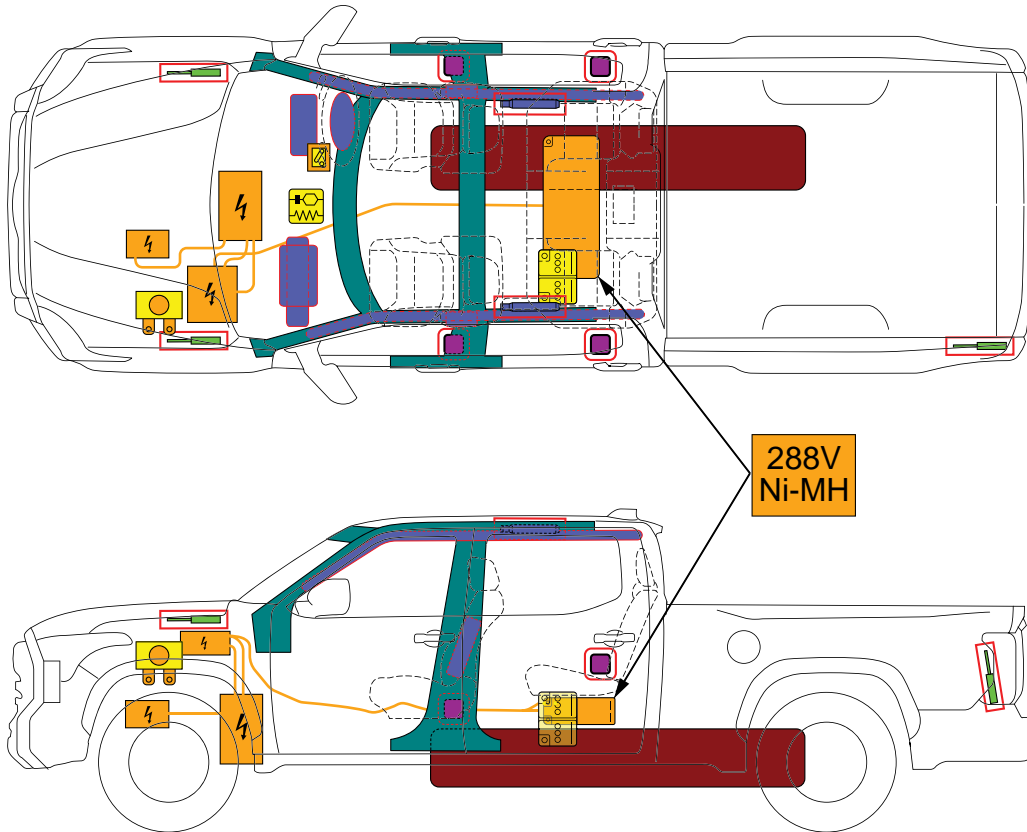

288V
Ni-MH

	Airbag		Stored gas inflator		Seat belt pretensioner		SRS Control Unit		
	Gas strut / Preloaded spring		High strength zone						
	Battery low voltage		Fuel tank						
	High voltage battery pack		High voltage power cable component		High voltage component		Fuse box disabling high voltage system		
	ID No.	Version No.		Version date		Page			
	TUNDRAHV70	01 - RHD		08 / 2025		1 / 4			

1. Identification / Recognition



LACK OF ENGINE NOISE DOES NOT MEAN VEHICLE IS OFF. SILENT MOVEMENT OR INSTANT RESTART CAPABILITY EXISTS UNTIL VEHICLE IS FULLY SHUT DOWN.

■ Location of vehicle badges

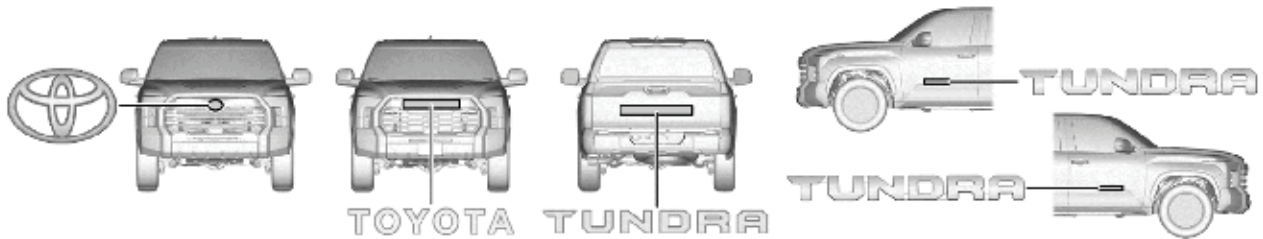

■ Energy source: Nickel-metal hydride Battery



2. Immobilisation / Stabilisation / Lifting

■ Completely immobilise the vehicle



1) Chock the wheels and engage the parking brake.

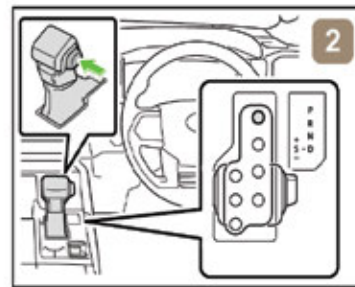

2) Move the shift lever to the (P) position.

■ Stabilisation-lifting point

Place cribbing such as wooden blocks at the four points under the front and rear pillars.

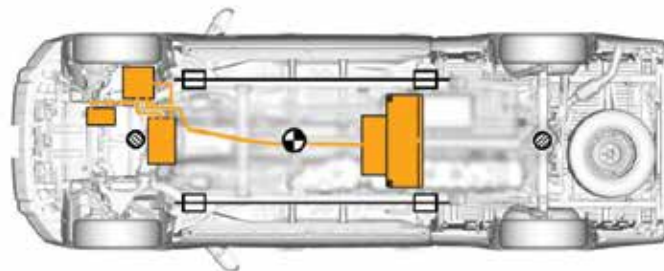

⊗ Extra Reinforced Lifting Points

□ Standard Jack Locations

⊕ Vehicle Centre of Gravity



Do not place cribbing such as wooden blocks or rescue air lifting bags under the exhaust system, fuel system or high voltage power cables. Doing so may result in fuel leaks, fire or electric shock.

ID No.	Version No.	Version date	Page
TUNDRAHV70	01 - RHD	08 / 2025	2 / 4

3. Disable direct hazards / Safety regulations

■ If any of the following systems are required to be operated, operate them BEFORE disconnecting the battery.

Power door lock

Power window

Electric parking brake

Power tilt and telescopic steering

Power seat

Panoramic moon roof

When the 12 V battery is disconnected, electrical components cannot be operated

■ Perform procedure Main or Alternative to completely shut off the vehicle.

<Main Procedure>

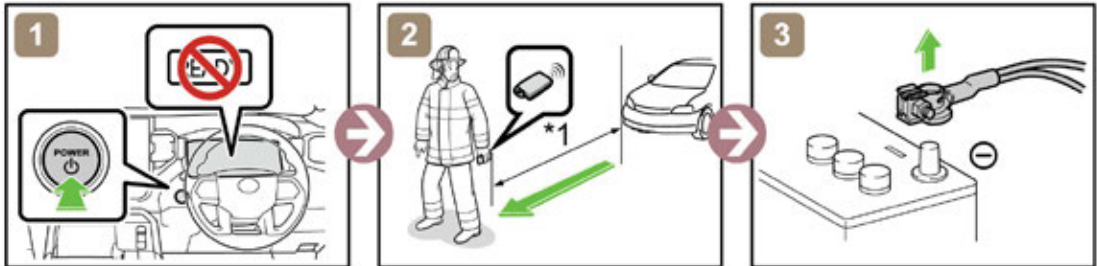
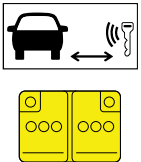

*1: 5 m (16.4 ft) or more

<Alternative Procedure>

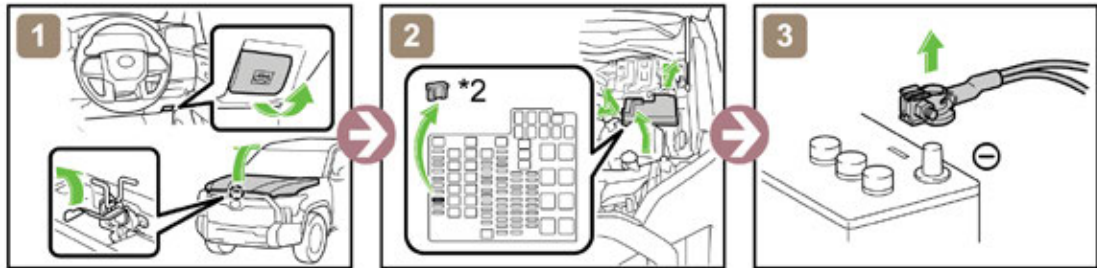
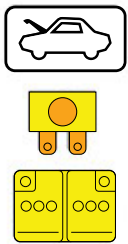

*2: EFI NO.2 FUSE (7.5 A BROWN)

■ Access to 12 V Battery

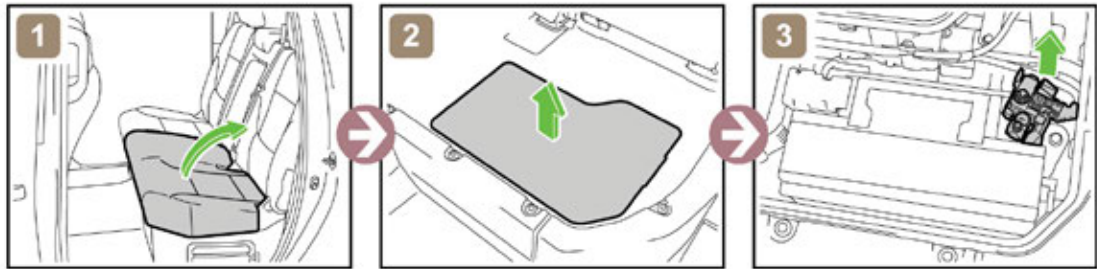
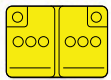

4. Access to the occupants

■ Window Glass

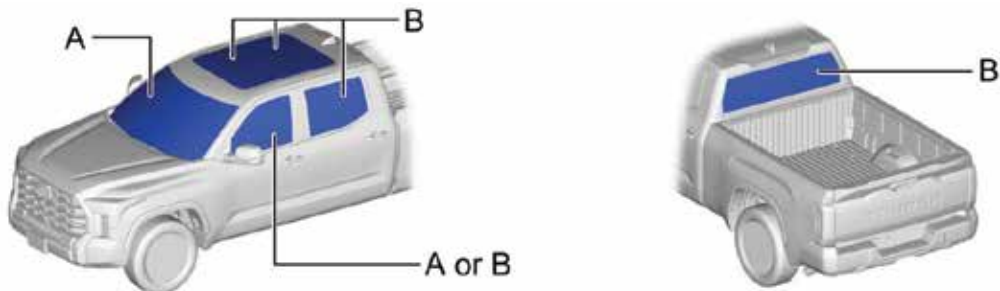

A	Laminated	B	Tempered
---	-----------	---	----------

ID No.	Version No.	Version date	Page
TUNDRAHV70	01 - RHD	08 / 2025	3 / 4

5. Stored energy / Liquids / Gases / Solids



High Voltage Ni-MH Battery



12 V Battery



Petrol Tank: 122 L



- Always wear appropriate personal protective equipment (PPE) when dealing with any of these items.
- Never breach or remove the battery assembly cover under any circumstances, including fire. Doing so may result in serious injury or death from severe burns or electric shock

6. In case of fire



USE COPIOUS AMOUNTS OF WATER

If it is difficult to apply copious amounts of water to the high voltage battery, it is recommended to allow the high voltage battery to burn itself out.

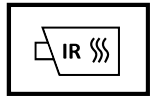

RE-IGNITION POSSIBLE !

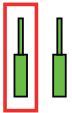

Gas strut / Preloaded spring

As it is possible for a gas strut / preloaded spring to become a projectile, refer to the component layout drawing.

7. In case of submersion



Do not touch any of the high-voltage components or cables, including the service plug, while the vehicle is submerged. Doing so may result in electric shock.
Work on the vehicle only after the vehicle has been pulled out of the water.

8. Towing / Transportation / Storage

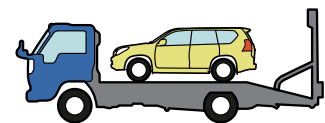

RE-IGNITION POSSIBLE !

Store the vehicle at a safe distance (15 m (49.2 ft) or more) from other vehicles.

9. Important additional information

For further details, please refer to "Emergency Response Guide".

ID No.	Version No.	Version date	Page
TUNDRAHV70	01 - RHD	08 / 2025	4 / 4

YARIS

3 DOOR

2014-7

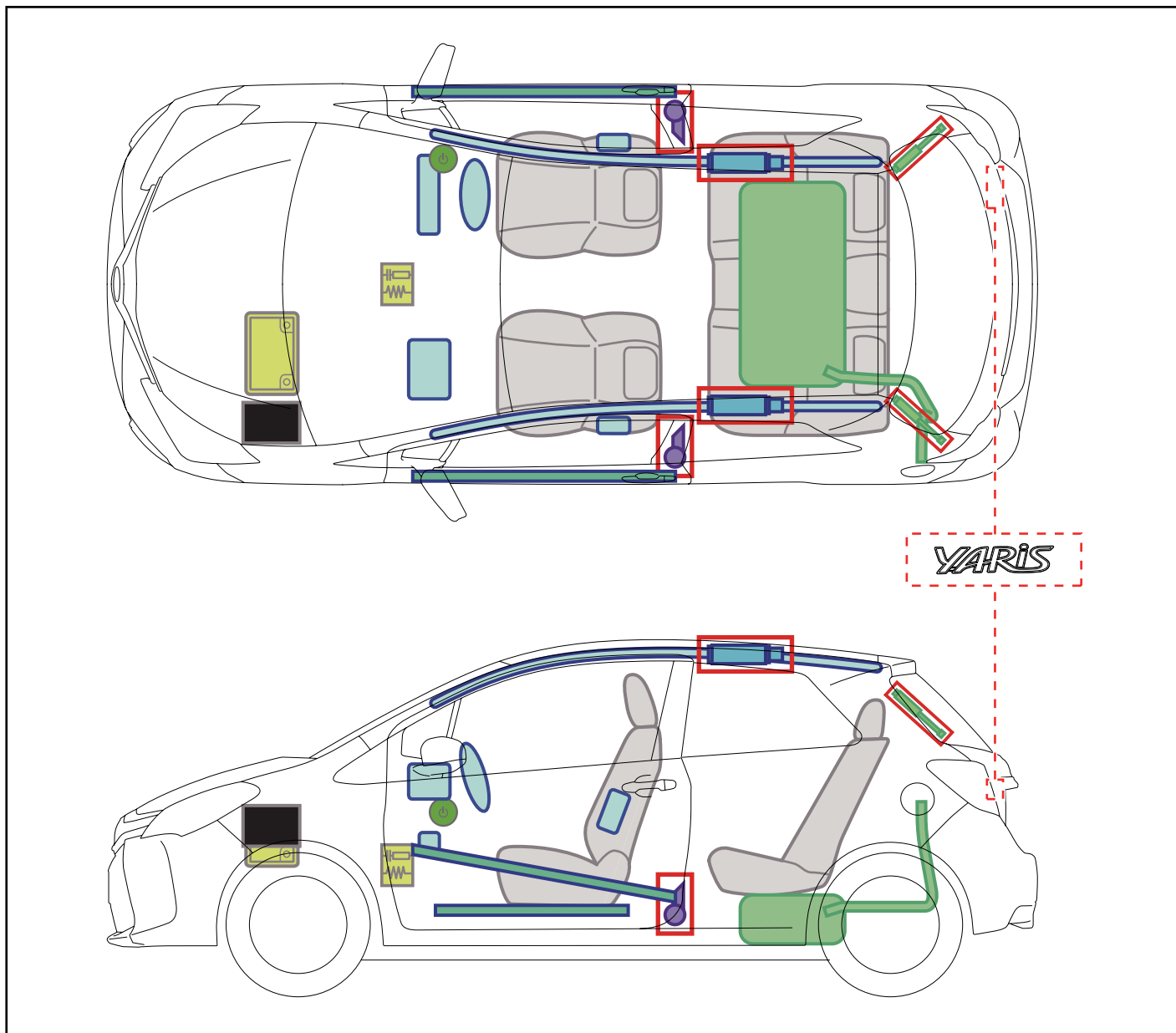
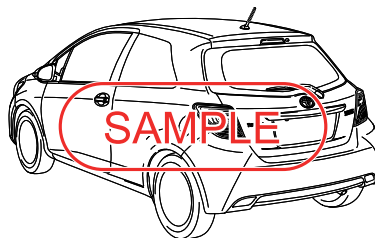
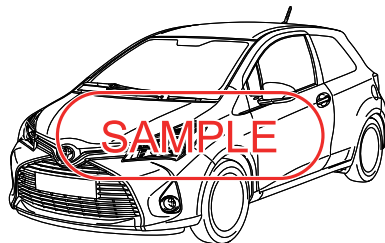

	IG/ENGINE SW		Fuse Box		12V Battery
	Airbag (incl. Inflator)		Inflator		Fuel Tank
	Gas-filled Damper		Seat Belt Pretensioner (Gas Generator)		Structural Reinforcements
	Airbag Computer	—	—	—	—
—	—	—	—	—	—

Disable Vehicle

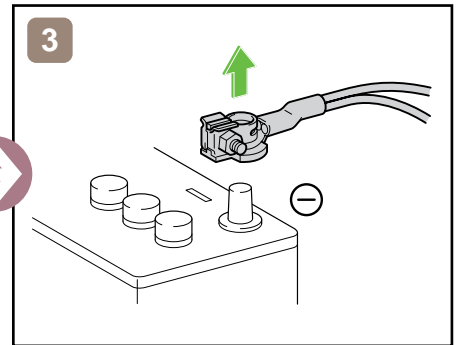
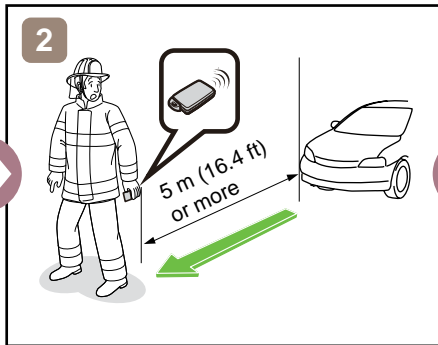
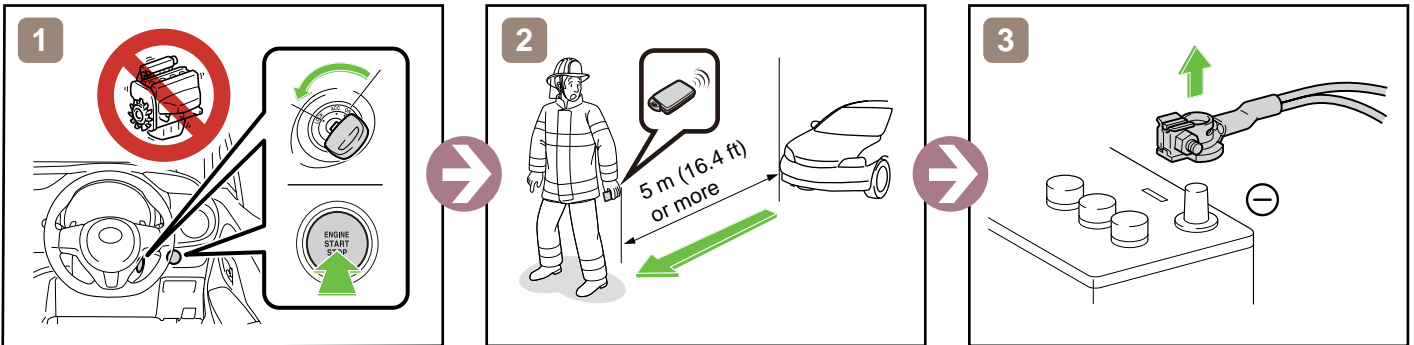

or

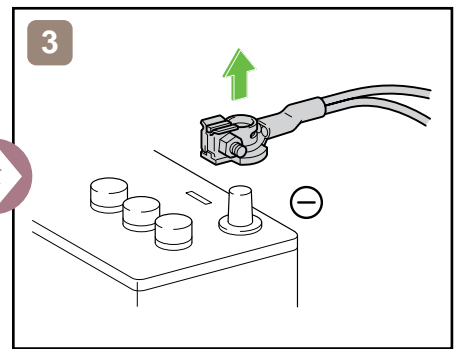
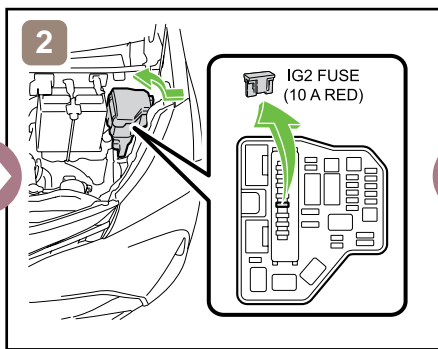
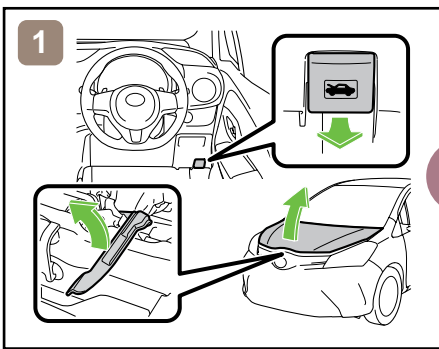

Access to 12V Battery

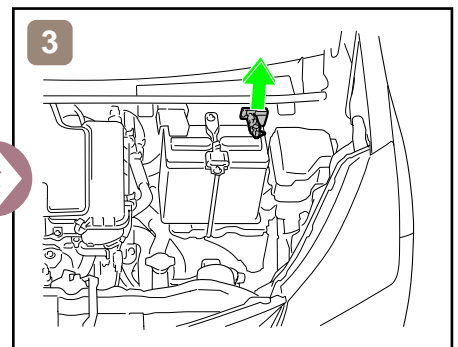
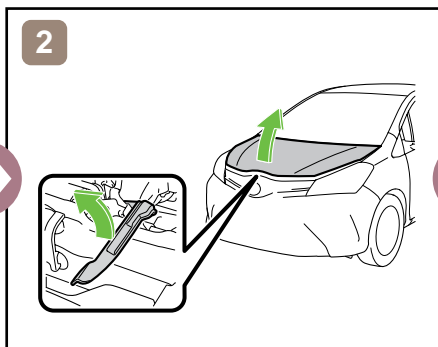
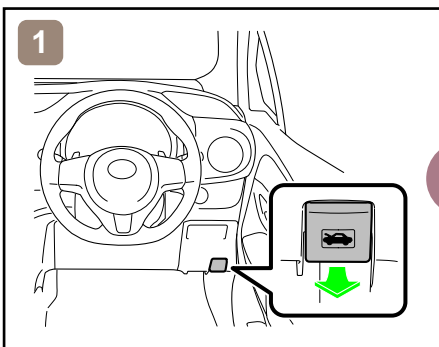

Towing Information

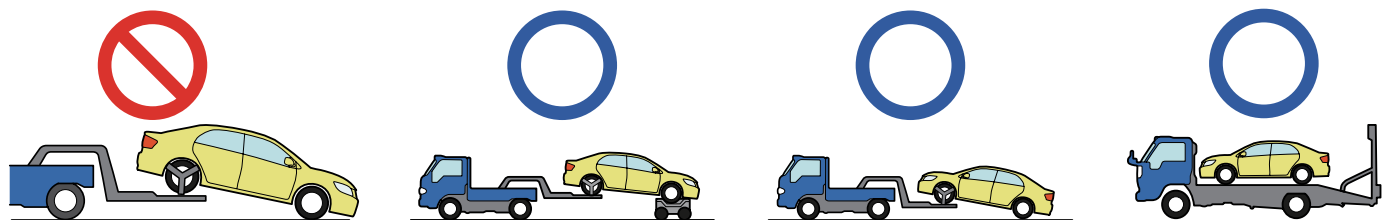

More details, please refer to "Emergency Response Guide".

YARIS

5 DOOR

2014-7

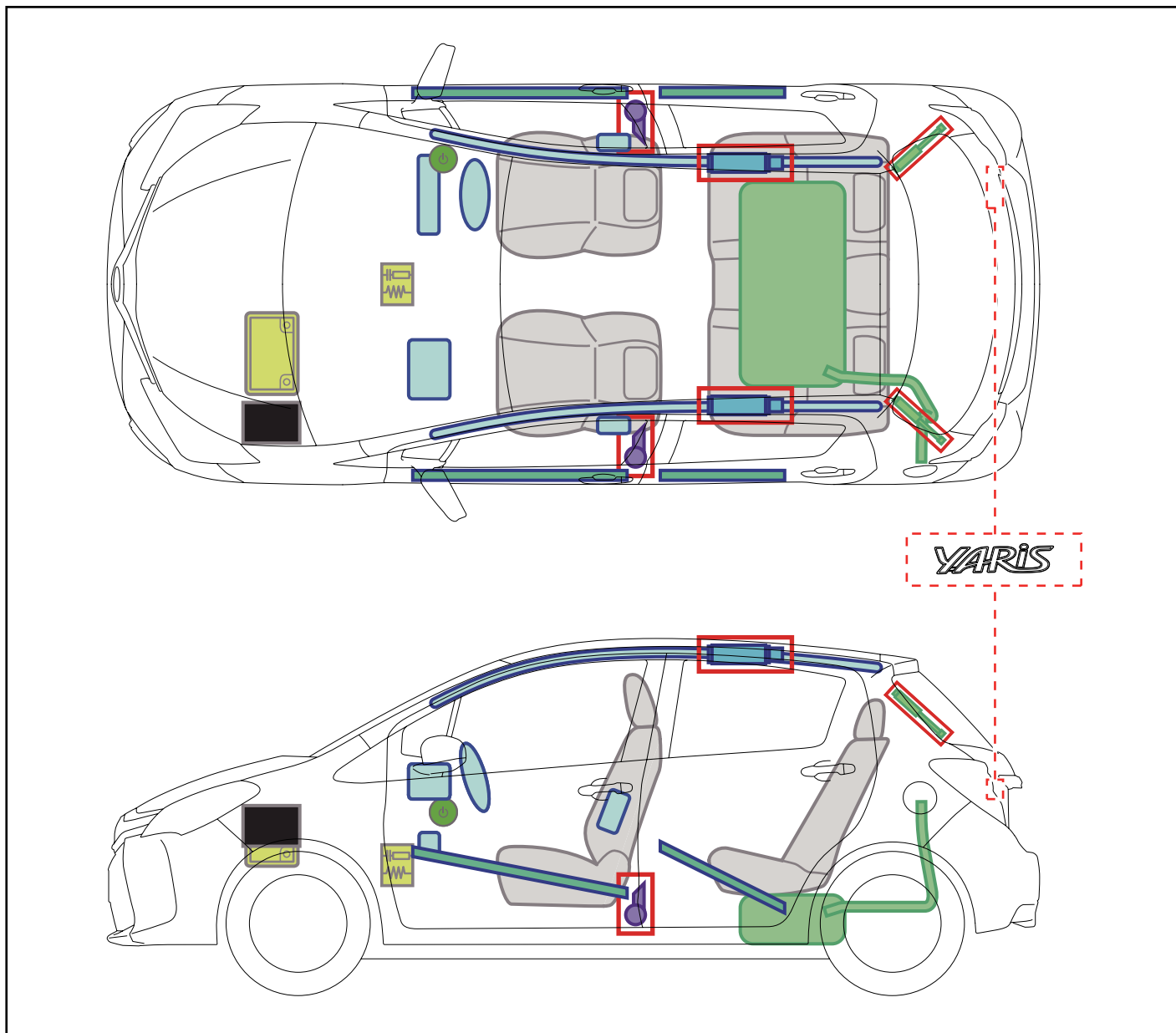
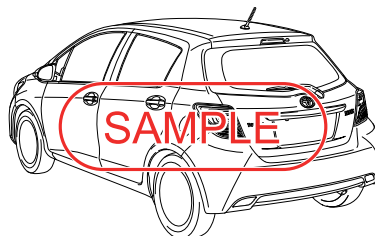
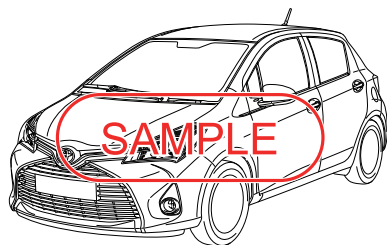

	IG/ENGINE SW		Fuse Box		12V Battery
	Airbag (incl. Inflator)		Inflator		Fuel Tank
	Gas-filled Damper		Seat Belt Pretensioner (Gas Generator)		Structural Reinforcements
	Airbag Computer	—	—	—	—
—	—	—	—	—	—

Disable Vehicle

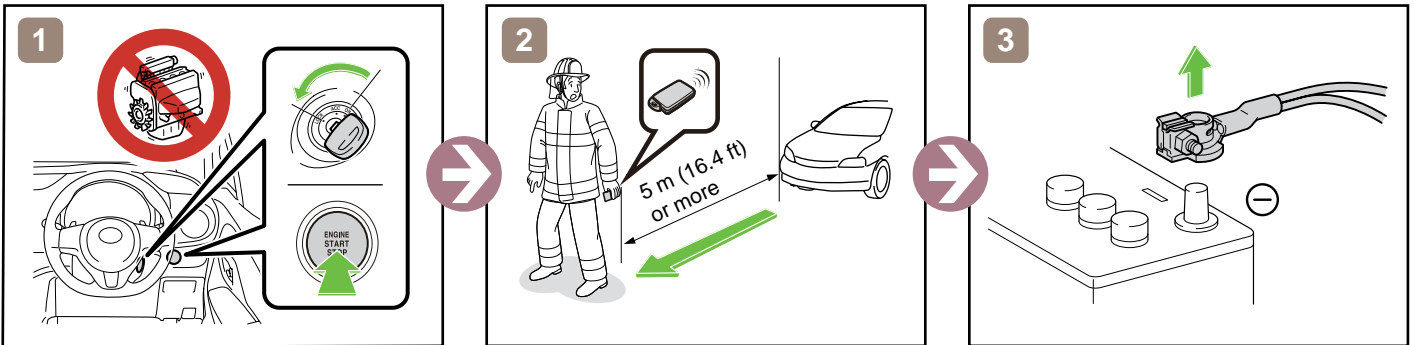

or

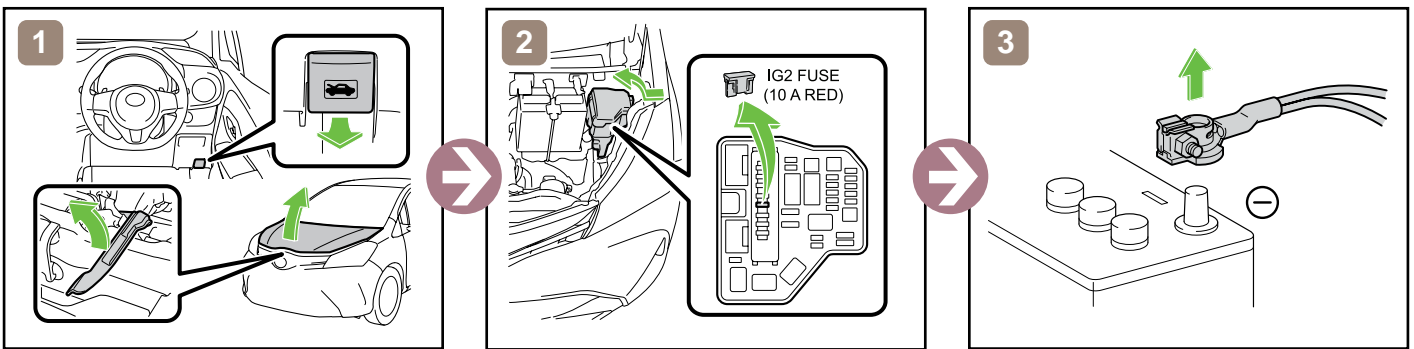

Access to 12V Battery

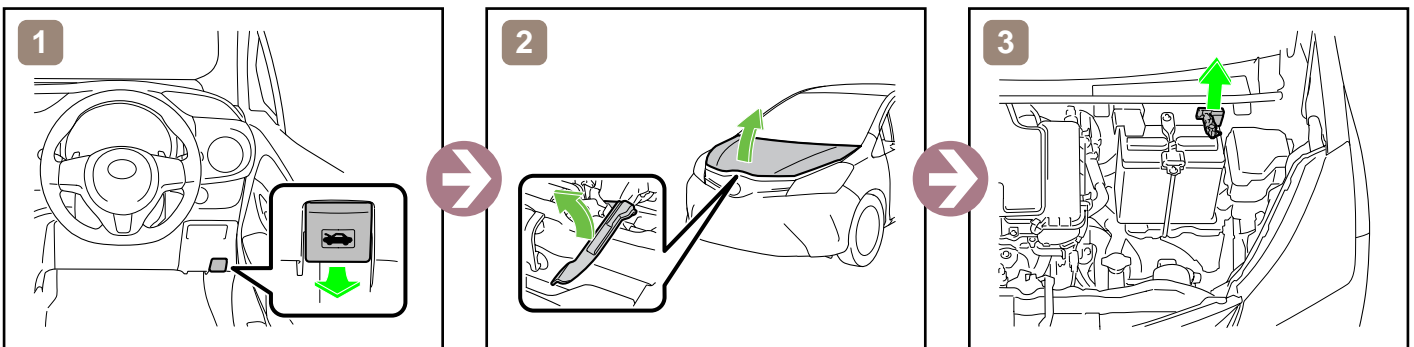

Towing Information

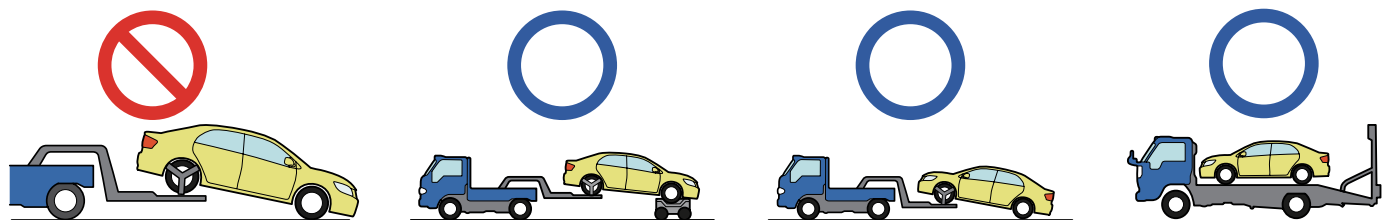

More details, please refer to "Emergency Response Guide".

YARIS

3 DOOR / RHD

2017-3

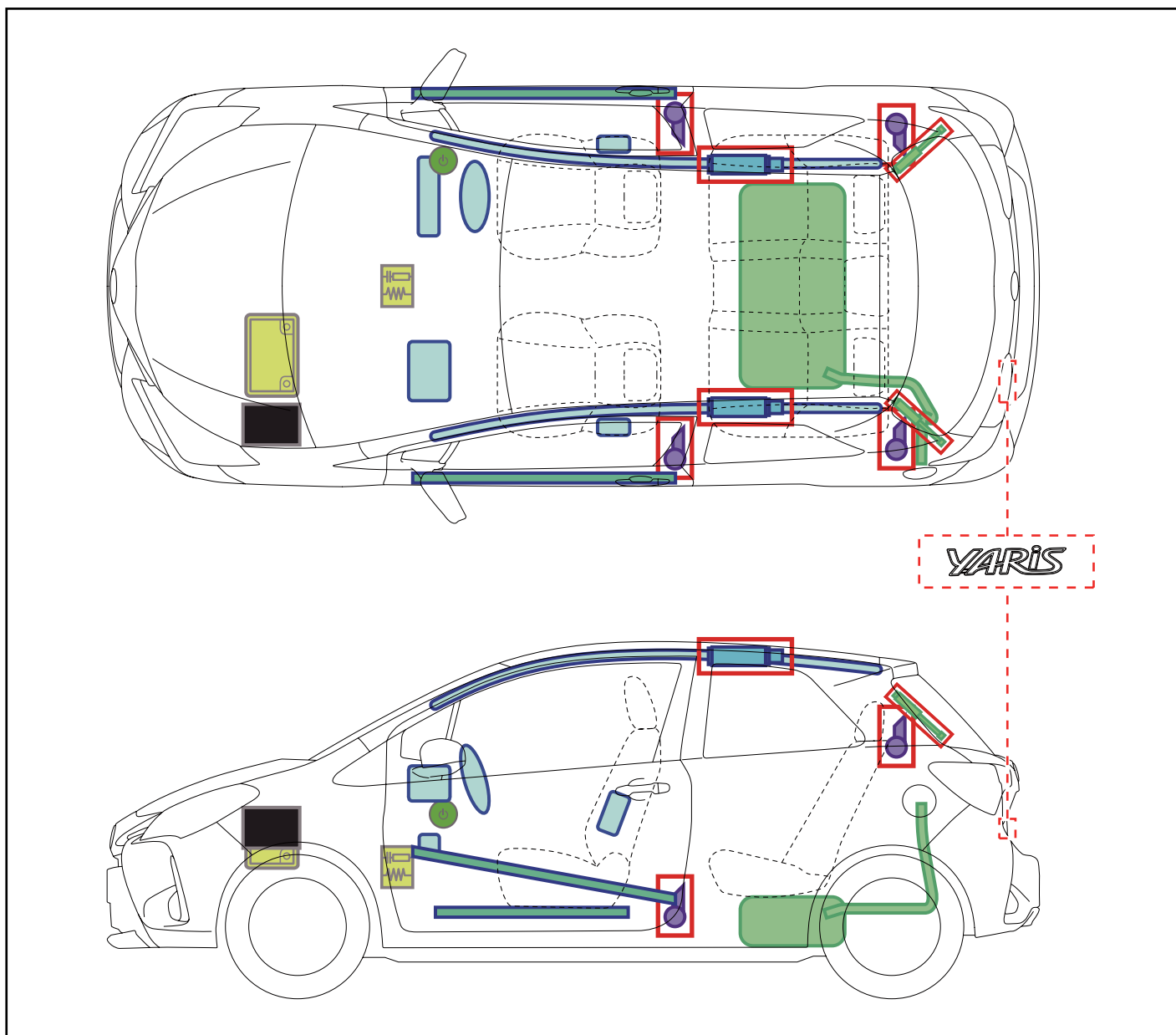
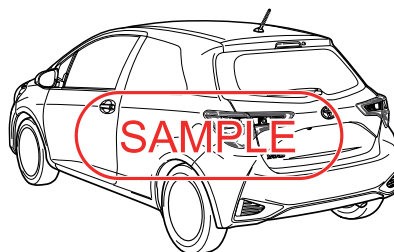
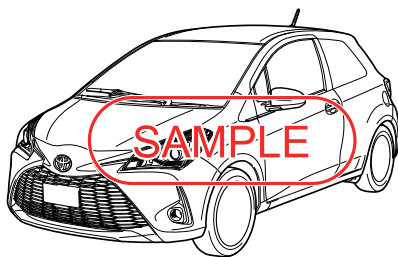

	IG/POWER SW		Fuse Box		12V Battery
	Airbag (incl. Inflator)		Inflator		Fuel Tank
	Gas-filled Damper		Seat Belt Pretensioner (Gas Generator)		Structural Reinforcements
	Airbag Computer	—	—	—	—
—	—	—	—	—	—

Disable Vehicle

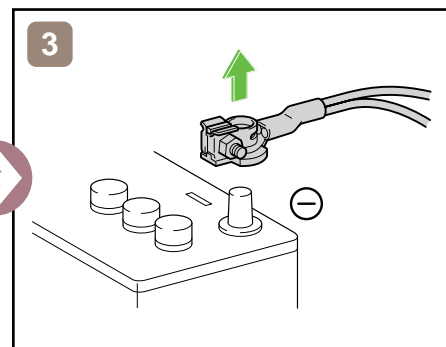
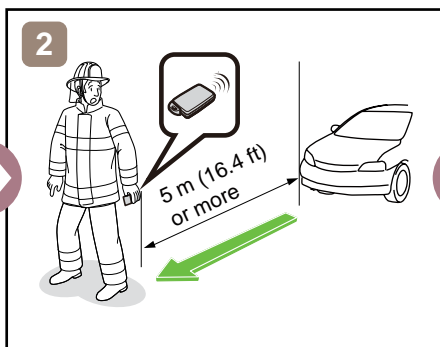
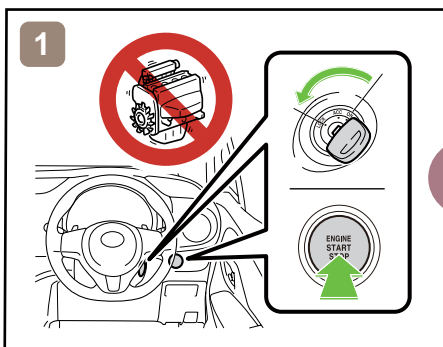

or

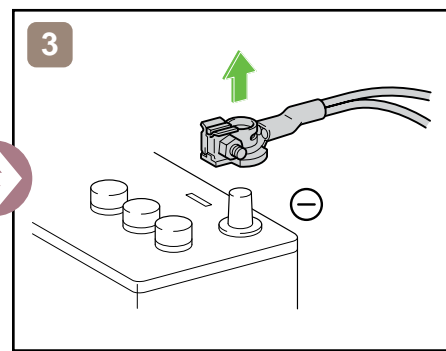
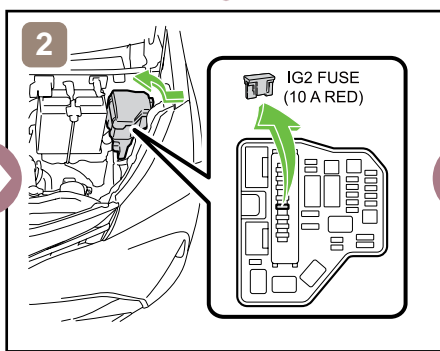
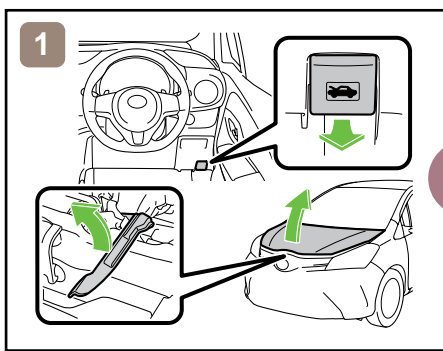

Access to 12V Battery

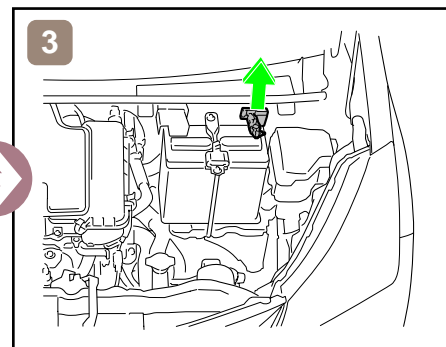
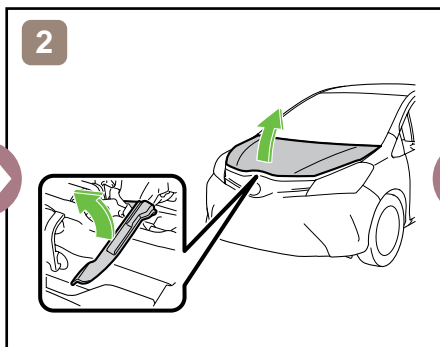
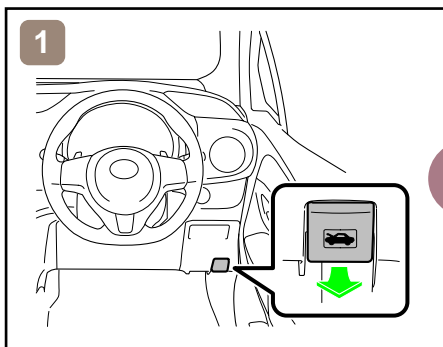

Towing Information

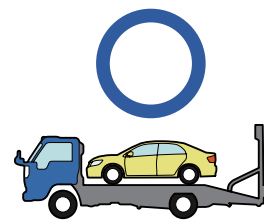
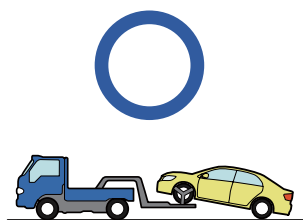
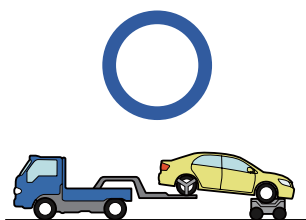
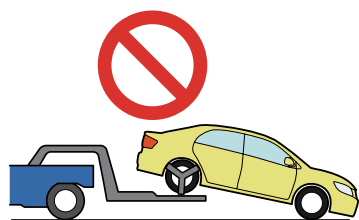

More details, please refer to "Emergency Response Guide".

YARIS

5 DOOR / RHD

2017-3

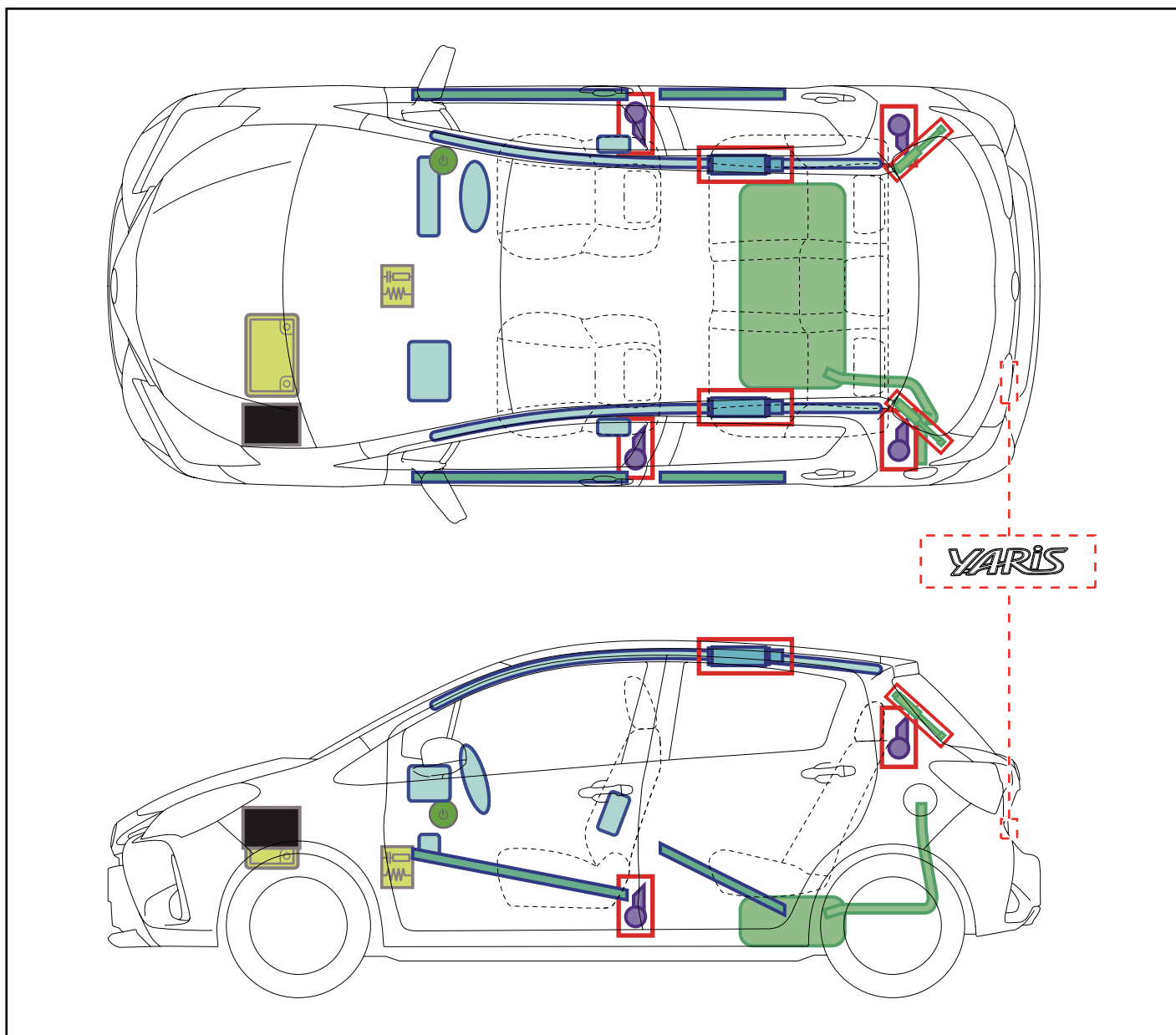
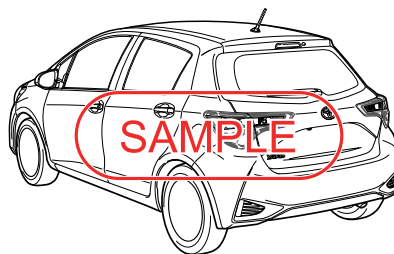
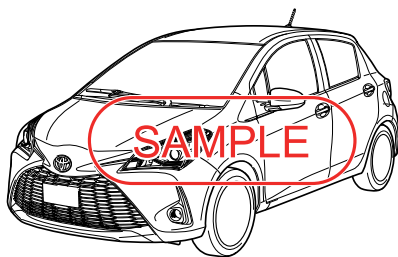

	IG/POWER SW		Fuse Box		12V Battery
	Airbag (incl. Inflator)		Inflator		Fuel Tank
	Gas-filled Damper		Seat Belt Pretensioner (Gas Generator)		Structural Reinforcements
	Airbag Computer	—	—	—	—
—	—	—	—	—	—

Disable Vehicle

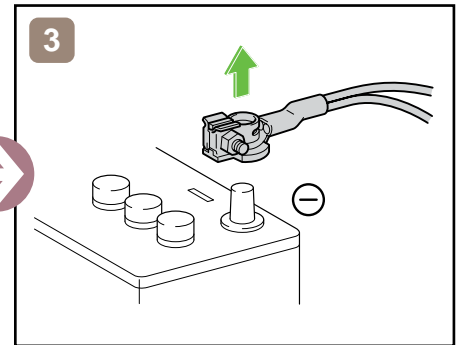
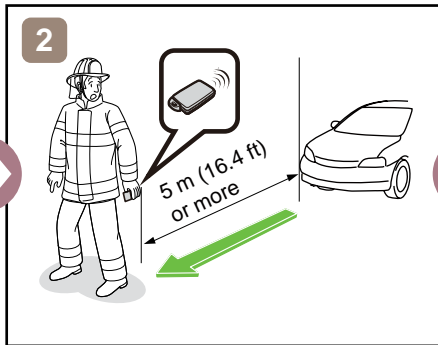
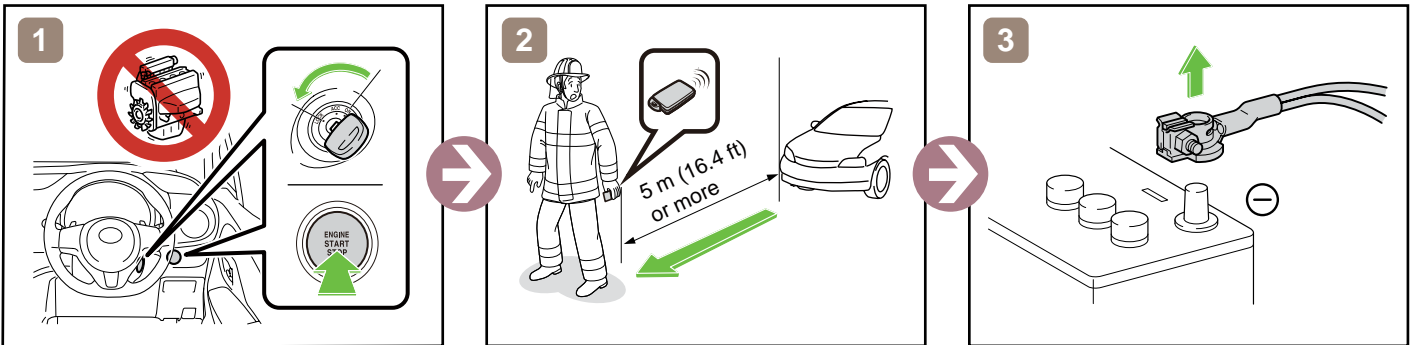

or

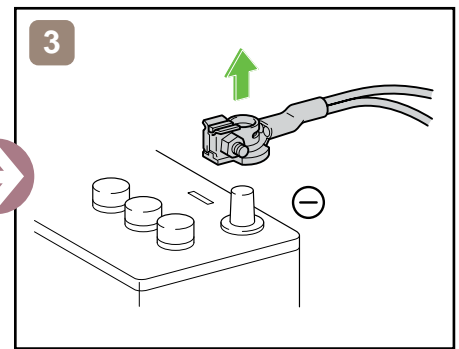
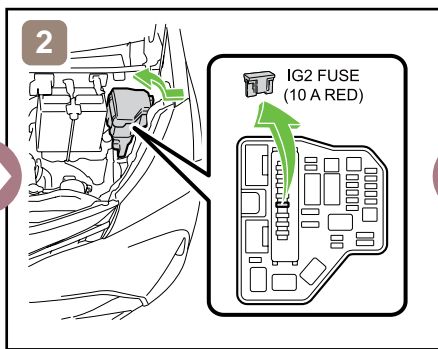
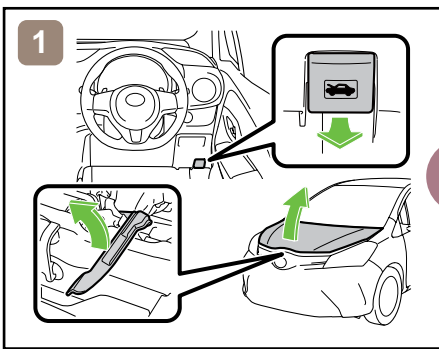

Access to 12V Battery

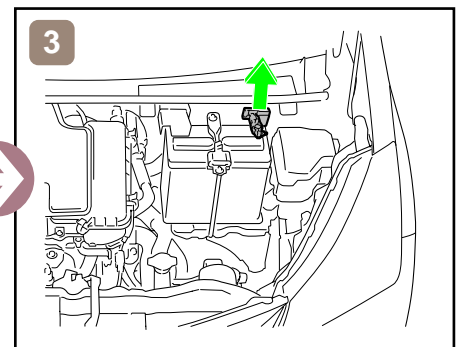
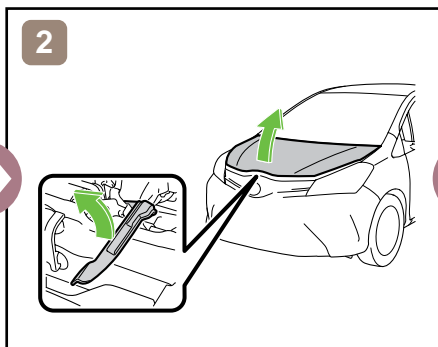
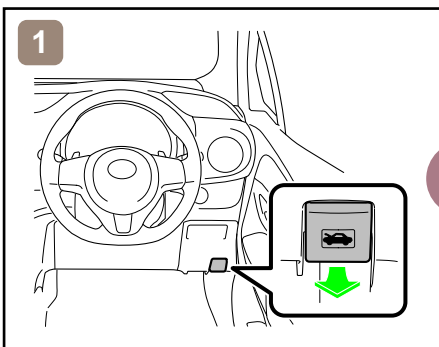

Towing Information

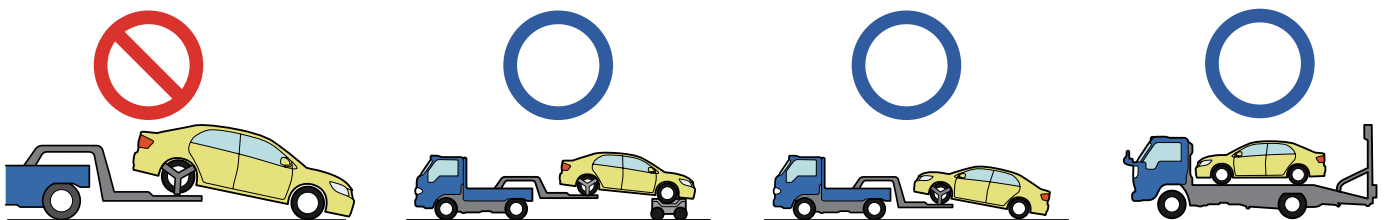

More details, please refer to "Emergency Response Guide".



TOYOTA YARIS

2020-3

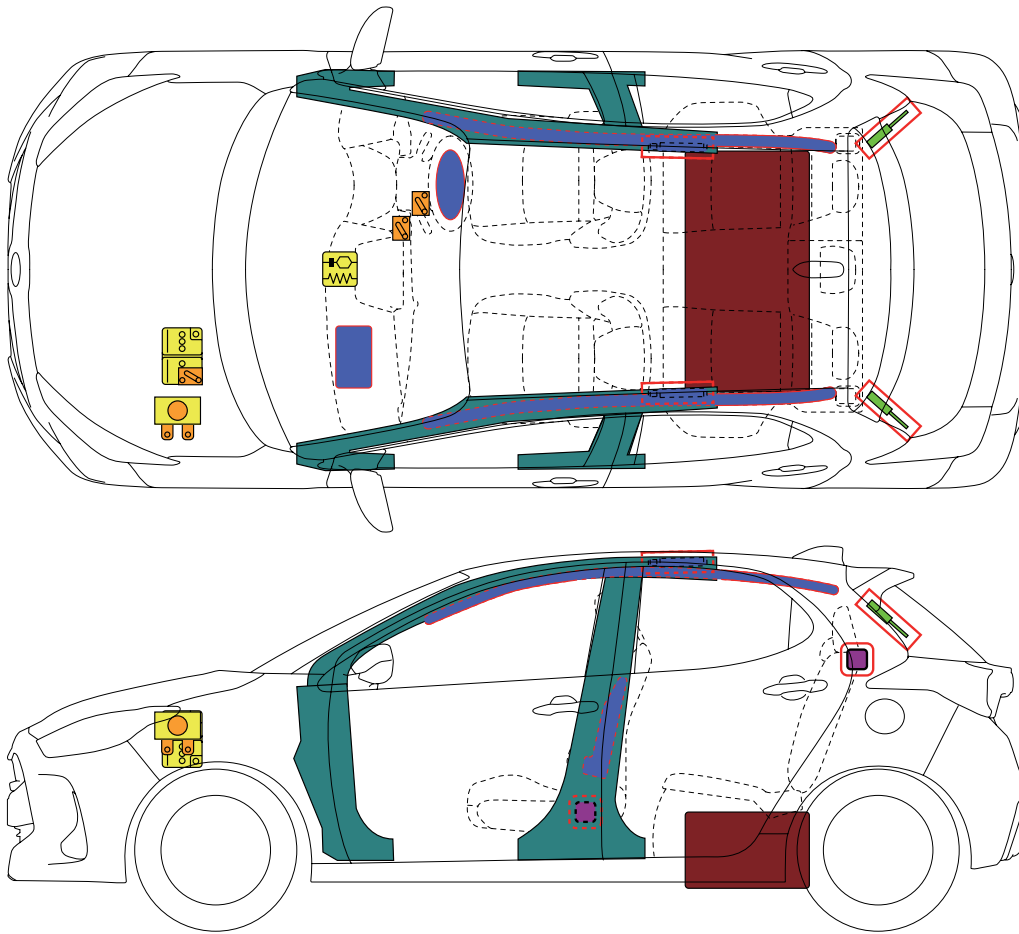

	Airbag		Stored gas inflator		Seat belt pretensioner		SRS control unit		Pedestrian protection active system
	Automatic rollover protection system		Gas strut / Preloaded spring		High strength zone		Zone requiring special attention		
	Battery low voltage		Ultra capacitor, low voltage		Fuel tank		Gas tank		Safety valve
	High voltage battery pack		High voltage power cable / component		High voltage disconnect		Fuse box disabling high voltage system		Ultra capacitor, high voltage
		ID No.	Version No.		Version date		Page		
		YARIS10	01		03 / 2020		1 / 4		

1. Identification / Recognition

■ Location of vehicle badges

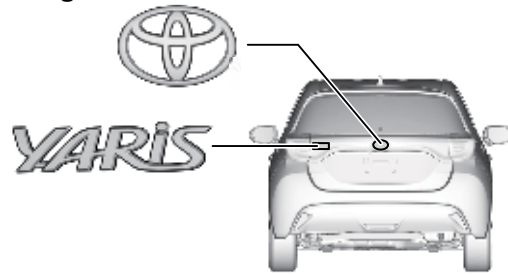

2. Immobilisation / Stabilisation / Lifting

■ Completely immobilise the vehicle

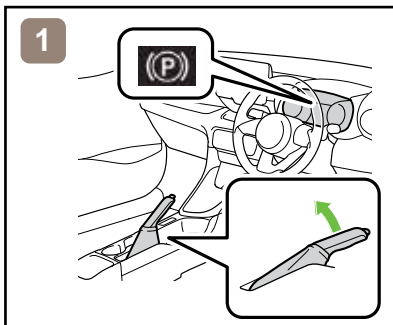

1. Chock the wheels and engage the parking brake.

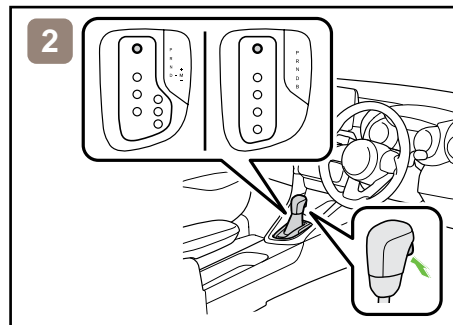

2. Move the shift lever to the park (P) position.*1

*1: CVT

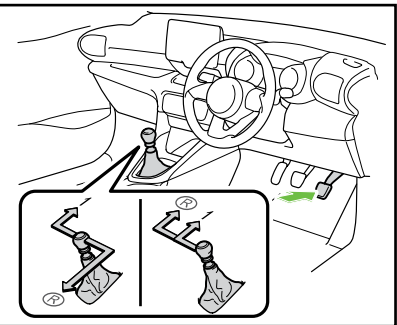



2. Move the shift lever to the 1st or reverse (R) position.*2

*2: M/T

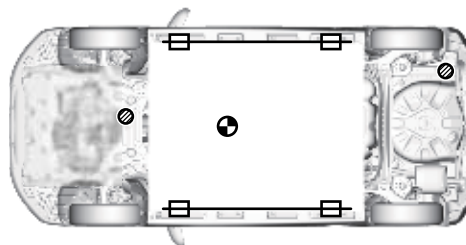
■ To stabilise the vehicle, place cribbing such as wooden blocks at the four points under the front and rear pillars.



 Jack Position

 Support Position

 Vehicle Center of Gravity



Do not place cribbing such as wooden blocks or rescue air lifting bags under the exhaust system, fuel system or high voltage power cables. Doing so may result in fuel leaks, fire, or electric shock.

3. Disable direct hazards / Safety regulations



Even if the engine is stopped, the vehicle may not be shut off. If the vehicle is not completely shut off, the engine may suddenly start or the vehicle may start to move.

■ If any of the following systems are required to be operated, operate them BEFORE disconnecting the battery.

Power door lock

Power window

Back door opener



When the 12 V battery is disconnected, electrical components cannot be operated.

ID No.	Version No.	Version date	Page
YARIS10	01	03 / 2020	2 / 4

■ Perform procedure 1 or 2 to completely shut off the vehicle.

<Procedure 1>

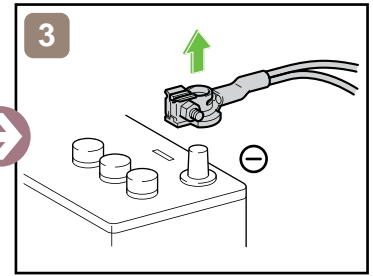
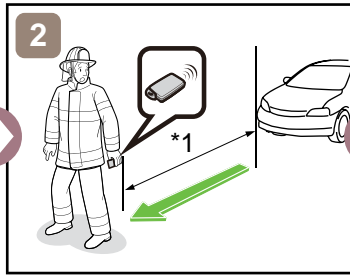
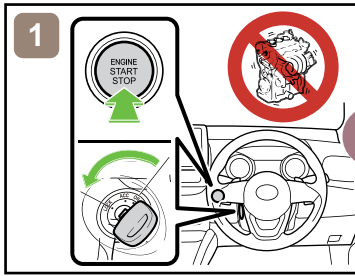
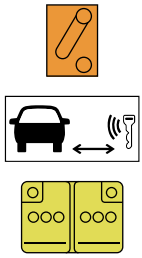

*1: 5 m (16.4 ft) or more

<Procedure 2>

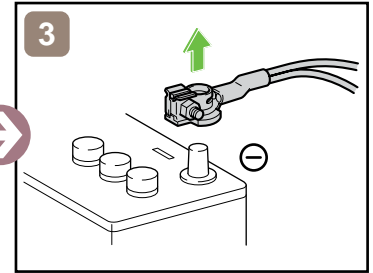
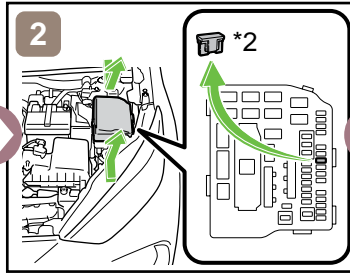
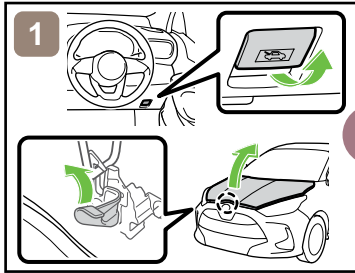
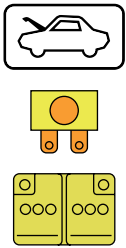

*2: IGP-MAIN FUSE (25 A WHITE)

4. Access the occupants

■ Window Glass

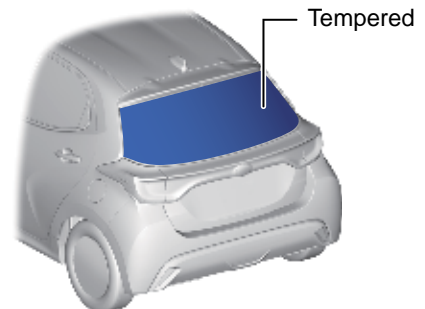
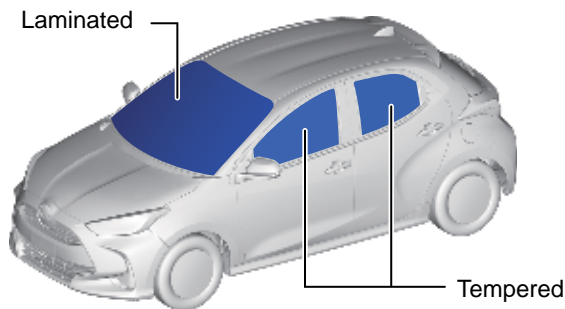

5. Stored energy / Liquids / Gases / Solids



12 V Battery



Petrol Tank: 40 L, 42 L



- Always wear appropriate personal protective equipment (PPE) when dealing with any of these items.

ID No.	Version No.	Version date	Page
YARIS10	01	03 / 2020	3 / 4

6. In case of fire



7. In case of submersion



Work on the vehicle only after the vehicle has been pulled out of the water.

8. Towing / Transportation / Storage

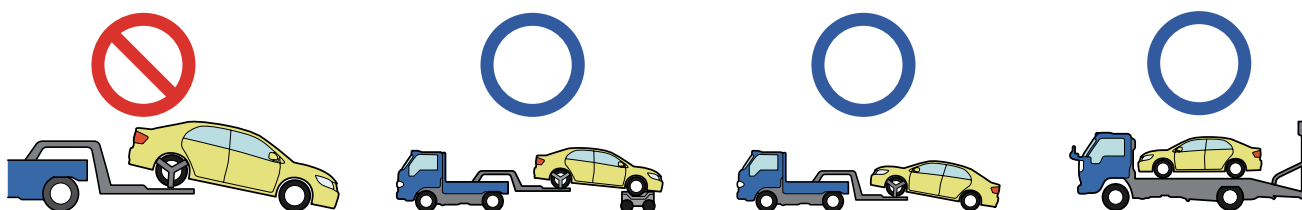

Store the vehicle at a safe distance (15 m (49.2 ft) or more) from other vehicles.

9. Important additional information

For further details, please refer to "Emergency Response Guide".

ID No.	Version No.	Version date	Page
YARIS10	01	03 / 2020	4 / 4



TOYOTA YARIS CROSS

2020-8

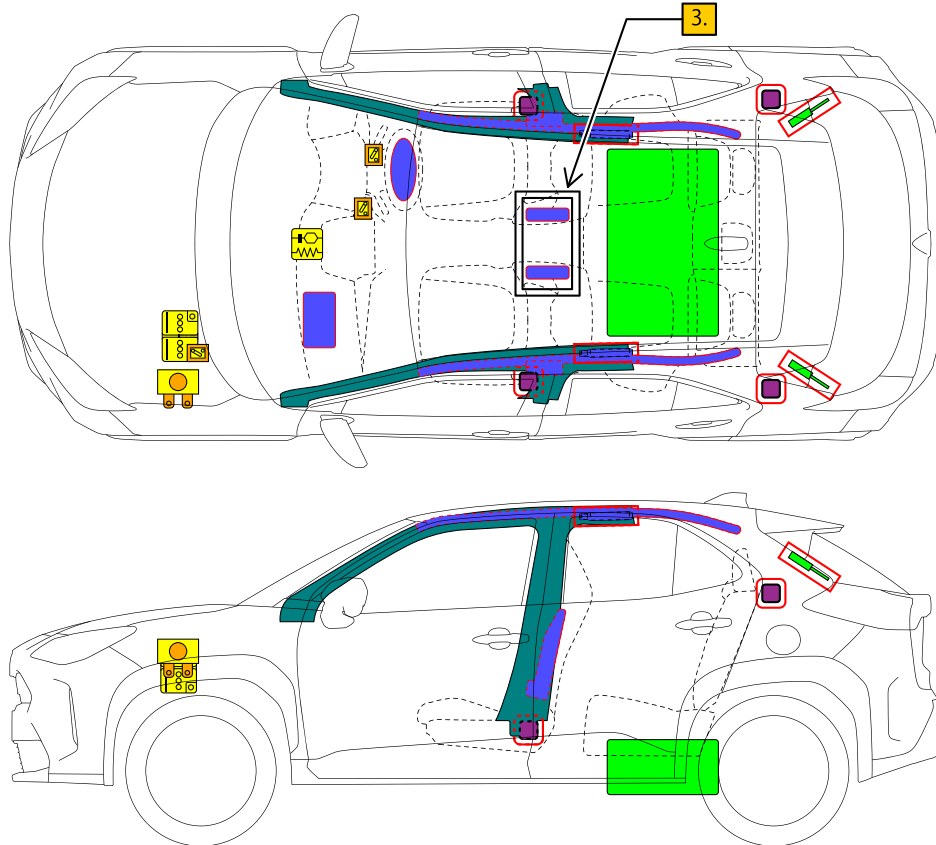
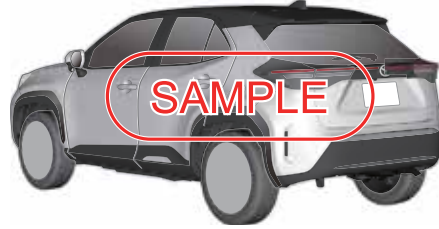
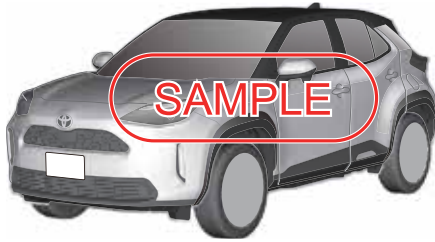

	Airbag		Stored gas inflator		Seat belt pretensioner		SRS control unit		Pedestrian protection active system
	Automatic rollover protection system		Gas strut / Preloaded spring		High strength zone		Zone requiring special attention		
	Battery low voltage		Ultra capacitor, low voltage		Fuel tank		Gas tank		Safety valve
	High voltage battery pack		High voltage power cable / component		High voltage disconnect		Fuse box disabling high voltage system		Ultra capacitor, high voltage
	Low voltage device that disconnects high voltage								
	ID No.	Version No.		Version date		Page			
	YARISCROSS10	02		08 / 2020		1 / 4			

1. Identification / Recognition

Location of vehicle badges

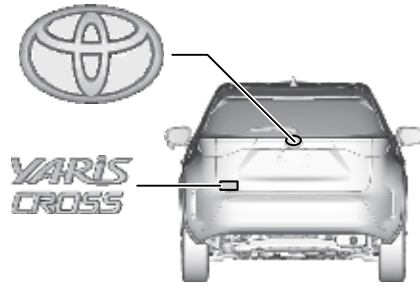

2. Immobilisation / Stabilisation / Lifting

Completely immobilize the vehicle

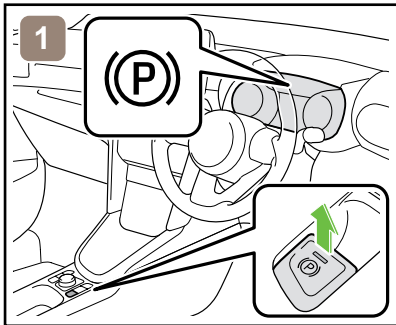

1. Chock the wheels and engage the parking brake.

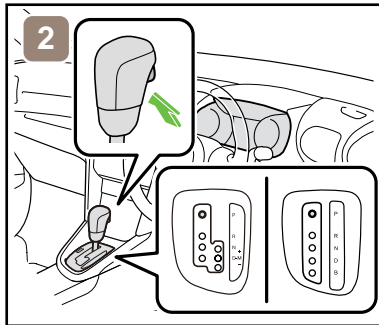

2. Move the shift lever to the park (P) position.*1

*1: CVT

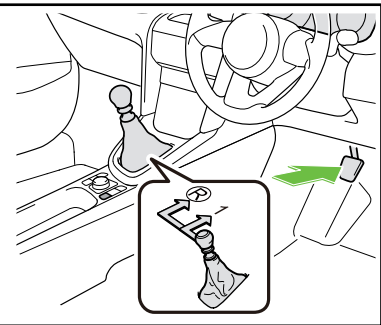

2. Depress the clutch pedal and move the shift lever to the 1st or reverse (R) position.*2

*2: M/T

Stabilisation-lifting point

Place cribbing such as wooden blocks at the four points under the front and rear pillars.

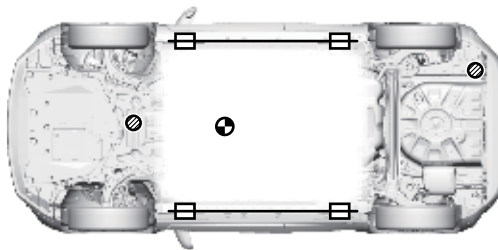

Extra Reinforced Lifting Points



Standard Jack Locations



Vehicle Center of Gravity



Do not place cribbing such as wooden blocks or rescue air lifting bags under the exhaust system or fuel system. Doing so may result in fuel leaks or fire.

3. Disable direct hazards / Safety regulations

If any of the following systems are required to be operated, operate them BEFORE disconnecting the battery.

Power door lock

Power window

Power seat

Electric parking brake

Power back door opener



When the 12 V battery is disconnected, electrical components cannot be operated.

ID No.	Version No.	Version date	Page
YARISCROSS10	02	08 / 2020	2 / 4

■ Perform procedure Main or Alternative to completely shut off the vehicle.

<Procedure Main>

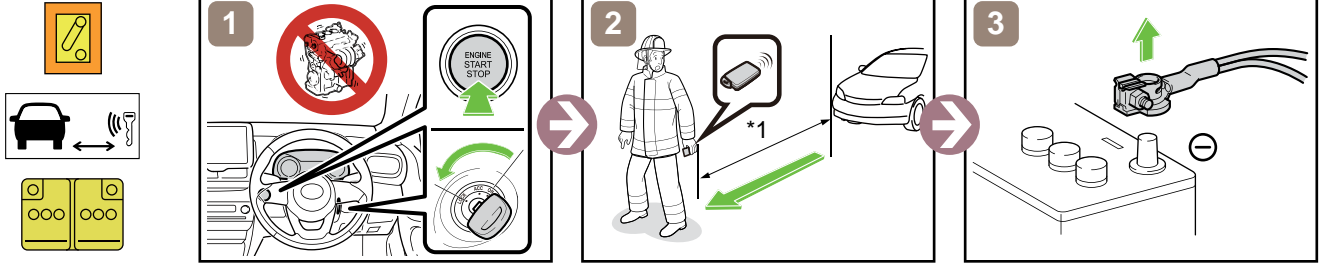

*1: 5 m (16.4 ft) or more

<Procedure Alternative>

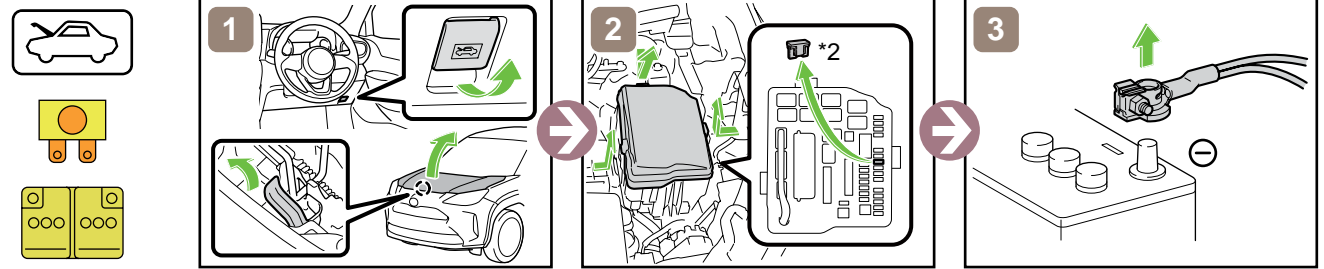

*2: IGP-MAIN FUSE (25 A CLEAR)

■ Access to 12 V Battery

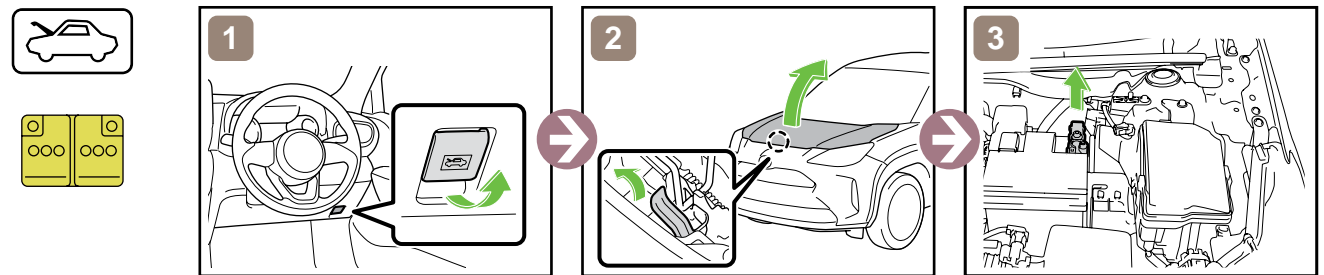

4. Access to the occupants

■ Window Glass

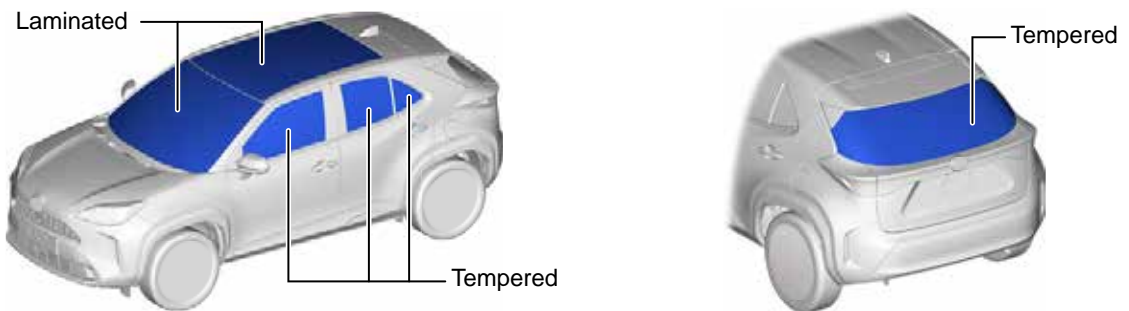

	ID No.	Version No.	Version date	Page
	YARISCROSS10	02	08 / 2020	3 / 4

5. Stored energy / Liquids / Gases / Solids



12 V Battery



Gasoline Tank: 42 L



Always wear appropriate personal protective equipment (PPE) when dealing with any of these items.

6. In case of fire

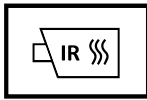

RE-IGNITION POSSIBLE !

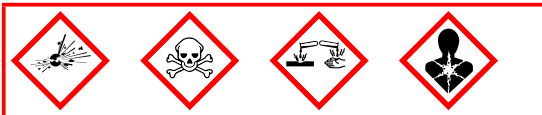

7. In case of submersion



Work on the vehicle only after the vehicle has been pulled out of the water.

8. Towing / Transportation / Storage

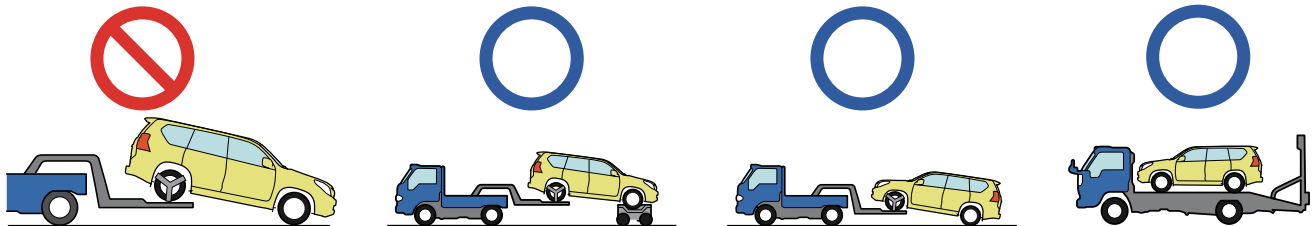

RE-IGNITION POSSIBLE !

Store the vehicle at a safe distance (15 m (49.2 ft) or more) from other vehicles.

9. Important additional information

For further details, please refer to "Emergency Response Guide".

	ID No.	Version No.	Version date	Page
	YARISCROSS10	02	08 / 2020	4 / 4



TOYOTA YARIS CROSS HYBRID

2020-8

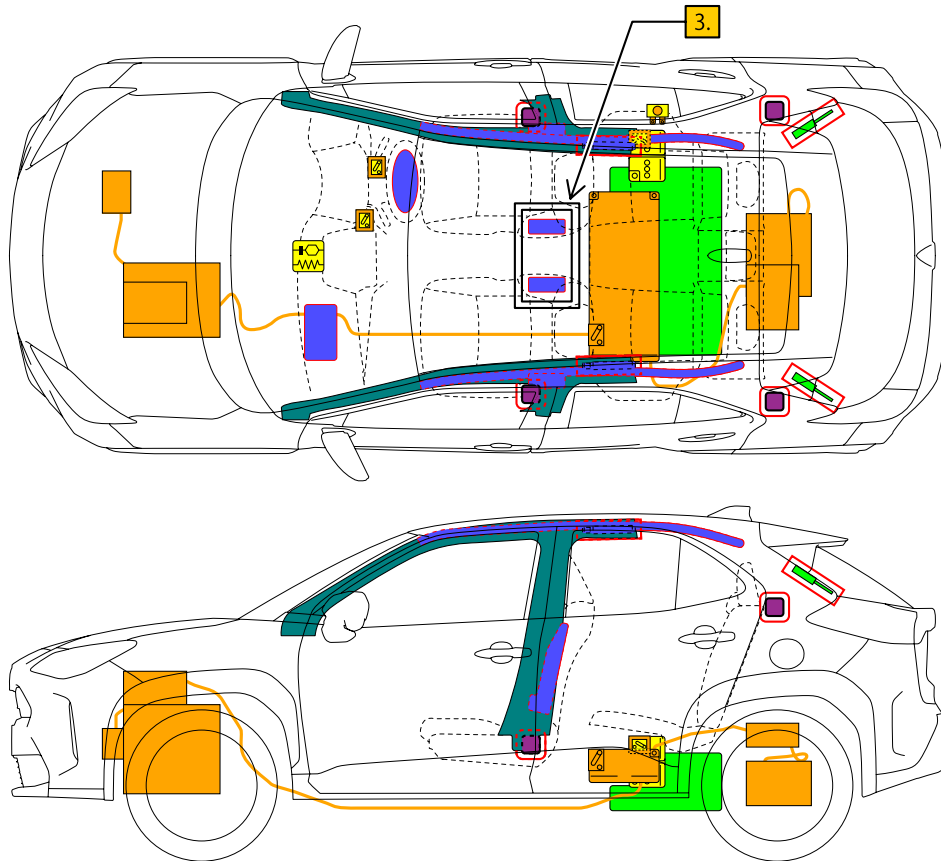
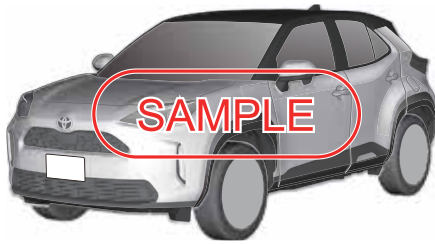

	Airbag		Stored gas inflator		Seat belt pretensioner		SRS control unit		Pedestrian protection active system
	Automatic rollover protection system		Gas strut / Preloaded spring		High strength zone		Zone requiring special attention		
	Battery low voltage		Ultra capacitor, low voltage		Fuel tank		Gas tank		Safety valve
	High voltage battery pack		High voltage power cable / component		High voltage disconnect		Fuse box disabling high voltage system		Ultra capacitor, high voltage
	Low voltage device that disconnects high voltage		High voltage component						
	ID No.	Version No.		Version date		Page			
	YARISCROSSHV10	02		08 / 2020		1 / 4			

1. Identification / Recognition



Lack of engine noise does not mean vehicle is off. Silent movement or instant restart capability exists until vehicle is fully shut down.

■ Location of vehicle badges



■ Energy source: Lithium-ion battery



2. Immobilisation / Stabilisation / Lifting

■ Completely immobilize the vehicle

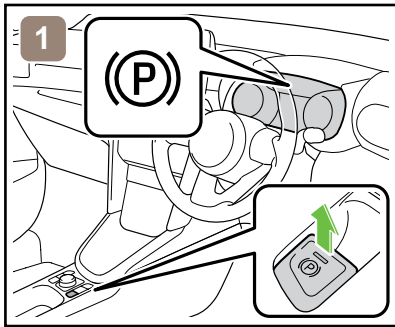

1. Chock the wheels and engage the parking brake.

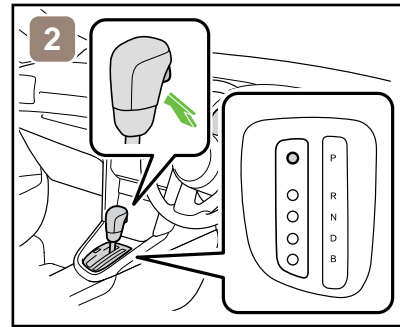

2. Move the shift lever to the park (P) position.

■ Stabilisation-lifting point

Place cribbing such as wooden blocks at the four points under the front and rear pillars.

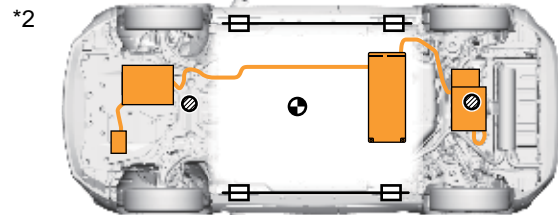
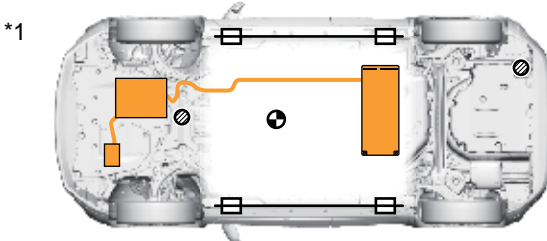

Extra Reinforced Lifting Points
 Standard Jack Locations
 Vehicle Center of Gravity

*1: 2WD

*2: AWD



Do not place cribbing such as wooden blocks or rescue air lifting bags under the exhaust system, fuel system or high voltage power cables. Doing so may result in fuel leaks, fire, or electric shock.

3. Disable direct hazards / Safety regulations

■ If any of the following systems are required to be operated, operate them BEFORE disconnecting the battery.

Power door lock Power window Power seat
 Electric parking brake Power back door opener



When the 12 V battery is disconnected, electrical components cannot be operated.

	ID No.	Version No.	Version date	Page
	YARISCROSSHV10	02	08 / 2020	2 / 4

■ Perform procedure Main or Alternative to completely shut off the vehicle.

<Procedure Main>

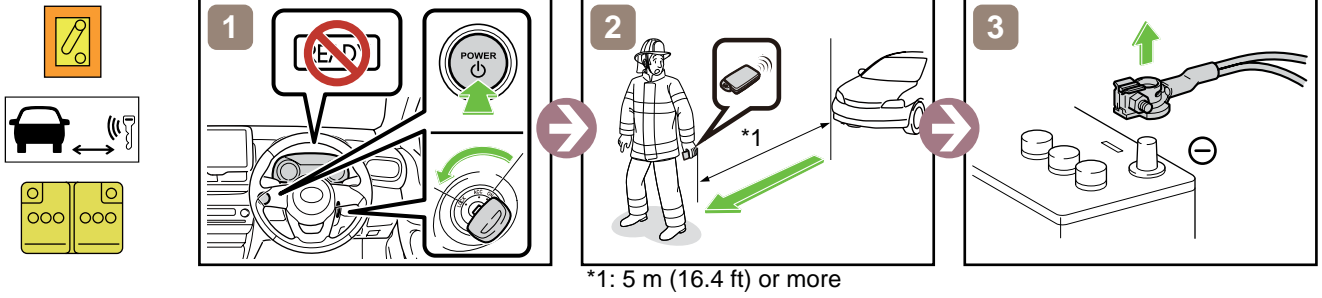

<Procedure Alternative>

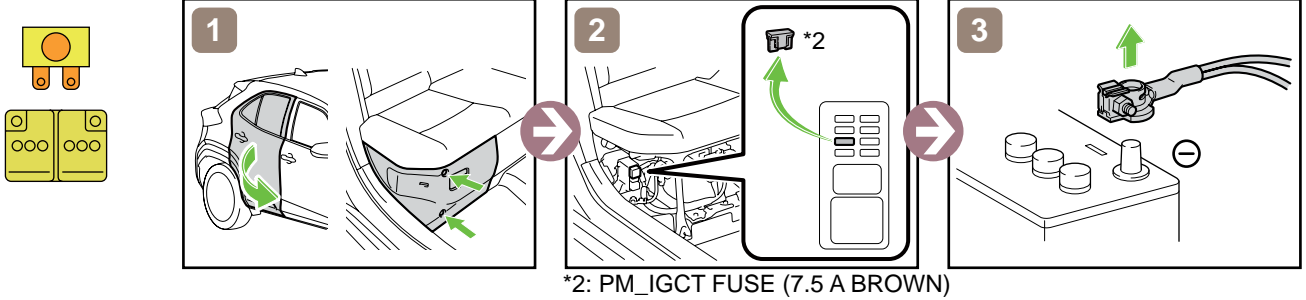

■ Access to 12 V Battery

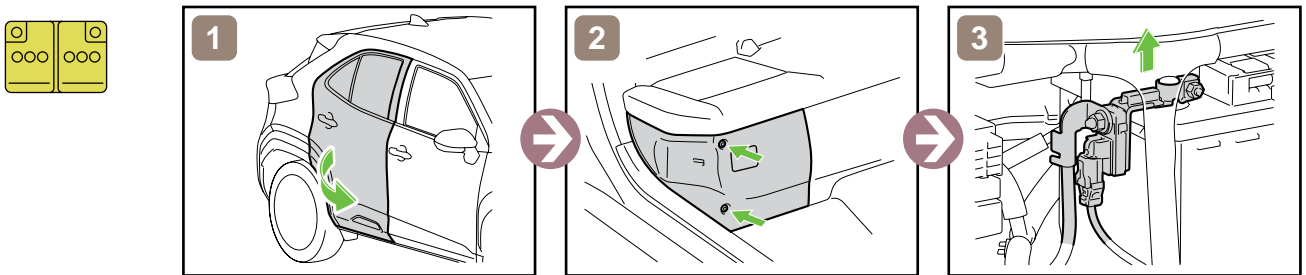

4. Access to the occupants

■ Window Glass

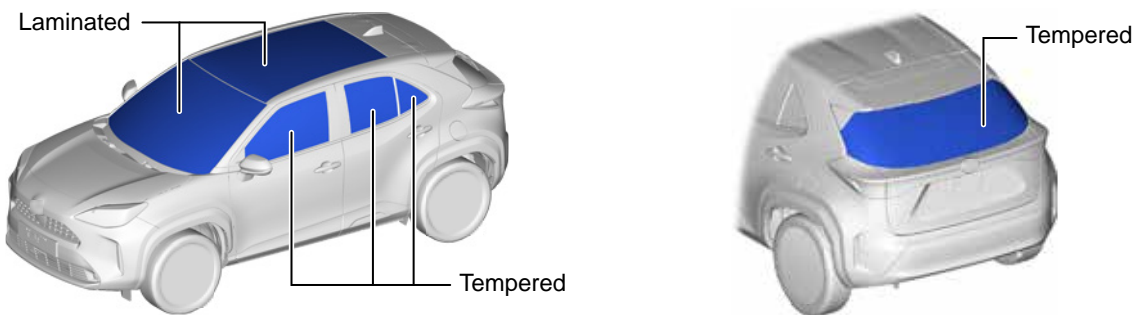

5. Stored energy / Liquids / Gases / Solids



High Voltage Li-ion Battery



12 V Battery



Gasoline Tank: 36 L

ID No.	Version No.	Version date	Page
YARISCROSSHV10	02	08 / 2020	3 / 4



- Always wear appropriate personal protective equipment (PPE) when dealing with any of these items.
- Never breach or remove the battery assembly cover under any circumstances, including fire. Doing so may result in serious injury or death from severe burns or electric shock.

6. In case of fire



USE COPIOUS AMOUNTS OF WATER

If it is difficult to apply copious amounts of water to the high voltage battery, it is recommended to allow the high voltage battery to burn itself out.

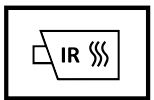

RE-IGNITION POSSIBLE !



7. In case of submersion



Do not touch any of the high-voltage components or cables, including the service plug, while the vehicle is submerged. Doing so may result in electric shock.
Work on the vehicle only after the vehicle has been pulled out of the water.

8. Towing / Transportation / Storage

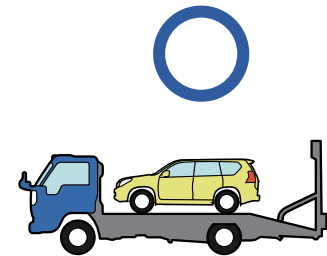
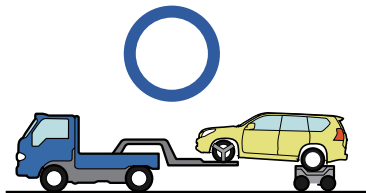

RE-IGNITION POSSIBLE !

Store the vehicle at a safe distance (15 m (49.2 ft) or more) from other vehicles.

9. Important additional information

For further details, please refer to "Emergency Response Guide".

	ID No.	Version No.	Version date	Page
	YARISCROSSHV10	02	08 / 2020	4 / 4



TOYOTA YARIS CROSS HYBRID
5 doors / 5 seats / hatchback
2024-01

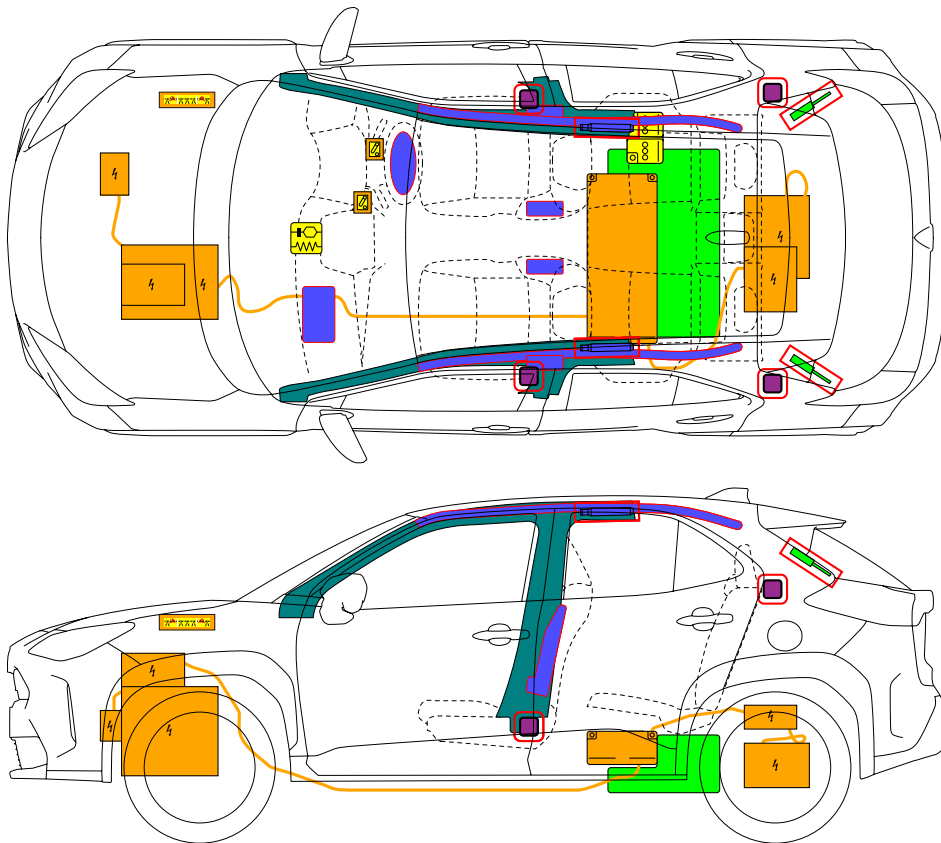
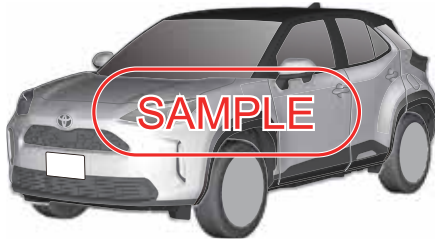

	Airbag		Stored gas inflator		Seat belt pretensioner		SRS control unit		
	Gas strut / Preloaded spring		High strength zone						
	Battery low voltage		Fuel tank						
	High voltage battery pack		High voltage power cable / component		Low voltage device that disconnects high voltage		Cable Cut		High voltage component
	ID No.	Version No.	Version date	Page					
	YARISCROSSHV10	03	01 / 2024	1 / 4					

1. Identification / Recognition



Lack of engine noise does not mean vehicle is off. Silent movement or instant restart capability exists until vehicle is fully shut down.

Location of vehicle badges



Energy source: Lithium-ion battery



2. Immobilisation / Stabilisation / Lifting

Completely immobilize the vehicle

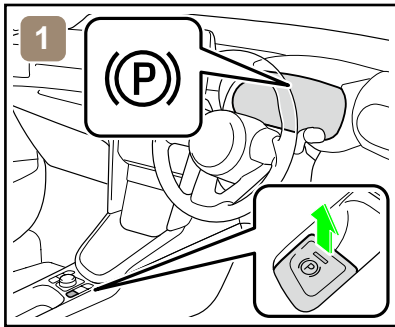

1. Chock the wheels and engage the parking brake.

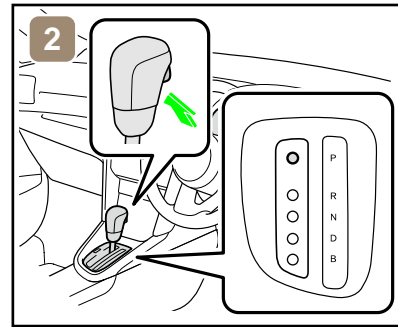

2. Move the shift lever to the park (P) position.

Stabilisation-lifting point

Place cribbing such as wooden blocks at the four points under the front and rear pillars.

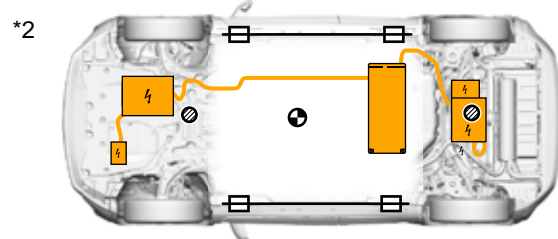
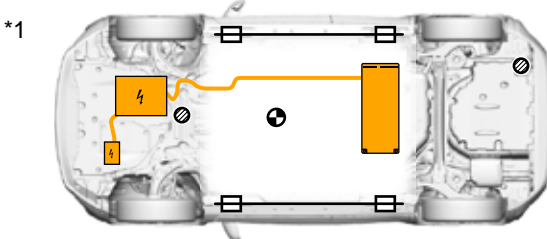

Extra Reinforced Lifting Points
 Standard Jack Locations
 Vehicle Center of Gravity

*1: 2WD

*2: AWD



Do not place cribbing such as wooden blocks or rescue air lifting bags under the exhaust system, fuel system or high voltage power cables. Doing so may result in fuel leaks, fire, or electric shock.

3. Disable direct hazards / Safety regulations

If any of the following systems are required to be operated, operate them BEFORE disconnecting the battery.

- Power door lock
- Power window
- Power seat
- Electric parking brake
- Power back door opener

When the 12 V battery is disconnected, electrical components cannot be operated.

	ID No.	Version No.	Version date	Page
	YARISCROSSHV10	03	01 / 2024	2 / 4

■ Perform procedure Main or Alternative to completely shut off the vehicle.

<Main Procedure>

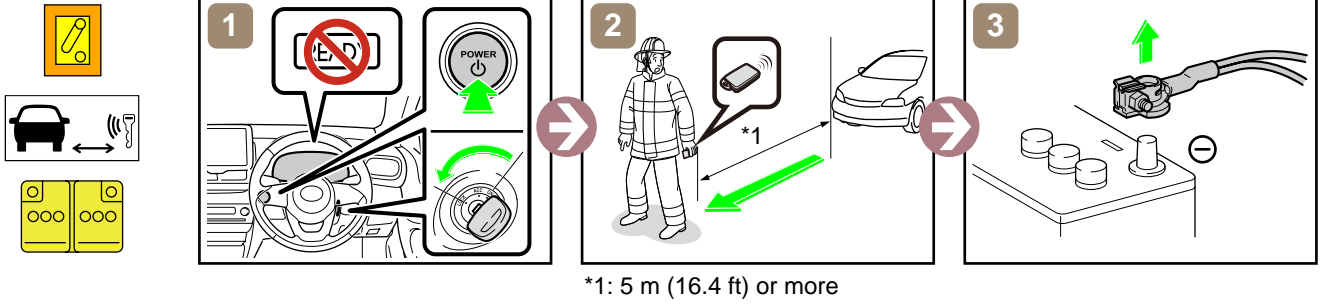

<Alternative Procedure>

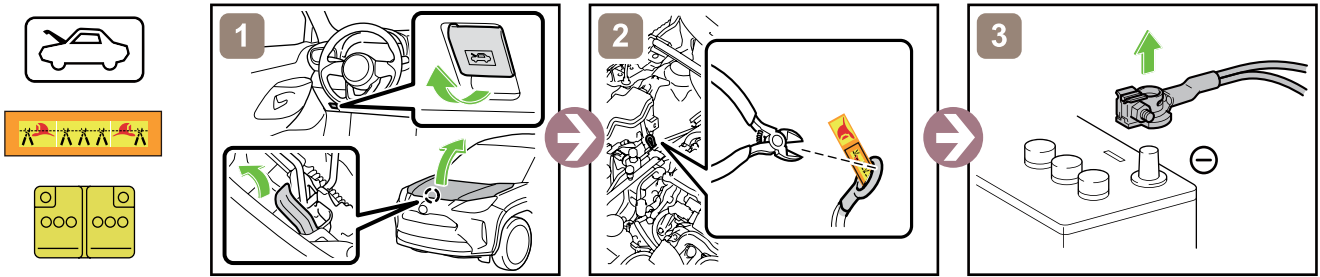

In the event of an accident in which the airbags deployed, the high-voltage system will be automatically deactivated.

■ Access to 12 V Battery

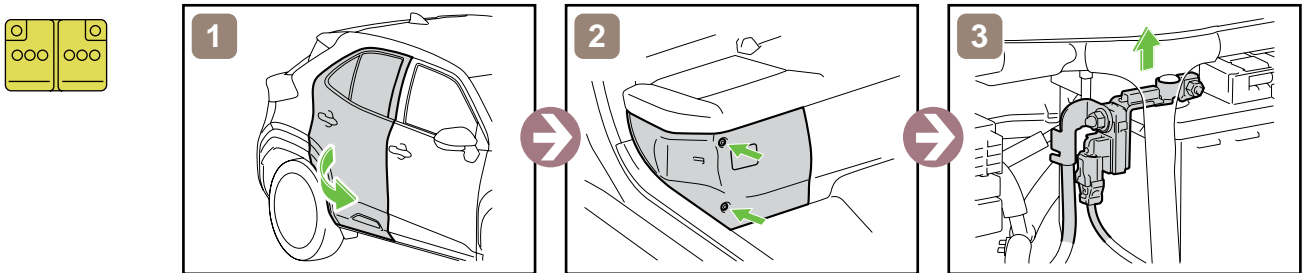

4. Access to the occupants

■ Window Glass

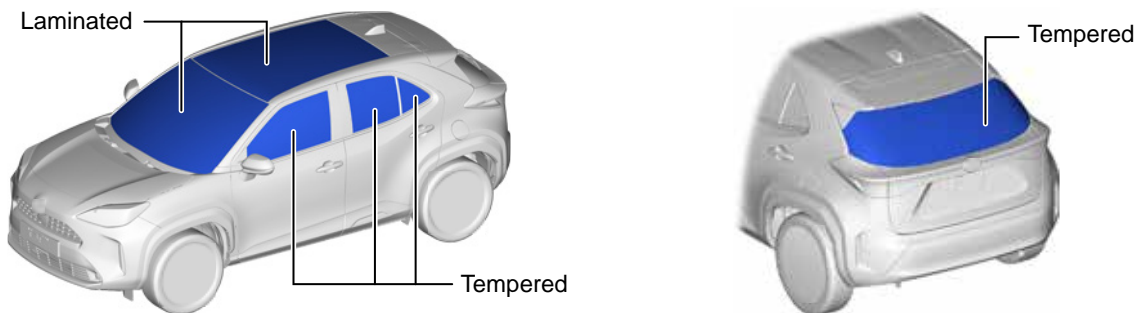

5. Stored energy / Liquids / Gases / Solids



High Voltage Li-ion Battery



12 V Battery



Gasoline Tank: 36 L

ID No.	Version No.	Version date	Page
YARISCROSSHV10	03	01 / 2024	3 / 4



- Always wear appropriate personal protective equipment (PPE) when dealing with any of these items.
- Never breach or remove the battery assembly cover under any circumstances, including fire. Doing so may result in serious injury or death from severe burns or electric shock.

6. In case of fire



USE COPIOUS AMOUNTS OF WATER

If it is difficult to apply copious amounts of water to the high voltage battery, it is recommended to allow the high voltage battery to burn itself out.

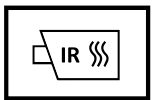

RE-IGNITION POSSIBLE !



7. In case of submersion



Do not touch any of the high-voltage components or cables, including the service plug, while the vehicle is submerged. Doing so may result in electric shock.
Work on the vehicle only after the vehicle has been pulled out of the water.

8. Towing / Transportation / Storage

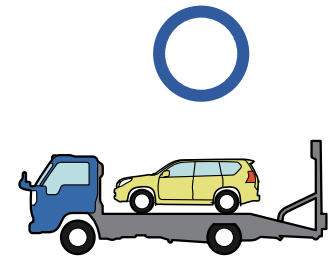
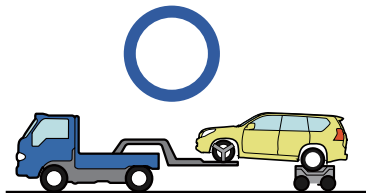

RE-IGNITION POSSIBLE !

Store the vehicle at a safe distance (15 m (49.2 ft) or more) from other vehicles.

9. Important additional information

For further details, please refer to "Emergency Response Guide".

	ID No.	Version No.	Version date	Page
	YARISCROSSHV10	03	01 / 2024	4 / 4



TOYOTA YARIS HYBRID

2020-3

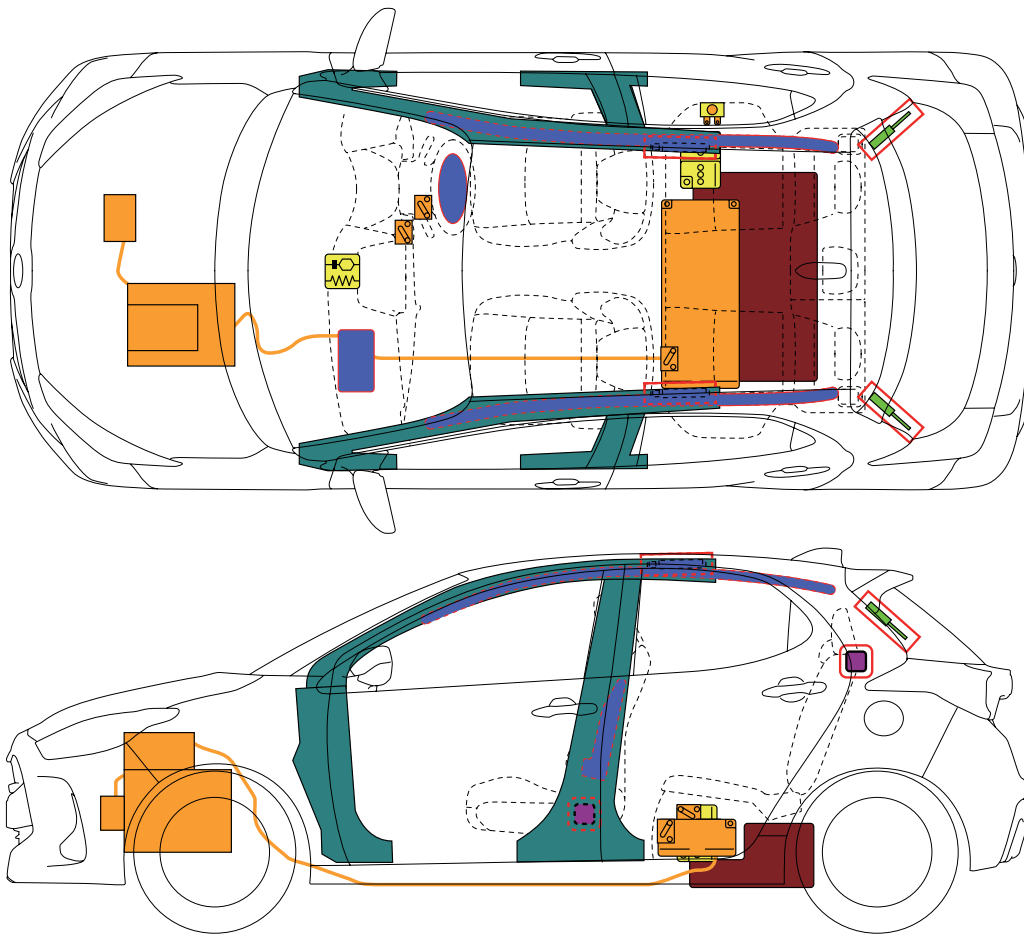

	Airbag		Stored gas inflator		Seat belt pretensioner		SRS control unit		Pedestrian protection active system
	Automatic rollover protection system		Gas strut / Preloaded spring		High strength zone		Zone requiring special attention		Safety valve
	Battery low voltage		Ultra capacitor, low voltage		Fuel tank		Gas tank		High voltage component
	High voltage battery pack		High voltage power cable / component		High voltage disconnect		Fuse box disabling high voltage system		Ultra capacitor, high voltage
		ID No.	Version No.	Version date		Page			
		YARISHV10	01	03 / 2020		1 / 4			

1. Identification / Recognition

■ Location of vehicle badges

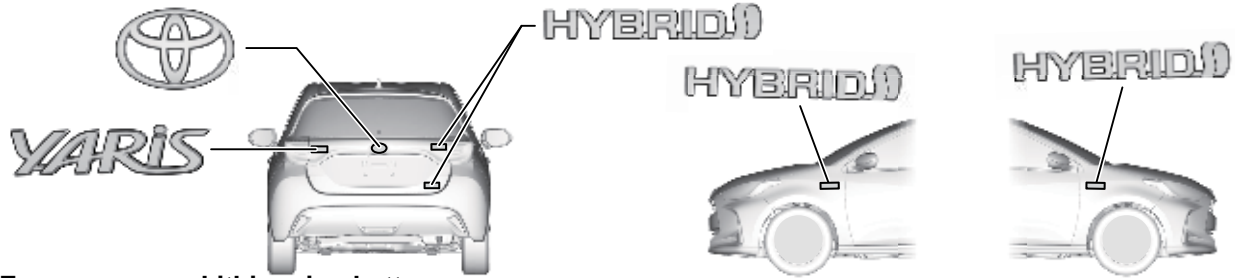

■ Energy source: Lithium-ion battery



2. Immobilisation Stabilisation / Lifting

■ Completely immobilise the vehicle

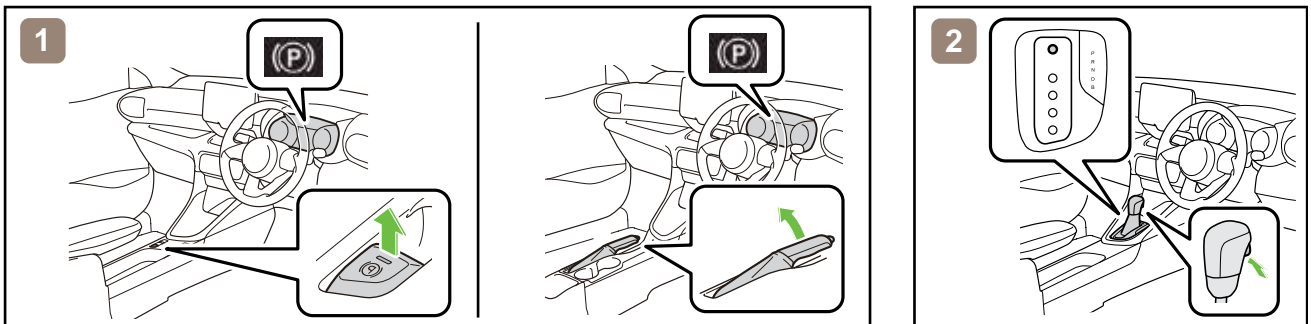

1. Chock the wheels and engage the parking brake.

2. Move the shift lever to the park (P) position.

To stabilise the vehicle, place cribbing such as wooden blocks at the four points under the front and rear pillars.

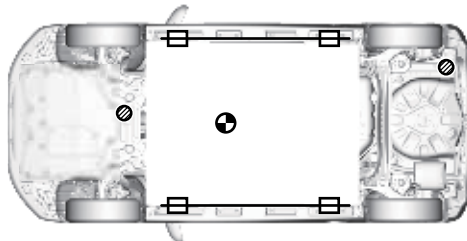

Jack Position

Support Position

Vehicle Center of Gravity



Do not place cribbing such as wooden blocks or rescue air lifting bags under the exhaust system, fuel system or high voltage power cables. Doing so may result in fuel leaks, fire, or electric shock.

3. Disable direct hazards / Safety regulations



Even if the engine is stopped, the vehicle may not be shut off. If the vehicle is not completely shut off, the engine may suddenly start or the vehicle may start to move.

■ If any of the following systems are required to be operated, operate them BEFORE disconnecting the battery.

Power door lock

Power window

Back door opener

Electric parking brake



When the 12 V battery is disconnected, electrical components cannot be operated.

ID No.	Version No.	Version date	Page
YARISHV10	01	03 / 2020	2 / 4

■ Perform procedure 1 or 2 to completely shut off the vehicle.

<Procedure 1>

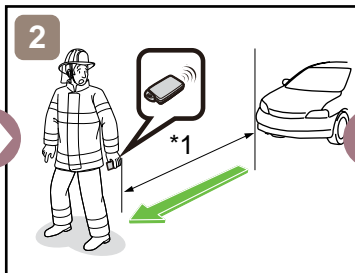
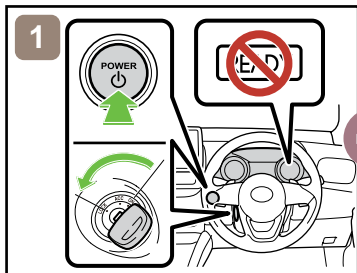
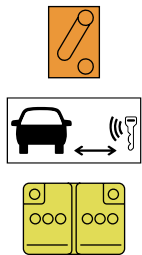

*1: 5 m (16.4 ft) or more

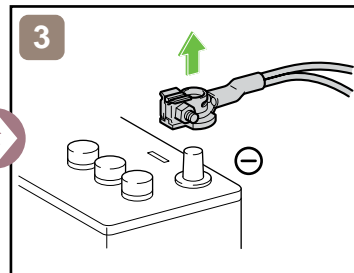

<Procedure 2>

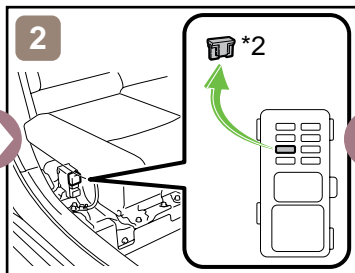
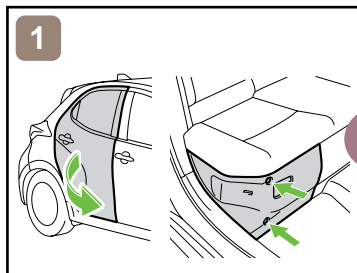
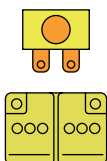

*2: PM-IGCT FUSE (7.5 A BROWN)

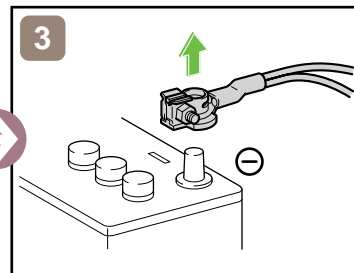

4. Access to the occupants

■ Window Glass

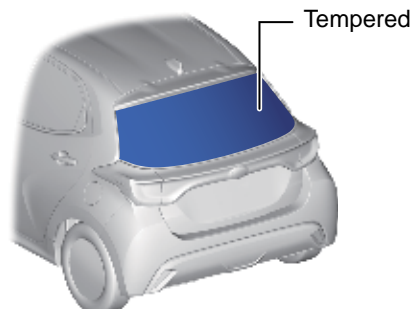
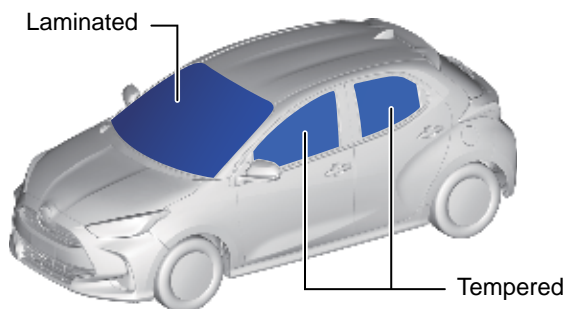

5. Stored energy / Liquids / Gases / Solids



High Voltage Li-ion Battery



12 V Battery



Petrol Tank: 36 L, 33 L



- Always wear appropriate personal protective equipment (PPE) when dealing with any of these items.
- Never breach or remove the battery assembly cover under any circumstances, including fire. Doing so may result in serious injury or death from severe burns or electric shock.

	ID No.	Version No.	Version date	Page
	YARISHV10	01	03 / 2020	3 / 4

6. In case of fire



USE COPIOUS AMOUNTS OF WATER

If it is difficult to apply copious amounts of water to the high voltage battery, it is recommended to allow the high voltage battery to burn itself out.



RE-IGNITION POSSIBLE !



7. In case of submersion



Do not touch any of the high-voltage components or cables, including the service plug, while the vehicle is submerged. Doing so may result in electric shock. Work on the vehicle only after the vehicle has been pulled out of the water.

8. Towing / Transportation / Storage

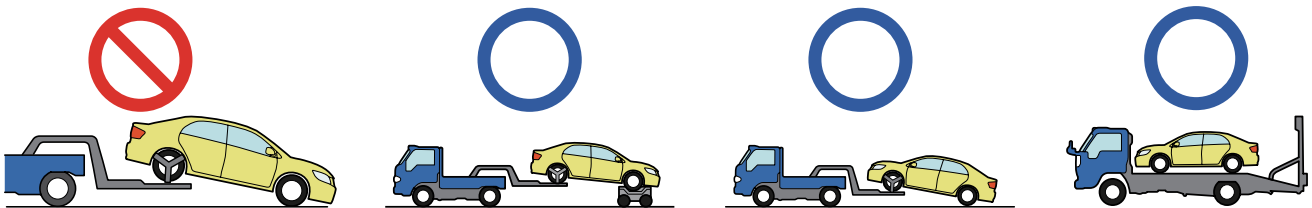

RE-IGNITION POSSIBLE !

Store the vehicle at a safe distance (15 m (49.2 ft) or more) from other vehicles.

9. Important additional information

For further details, please refer to "Emergency Response Guide".

	ID No.	Version No.	Version date	Page
	YARISHV10	01	03 / 2020	4 / 4



TOYOTA YARIS HYBRID
5 doors / 5 seats / hatchback
2024-4

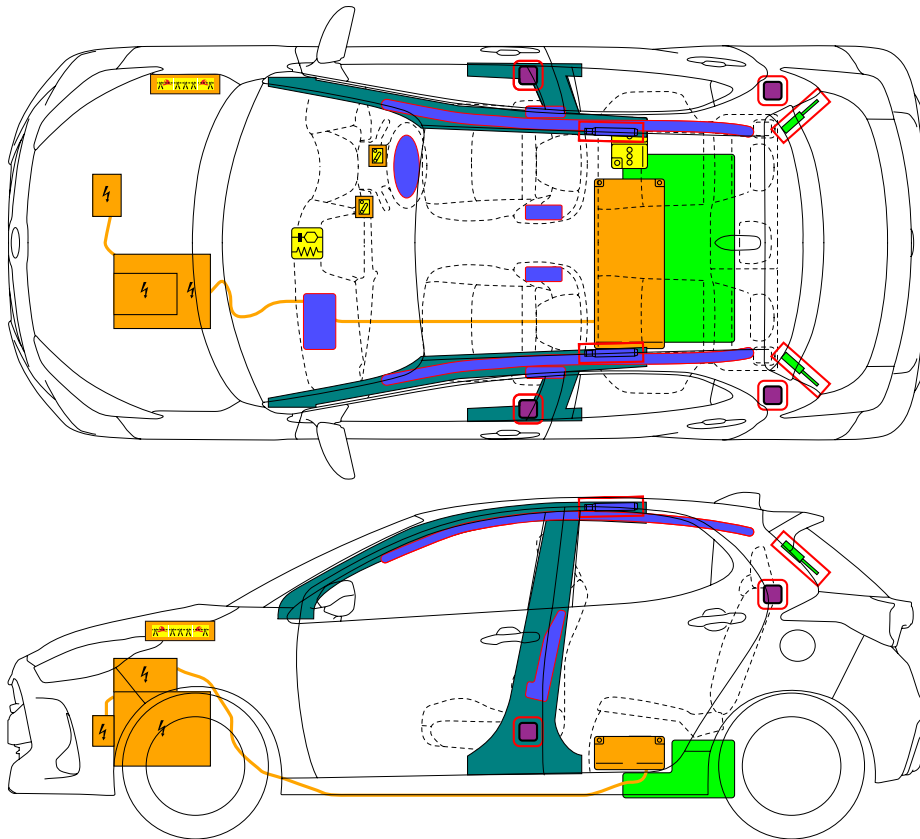

	Airbag		Stored gas inflator		Seat belt pretensioner		SRS control unit		
	Gas strut / Preloaded spring		High strength zone						
	Battery low voltage		Fuel tank						
	High voltage battery pack		High voltage power cable / component		Low voltage device that disconnects high voltage		Cable Cut		High voltage component
	ID No.	Version No.		Version date		Page			
	YARISHV10	02		04 / 2024		1 / 4			

1. Identification / Recognition



Lack of engine noise does not mean vehicle is off. Silent movement or instant restart capability exists until vehicle is fully shut down.

Location of vehicle badges

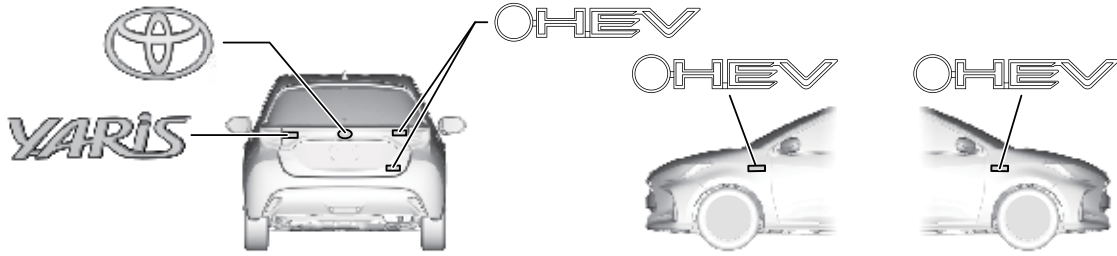

Energy source: Lithium-ion battery



2. Immobilisation / Stabilisation / Lifting

Completely immobilize the vehicle

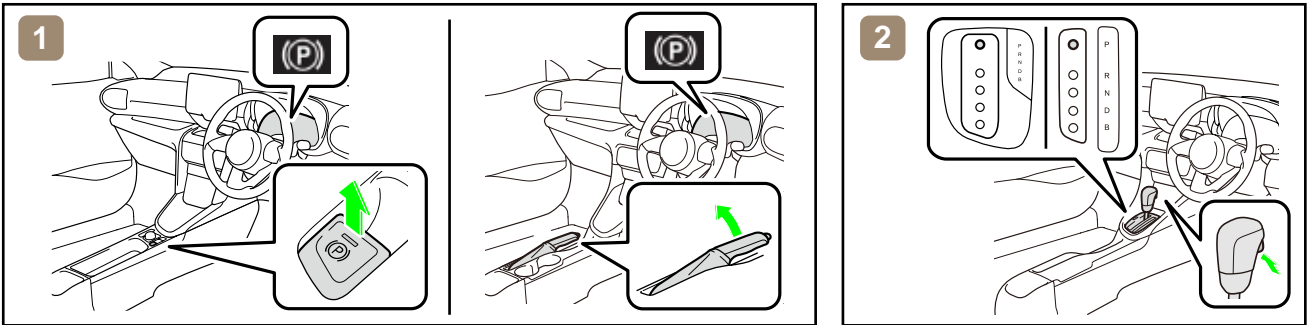

1. Chock the wheels and engage the parking brake.

2. Move the shift lever to the park (P) position.

Stabilisation-lifting point

Place cribbing such as wooden blocks at the four points under the front and rear pillars.

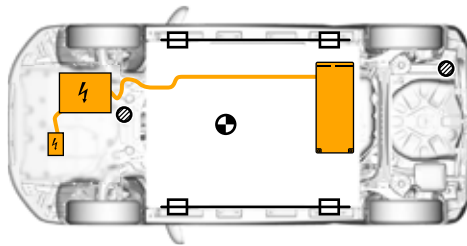

Extra Reinforced Lifting Points



Standard Jack Locations



Vehicle Center of Gravity



Do not place cribbing such as wooden blocks or rescue air lifting bags under the exhaust system, fuel system or high voltage power cables. Doing so may result in fuel leaks, fire, or electric shock.

3. Disable direct hazards / Safety regulations

If any of the following systems are required to be operated, operate them **BEFORE** disconnecting the battery.

Power door lock

Power window

Back door opener

Electric parking brake

When the 12 V battery is disconnected, electrical components cannot be operated.

	ID No.	Version No.	Version date	Page
	YARISHV10	02	04 / 2024	2 / 4

■ Perform procedure Main or Alternative to completely shut off the vehicle.

<Procedure Main>

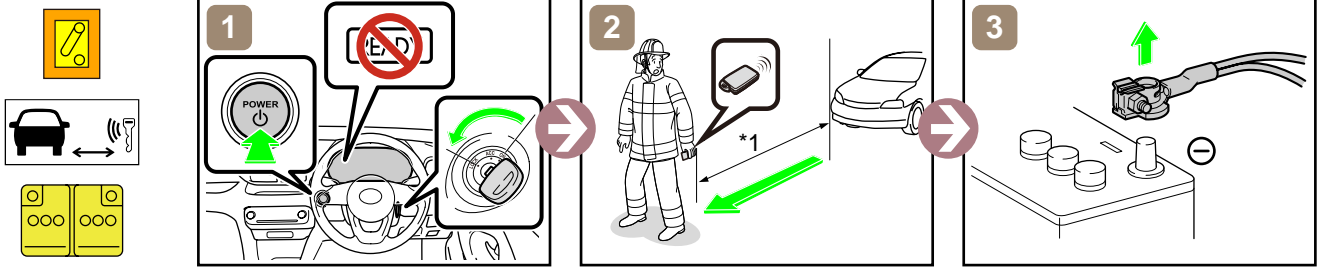

*1: 5 m (16.4 ft) or more

<Procedure Alternative>

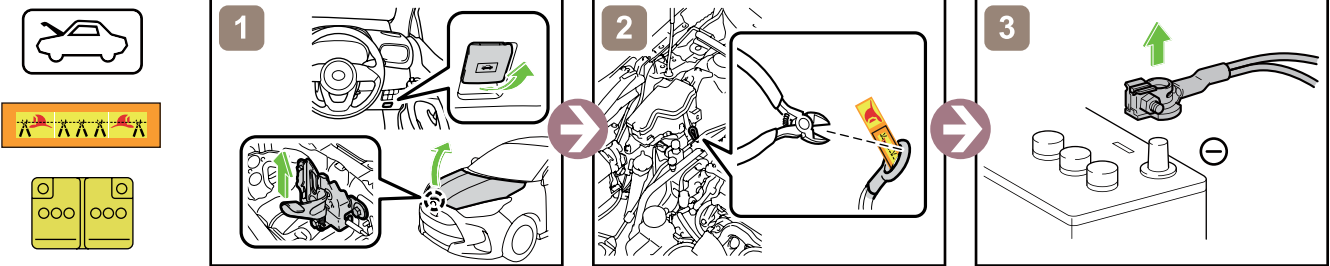

In the event of an accident in which the airbags are deployed, the high-voltage system will be automatically deactivated.

■ Access to 12 V Battery

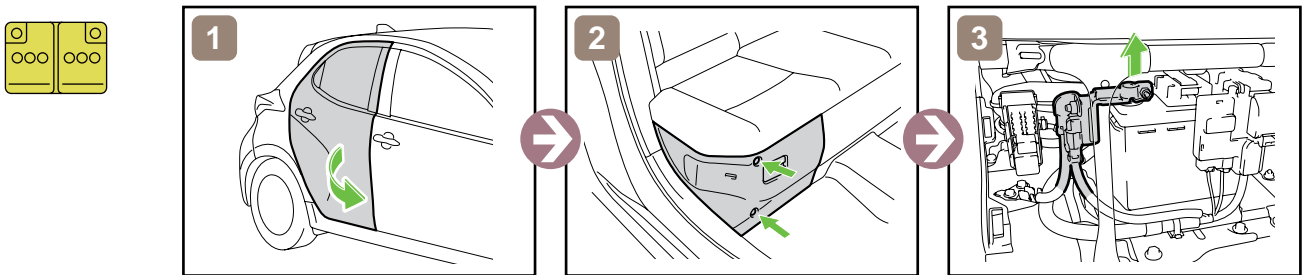

4. Access to the occupants

■ Window Glass

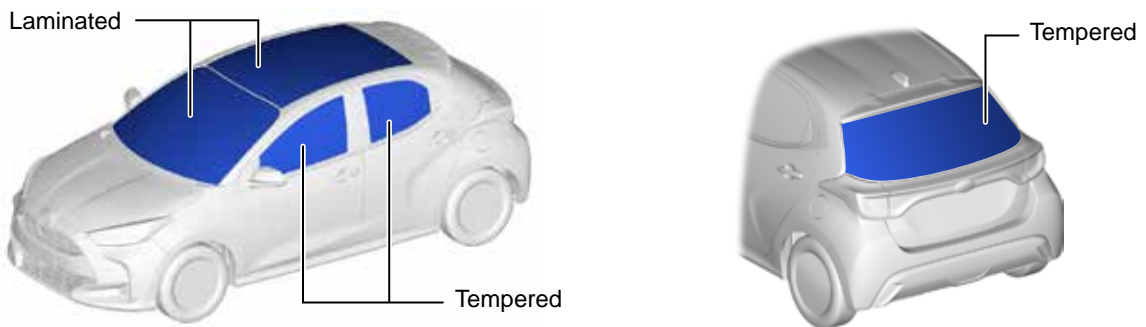

5. Stored energy / Liquids / Gases / Solids



High Voltage Li-ion Battery



12 V Battery



Gasoline Tank: 36 L, 33 L

	ID No.	Version No.	Version date	Page
	YARISHV10	02	04 / 2024	3 / 4



- Always wear appropriate personal protective equipment (PPE) when dealing with any of these items.
- Never breach or remove the battery assembly cover under any circumstances, including fire. Doing so may result in serious injury or death from severe burns or electric shock.

6. In case of fire



USE COPIOUS AMOUNTS OF WATER

If it is difficult to apply copious amounts of water to the high voltage battery, it is recommended to allow the high voltage battery to burn itself out.

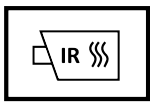

RE-IGNITION POSSIBLE !



7. In case of submersion



Do not touch any of the high-voltage components or cables, including the service plug, while the vehicle is submerged. Doing so may result in electric shock.
Work on the vehicle only after the vehicle has been pulled out of the water.

8. Towing / Transportation / Storage

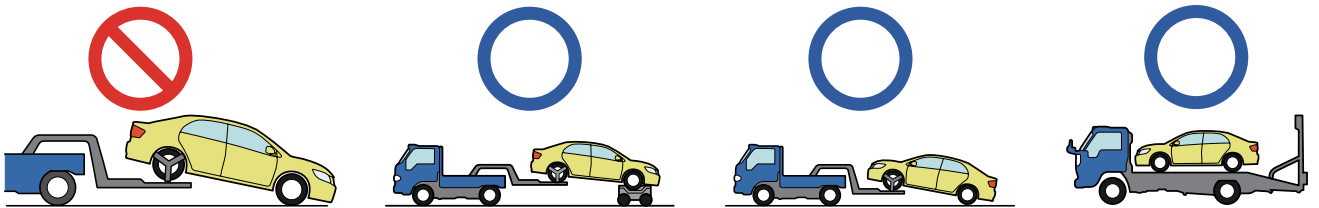

RE-IGNITION POSSIBLE !

Store the vehicle at a safe distance (15 m (49.2 ft) or more) from other vehicles.

9. Important additional information

For further details, please refer to "Emergency Response Guide".

	ID No.	Version No.	Version date	Page
	YARISHV10	02	04 / 2024	4 / 4



TOYOTA GR YARIS

2020-9

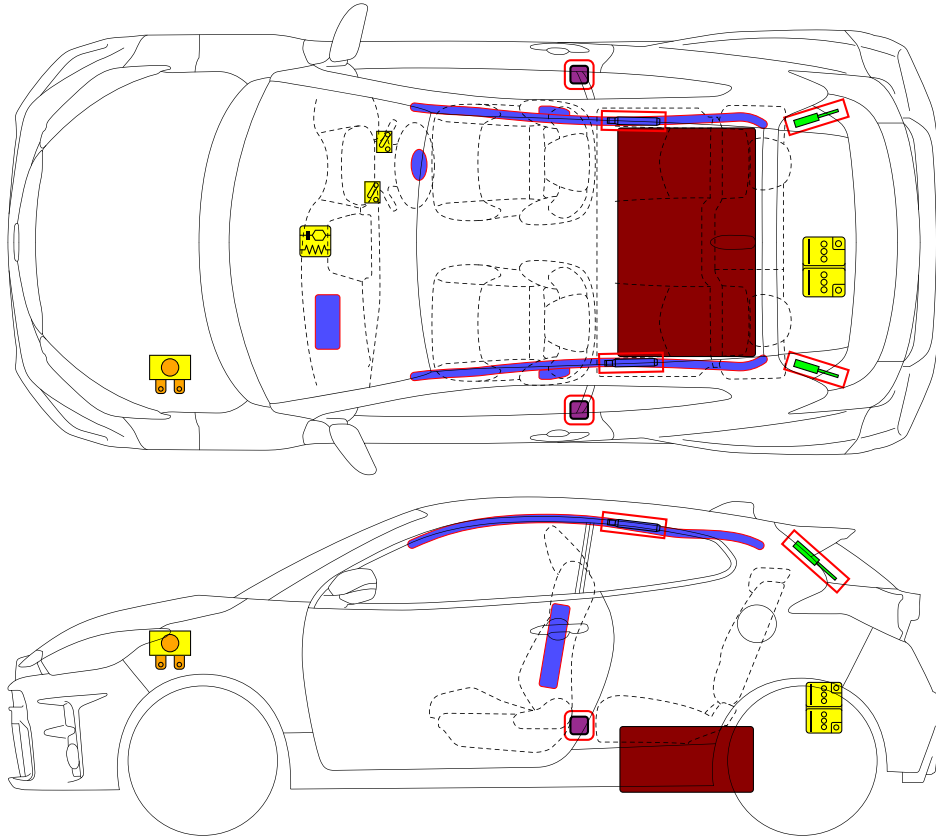
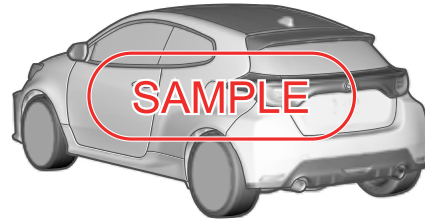
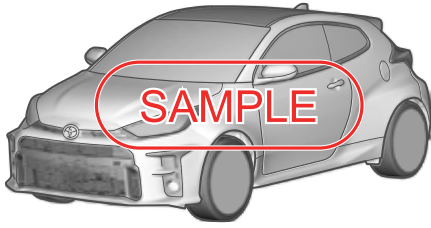

	Airbag		Stored gas inflator		Seat belt pretensioner		SRS control unit		Pedestrian protection active system
	Automatic rollover protection system		Gas strut / Preloaded spring		High strength zone		Zone requiring special attention		
	Battery low voltage		Ultra capacitor, low voltage		Fuel tank		Gas tank		Safety valve
	High voltage battery pack		High voltage power cable / component		High voltage disconnect		Fuse box disabling high voltage system		Ultra capacitor, high voltage
	Device to shut down power in vehicle								
	ID No.	Version No.		Version date		Page			
	GRYARIS16	03		05 / 2025		1 / 4			

1. Identification / Recognition



Lack of engine noise does not mean vehicle is off. Silent movement or instant restart capability exists until vehicle is fully shut down.

Location of vehicle badges

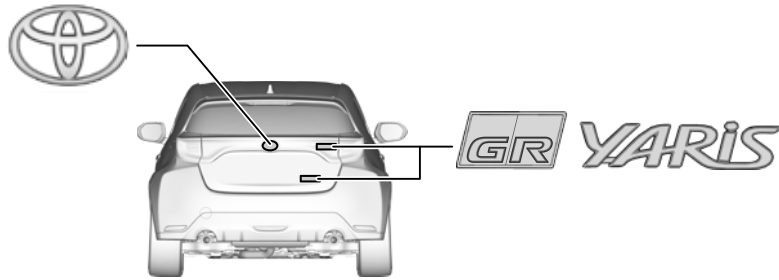

2. Immobilisation / Stabilisation / Lifting

Completely immobilize the vehicle

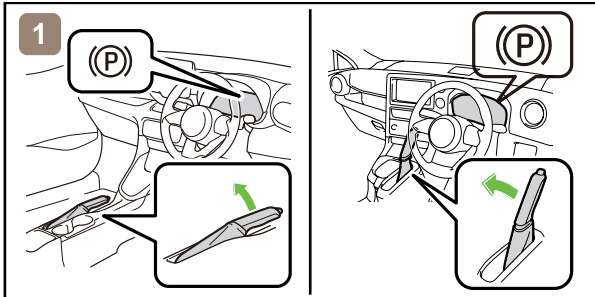

1. Chock the wheels and engage the parking brake.

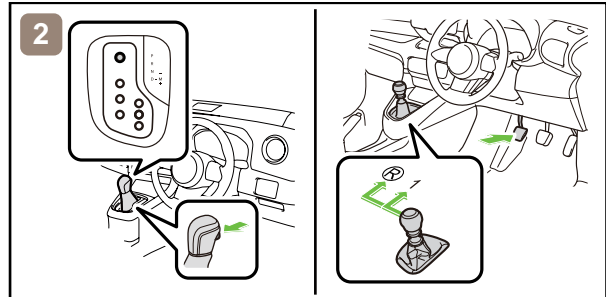

2. Move the shift lever to the park (P) position.*1

2. Depress the clutch pedal and move the shift lever to the 1st or reverse (R) position.*2

*1: A/T

*2: M/T

Stabilisation-lifting point

Place cribbing such as wooden blocks at the four points under the front and rear pillars.

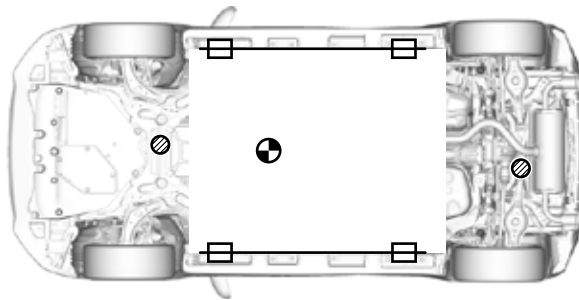

Extra Reinforced Lifting Points



Standard Jack Locations



Vehicle Center of Gravity



Do not place cribbing such as wooden blocks or rescue air lifting bags under the exhaust system or fuel system. Doing so may result in fuel leaks, fire, or electric shock.

3. Disable direct hazards / Safety regulations

If any of the following systems are required to be operated, operate them **BEFORE** disconnecting the battery.

Power door lock

Power window

Back door opener



When the 12 V battery is disconnected, electrical components cannot be operated.

ID No.	Version No.	Version date	Page
GRYARIS16	03	05 / 2025	2 / 4

■ Perform procedure Main or Alternative to completely shut off the vehicle.

<Procedure Main>

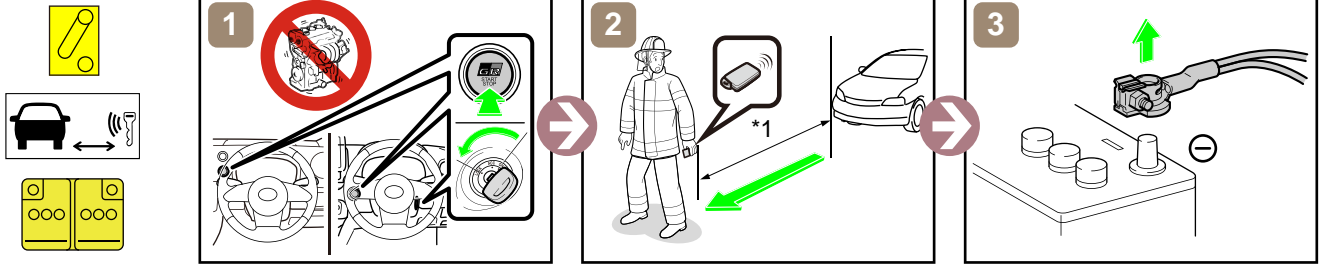

*1: 5 m (16.4 ft) or more

<Procedure Alternative>

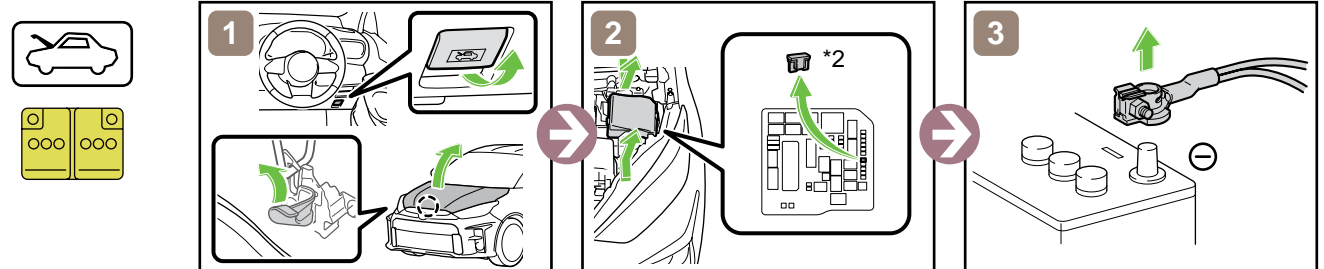

*2: IGP-MAIN (25 A CLEAR)

■ Access to 12 V Battery

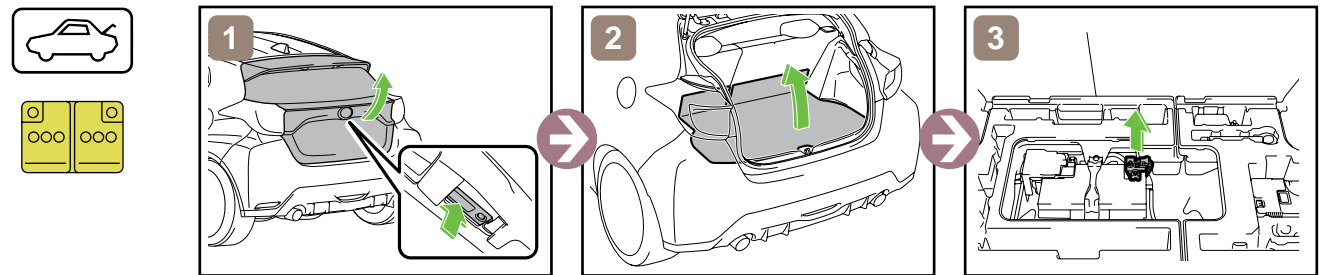

4. Access to the occupants

■ Window Glass



ID No.	Version No.	Version date	Page
GRYARIS16	03	05 / 2025	3 / 4

5. Stored energy / Liquids / Gases / Solids



12 V Battery



Gasoline Tank: 50 L



Always wear appropriate personal protective equipment (PPE) when dealing with any of these items.

6. In case of fire

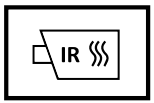

RE-IGNITION POSSIBLE !

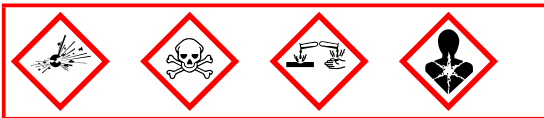

7. In case of submersion



Work on the vehicle only after the vehicle has been pulled out of the water.

8. Towing / Transportation / Storage

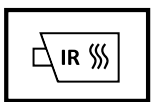
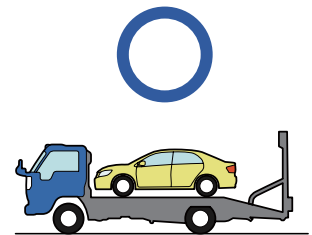
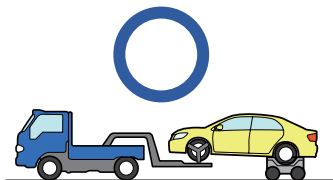

RE-IGNITION POSSIBLE !

Store the vehicle at a safe distance (15 m (49.2 ft) or more) from other vehicles.

9. Important additional information

For further details, please refer to "Emergency Response Guide".

ID No.	Version No.	Version date	Page
GRYARIS16	03	05 / 2025	4 / 4